

Standard Bidding Document

XEN-EHV-TLCLHR-01-2026: CONSTRUCTION AND COMPLETION
OF CIVIL WORKS, ERECTION, STRINGING, TESTING &
COMMISSIONING FOR CONVERSION OF TOWER NOS. 42 & 43 OF
220KV DOUBLE CIRCUIT TWIN BUNDLE T/LINE SHEIKHUPURA-
RAVI CIRCUIT FROM SUSPENSION TO TENSION TYPE
(Works)

National

Single Stage-Two Envelope



April 27, 2026

*Executive Engineer TLC Division (EHV-I), NGC Lahore (National Grid Company (NGC)), Deputy Manager
House# 23- Nargis Block Allama Iqbal Town Lahore., Lahore City, Lahore (District), Lahore Division (Division),
Punjab (Province).*

Phone: +92-335-740-1928, Email: ahmadumardewan@ntdc.com.pk

Table of Contents

Instructions to Bidders	3
Bid Data Sheet	31
Bids Data Sheet (BDS)	32
Eligibility Criteria	38
Evaluation Criteria	38
Jobs/Lots	39
Related Services :	39
Work Specifications and Market Rates	39
Scope of Work	44
Price Schedule	44
General Conditions of Contract	47
Special Conditions of Contract	57
Bid Securing Declaration	63
Contract Form	65
Integrity Pact	68
Performance Guarantee Form	70
Annexure	72
Complete Bidding Document No. XEN-EHV-TLCLHR-01-2026	73
Procurement Forms	74
Past Experience and Completed Contracts	1
Historical Contract Non-Performance, and Pending Litigation and Litigation History	1

Current Contracts and Their Progress	1
Financial Capacity and Net Worth Evaluation Form	1
Average Annual Turnover	1
Additional Forms and Documents	77

REQUEST FOR BIDS
PROCUREMENT OF CIVIL WORKS

1. The **Executive Engineer TLC Division (EHV-I), NGC Lahore (National Grid Company (NGC))** has reserved Funds for the procurement planned for FY 2025-26. The **Executive Engineer TLC Division (EHV-I), NGC Lahore (National Grid Company (NGC))** intends to apply part of the proceeds of this Fund to cover eligible payments under the contract for the "**XEN-EHV-TLCLHR-01-2026: CONSTRUCTION AND COMPLETION OF CIVIL WORKS, ERECTION, STRINGING, TESTING & COMMISSIONING FOR CONVERSION OF TOWER NOS. 42 & 43 OF 220KV DOUBLE CIRCUIT TWIN BUNDLE T/LINE SHEIKHUPURA-RAVI CIRCUIT FROM SUSPENSION TO TENSION TYPE**".

2. The **Executive Engineer TLC Division (EHV-I), NGC Lahore (National Grid Company (NGC))** invites sealed Bids from eligible Bidders for procurement of Works (**XEN-EHV-TLCLHR-01-2026: CONSTRUCTION AND COMPLETION OF CIVIL WORKS, ERECTION, STRINGING, TESTING & COMMISSIONING FOR CONVERSION OF TOWER NOS. 42 & 43 OF 220KV DOUBLE CIRCUIT TWIN BUNDLE T/LINE SHEIKHUPURA-RAVI CIRCUIT FROM SUSPENSION TO TENSION TYPE**) described in the bidding documents on **EPADS v2.0**.

3. **Single Stage-Two Envelope** will be used by adopting **Least Cost Based Selection (LCBS)** Technique for the subject procurement, in line with the Public Procurement Rules, 2004 and any Regulations, Regulatory Guides, Procurement Guidelines or Instructions issued by the Authority from time to time.

4. All Bids must be accompanied by a Bid Security amounting described in Bid Security Section in Bidding Document in the form of **Pay Order, Banker's Cheque, Call at Deposit, Bank Guarantee, Demand Draft**. Or all bids must be accompanied by bid securing declaration in the format specified in the Bidding documents

5. E-Bidding documents, containing detailed terms & conditions, specifications and requirements etc. are available on **e-Pak Acquisition and Disposal System (EPADS)** at <https://vendors.epads.gov.pk/> for all the interested

bidders registered on **EPADS v2.0**. Bidders are required to get themselves registered on **EPADS v2.0** to participate in Bidding process.

6. The e-bids, prepared in accordance with the instructions in the e-Bidding documents, must be submitted through **EPADS v2.0** on or before **Monday, May 18, 2026 11:00 AM**. E-bids will be opened by using **EPADS v2.0** on the same day at **Monday, May 18, 2026 11:30 AM**. Manual submission of Bids shall not be entertained. Those vendor who have not yet registered on the new version of **EPADS v2.0**, may register themselves on <https://pa.epads.gov.pk/>. A tutorial to explain the registration process is available at <https://www.youtube.com/watch?v=MNW6T38v7tc>.

In terms of Rules 48 of Public Procurement Rules, 2004 Grievance Redressal Committee (GRC) is notified for the subject procurement and notification copy is available on the procuring agency's website and on Authority's website at (www.ppra.org.pk).

Executive Engineer TLC Division (EHV-I), NGC Lahore (National Grid Company (NGC)), Deputy Manager
House# 23- Nargis Block Allama Iqbal Town Lahore., Lahore City, Lahore (District), Lahore Division (Division), Punjab (Province).
+92-335-740-1928
ahmadumardewan@ntdc.com.pk



Instructions to Bidders

A. INTRODUCTION

1. Scope of Bid

1.1. The Procuring agency/Employer (PA), as indicated in the Bid Data Sheet (BDS) invites Bids for the execution of Works as specified in the BDS and Section V- Works Requirements. The name, identification, and number of lots (contracts) of this National/ International Competitive Bidding process are specified in the BDS.

2. Source of Funds

2.1. Source of funds as referred in Clause 2 of Bid Data Sheet.

3. Eligible Bidders

3.1. A bidder may be natural person, company or firm or public or semi-public agency of Pakistan or any foreign country, or any combination of them with a formal existing agreement (on Judicial Papers) in the form of a joint venture or consortium. In the case of a joint venture or consortium, all members shall be jointly and severally liable for the execution of the Contract in accordance with the terms and conditions of the Contract. The joint venture or consortium shall nominate a Lead Member as nominated in the BDS, who shall have the authority to conduct all business for and on behalf of any and all the members of the joint venture or consortium during the Bidding process, and in case of award of contract, during the execution of contract. Verifiable copy of the agreement that forms a joint venture, consortium or association shall be required to be submitted as part of the Bid.

Any bid submitted by the joint venture, consortium or association shall indicate the part of proposed contract to be performed by each party and each party shall be evaluated (or post qualified if required) with respect to its contribution only, and the responsibilities of each party shall not be substantially altered without prior written approval of the Procuring Agency and in line with any instructions issued by the Authority.

(The limit on the number of members of JV or Consortium may be prescribed

in BDS, in accordance with the guidelines issued by the PPRA).

3.2. The invitation for bids is open to all prospective bidders subject to any provisions of incorporation or licensing by the respective national/international incorporating agency or statutory body established for that particular trade or business. Procuring agencies shall specify the registration/licensing requirements for the foreign bidder keeping in view the requirement of that business.

3.3. A Bidder shall not have a conflict of interest. All Bidders found to have a conflict of interest shall be disqualified. A Bidders may be considered to have a conflict of interest with one or more parties in this Bidding process, if they:

3.3.1. are associated or have been associated in the past, directly or indirectly with a firm or any of its affiliates which have been engaged by the Procuring agency/Employer to provide consulting services for the preparation of design or technical specifications of the works that are the subject of the bid; or

3.3.2. have controlling shareholders in common; or

3.3.3. receive or have received any direct or indirect subsidy from any of them; or

3.3.4. have the same legal representative for purposes of this Bid; or

3.3.5. have a relationship with each other, directly or through common third parties, that puts them in a position to have access to information about or influence on the bid of another bidder, or influence the decisions of the Procuring agency/Employer regarding this Bidding process; or

3.3.6. Submit more than one bid in this bidding process.

3.4. A Bidder may be ineligible if -

3.4.1. he is declared bankrupt or, in the case of company or firm, insolvent;

3.4.2. payments in favor of the bidder is suspended in accordance with the judgment of a court of law other than a judgment declaring bankruptcy and resulting (in accordance with the national laws) in the total or partial loss of the right to administer and dispose of its property;

3.4.3. the bidder is convicted, by a final judgment of a Court of Law or relevant Professional Statuary Body, of any offence involving professional conduct;

3.4.4. The bidder is debarred/ blacklisted by a national level Procuring agency/Employer and hence debarred due to involvement in corrupt and fraudulent practices, or performance failure or due to breach of bid securing declaration.

3.5. As and when required, bidders shall provide to the Procuring agency/Employer evidence of their eligibility, proof of compliance with the necessary legal requirements to carry out the contract effectively.

3.6. Bidders shall submit proposal relating to the nature, conditions and modalities of sub-contracting wherever the sub-contracting of any elements of the contract is envisaged.

4. Eligible Material and Equipment

4.1. All the material and equipment to be mobilized under the contract shall have their origin in eligible source countries, and all expenditures made under the contract will be limited to such materials and equipment. For this purpose, ineligible countries are stated in the section-IV titled as "Eligible Countries".

B. BIDDING DOCUMENTS

1. Contents of Bidding Documents

1.1. The scope of Works, bidding procedures, and terms and conditions of the contract are prescribed in the bidding documents. In addition to the Invitation for Bids, the bidding documents which should be read in

conjunction with any addenda issued in accordance with ITB 7.1 include:

- Section I -Invitation for Bids
- Section II Instructions to Bidders (ITBs)
- Section III Bid Data Sheet (BDS)
- Section IV Eligible Countries
- Section V Evaluation and Qualification Criteria
- Section VI Works Requirements Technical Specifications & Schedule of Requirements
- Section VII Standard Bidding Forms
- Section VIII General Conditions of Contract (GCC)
- Section IX Particular Conditions of Contract (PCC)
- Section X Contract Forms

1.2. The bidder is expected to examine all instructions, forms, specifications, terms and conditions prescribed in the bidding documents. Failure to furnish all the information required in the bidding documents will be at the bidder's risk and may result in the rejection of his bid.

2. Clarification of Bidding Document, Pre-bid Meeting

2.1. A prospective bidder requiring any clarification of the bidding document may notify the Procuring agency/Employer through EPADS.

2.2. The Procuring agency/Employer shall respond to the request for clarification in accordance with Rule 31 of the Public Procurement Rules 2004.

2.3. Should the Procuring Agency deem it necessary to amend the BIDDING document as a result of a clarification, it shall do so following the procedure under ITB 7.

2.4. If indicated in the BDS, the bidder's designated representative is invited at the bidder's cost to attend a pre-bid meeting at the place, date and time mentioned in the BDS. During this pre-bid meeting, prospective bidders may request clarification of the schedule of requirement, the evaluation criteria or any other aspects of the bidding documents.

2.5. Minutes of the pre-bid meeting, if applicable, including the text of the questions asked by bidders, including those during the meeting (without identifying the source) and the responses given, together with any responses prepared after the meeting will be uploaded on EPADS. Any modification to the bidding documents that may become necessary as a result of the pre-bid meeting shall be made by the Procuring agency/Employer exclusively through the use of an Addendum pursuant to ITB 7. Non-attendance at the pre-bid meeting will not be a cause for disqualification of a bidder.

2.6. The bidder is advised to visit and examine the Site of Works and its surroundings and obtain for itself on its own responsibility all information that may be necessary for preparing the bid and entering into a contract for construction of the Works. The costs of visiting the Site shall be at the bidder's own expense.

2.7. The bidder and any of its authorized personnel will be granted permission by the Procuring agency/Employer to enter upon its premises and lands for the purpose of such visit, but only upon the express condition that the bidder and its personnel will release and indemnify the Procuring agency/Employer from and against all liability in respect thereof, and will be responsible for death or personal injury, loss of or damage to property, and any other loss, damage, costs, and expenses incurred as a result of the inspection.

3. Amendment of Bidding Documents

3.1. The procuring agency may issue notification of any change, addition, modification or deletion in accordance with Rule 23 of the Public Procurement Rules 2004 i.e. Bidding Documents.

3.2. To give prospective bidders reasonable time in which to take an addendum/corrigendum into account in preparing their bids, the Procuring agency/Employer may, at its discretion, extend the deadline for the submission of bids:

Provided that the Procuring agency/Employer shall extend the deadline for submission of bid in pursuance of Rule 27 of the Public Procurement Rules 2004, i.e. Extension of time for submission of bids, if such an addendum is

issued within last three (03) days of the bid submission deadline.

C. PREPARATION OF BIDS

1. Language of Bid

1.1. The bid prepared by the bidder, as well as all correspondence and documents relating to the bid exchanged by the bidder and the Procuring agency/Employer shall be written in the English language unless specified in the BDS. Supporting documents and printed literature furnished by the bidder may be in another language provided they are accompanied by an accurate translation of the relevant pages in the English language unless specified in the BDS, in which case, for purposes of interpretation of the bidder, the translation shall govern.

2. Documents Constituting the Bids

2.1. The Bids prepared by the Bidder shall constitute of all the documents required in the BDS.

3. Documents Establishing Eligibility of Material, Equipment and Works, their Conformity to Bidding Documents

3.1. The bid prepared by the bidder shall constitute the following components: -

3.1.1. Documentary evidence established in accordance with ITB 10 that the material and equipment to be utilized by the Bidder for the executions of works are eligible material and equipment and conform to the Bidding Documents;

3.1.2. Documentary evidence established in accordance with ITB 11 that the bidder has been authorized to carry out the Construction works;

3.1.3. Documentary evidence established in accordance with ITB 11 that the bidder is eligible and/or qualified for the subject bidding process;

3.1.4. Form of Bid and Bid Prices completed in accordance with ITB 12 and 13;

3.1.5. Completed schedules as required, including priced Bill of Quantities in accordance with ITB 13.

3.1.6. Technical Proposal completed in all aspects in accordance with ITB-15.

3.1.7. Bid security or Bid Securing Declaration furnished in accordance with ITB 17;

3.1.8. Any other document required in the BDS.

3.2. In addition to the requirements, bids submitted by a JV shall include a copy of the Joint Venture Agreement entered into by all members. Alternatively, a letter of intent to execute a Joint Venture Agreement in the event of a successful bid shall be signed by all members and submitted with the bid, together with a copy of the proposed Agreement.

3.3. The bidder shall furnish, as part of its bid, all those documents establishing the eligibility in conformity to the terms and conditions specified in the bidding documents for all material, equipment and works which the bidder proposes to execute.

3.4. The documentary evidence of conformity of the material, equipment and works to the Bidding Documents may be in the form of literature, drawings, and data, and shall consist of:

3.4.1. a detailed description of the work methodology, approach, schedule and resources to be mobilized at site;

3.4.2. an item-by-item commentary on the Procuring agency/Employer's Technical Specifications demonstrating substantial responsiveness of the material, equipment and works to those specifications, or a statement of deviations and exceptions to the provisions of the Technical Specifications;

3.4.3. any other procurement specific documentation requirement as stated in the BDS.

3.5. The required documents and other accompanying documents must be in English. In case any other language than English is used the pertinent translation into English shall be attached to the original version.

4. Documents Establishing Eligibility and Qualification of the Bidder

4.1. The bidder shall furnish, as part of its bid, all those documents establishing the bidder's eligibility to participate in the bidding process and/or its qualification to perform the contract if its bid is accepted.

4.2. The documentary evidence of the bidder's eligibility to bid shall establish to the satisfaction of the Procuring agency/Employer that the bidder, at the time of submission of its bid, is from an eligible country as defined in Section-IV titled as "Eligible Countries".

4.3. The documentary evidence of the bidder's qualification to perform the contract if its bid is accepted shall establish to the satisfaction of Procuring agency/Employer that:

4.3.1. The bidder has the financial and technical capability necessary to perform the Contract, meets the qualification criteria specified in Section-V, Evaluation and Qualification Criteria and BDS.

4.3.2. In the case of a bidder not doing business within Pakistan, the bidder is or will be (if awarded the contract) represented by a local bidder (Joint Venture) in accordance with the PEC works bylaws, and in case of award of works such foreign firm is required to participate in the execution of works to carry out its obligations as prescribed in the Conditions of Contract and /or Technical Specifications.

4.3.3. That the bidder meets the qualification criteria listed in Section-V, Evaluation and Qualification Criteria and BDS.

5. Forms of Bid

5.1. The Bidder shall fill the Form of Bids furnished in the bidding documents. The Bids Form must be completed without any alterations to its format and no substitute shall be accepted.

6. Bid Prices

6.1. The bid prices quoted by the bidder in the Standard bid Forms, Bill of Quantities and in the Price Schedules shall conform to the requirements specified below or exclusively mentioned hereafter in the bidding documents.

6.2. The bidder shall fill in rates and prices for all items of the Works described in the Bill of Quantities. If a Price Schedule shows items listed but not priced, their prices shall be construed to be included in the prices of other items in the Bill of Quantities and will not be paid for separately by the Procuring agency/Employer.

6.3. Items not listed in the Price Schedule shall be assumed not to be included in the bid, and provided that the bid is still substantially responsive in their absence or due to their nominal nature, the corresponding average price of the respective item(s) of the remaining substantially responsive bidder(s) shall be construed to be the price of those missing item(s):

Provided that:

6.3.1. where there is only one (substantially) responsive bidder, or

6.3.2. where there is provision for alternate proposals and the respective items are not listed in the other bids,

The Procuring agency/Employer may fix the price of missing items in accordance with market survey, and the same shall be considered as final price.

6.4. The Bid price to be quoted in the Form of Bid in accordance with ITB 12 shall be the total price of the bid.

6.5. Unless otherwise specified in the BDS and the Contract, the rates and prices quoted by the bidder are subject to adjustment during the performance of the Contract in accordance with the provisions of the

Conditions of Contract.

6.6. If so specified in ITB 1.1, bids may be invited for individual lots (contracts) or for any combination of lots (packages).

6.7. Prices quoted by the Bidder shall be fixed during the bidder's performance of the contract and not subject to variation on any account. A bid submitted with an adjustable price will be treated as non-responsive and shall be rejected, pursuant to ITB 27, unless otherwise price adjustment is permissible under Conditions of the Contract.

6.8. All duties, taxes, and other levies payable by the Contractor under the Contract, or for any other cause, as of the date twenty-eight (28) days prior to the deadline for submission of bids, shall be included in the rates and prices and the total bid price submitted by the bidder.

7. Currencies of Bid and Payment

7.1. Prices shall be quoted in Pakistani Rupees unless otherwise specified in the BDS. Comparison of bids and tie of bid shall be treated in accordance with the Rule 30(2) of Public Procurement Rules, 2004.

8. Documents Comprising the Technical Proposal

8.1. The bidder shall furnish a Technical Proposal including a statement of work methods, equipment, personnel, schedule and any other information as stipulated in Section VII - Standard Bid Forms, in sufficient detail to demonstrate the adequacy of the bidder's proposal to meet the work requirements and the completion time.

9. Bid Validity Period

9.1. Bids shall remain valid for the period specified in the BDS after the bid submission deadline prescribed by the Procuring agency/Employer. A bid valid for a shorter period shall be rejected by the Procuring agency/Employer as non-responsive. The period of bid validity will be determined from the complementary bid securing instrument i.e. the expiry period of bid security or bid securing declaration as the case may be.

9.2. Under exceptional circumstances, prior to the expiration of the initial Bids/Bid validity period, the Procuring Agency may request the Bidders' consent to an extension of the period of validity of their Bids/Bid. Such request for extension of the period of bid validity shall be carried out in accordance with Rule 26 of the Public Procurement Rules, 2004.

10. Bid Security or Bid Securing Declaration

10.1. Pursuant to ITB 11.1 unless otherwise specified in the BDS, the bidder shall furnish as part of its bid, a Bid Security in accordance with Rule 25 of the Public Procurement Rules, 2004 in the amount and currency specified in the BDS or Bid Securing Declaration as specified in the BDS in the format provided in Section VII (Standard Bidding Forms).

In case Procuring agency/Employer is inviting bids in lots / packages, the bidder shall be required to submit his bid security against the respective lot/package for which he is submitting his bid.

Until the development of functionality of auto verification of financial instrument in EPADS, the scanned copy of bid security or bid securing declaration, as the case may be, shall be uploaded on E-PADS whereas the original instrument to be submitted to the procuring agency before closing of bid submission deadline,

10.2. The Bid Security shall be denominated in the local currency or in another freely convertible currency, and it shall be in the form specified in the **BDS** which shall be in any of the following:

10.2.1. A bank guarantee, an irrevocable letter of credit issued by a Scheduled bank in the form provided in the Bidding Documents or another form acceptable to the Procuring agency/Employer and valid for twenty-eight (28) days beyond the end of the validity of the Bid. This shall also apply if the period for Bid Validity is extended. In either case, the form must include the complete name of the bidder;

10.2.2. A cashier's or certified cheque; or

10.2.3. Another security as indicated in the **BDS**.

10.3. The Bid Security or Bid Securing Declaration shall be in accordance with the Form of the Bid Security or Bid Securing Declaration included in Section VII (Standard Bidding Forms) or another form approved by the Procuring agency/Employer prior to the bid submission.

10.4. The Bid Security shall be payable promptly upon written demand by the Procuring agency/Employer in case any of the conditions listed in ITB 17.9 are invoked.

10.5. Any bid not accompanied by a Bid Security or Bid Securing Declaration in accordance with ITB 17.1 or 17.3 shall be rejected by the Procuring agency/Employer and shall be declared as non-responsive bid, pursuant to ITB 27.

10.6. Unsuccessful bidders' Bid Security will be discharged or returned as promptly as possible, however in no case later than thirty (30) days after the expiration of the period of Bid Validity prescribed by the Procuring agency/Employer pursuant to ITB 16. The Procuring agency/Employer shall make no claim to the amount of the Bid Security, and shall promptly return the Bid Security document, after whichever of the following that occurs earliest:

10.6.1. The expiry of the Bid Security;

10.6.2. The entry into force of a procurement contract and the provision of a performance security (or guarantee), for the performance of the contract if such a security (or guarantee), is required by the Bidding documents;

10.6.3. The rejection by the Procuring agency/Employer of all Bids;

10.6.4. The withdrawal of the bid prior to the deadline for the submission of bids, unless the bidding documents stipulate that no such withdrawal is permitted.

10.7. The successful bidder's Bid Security will be discharged upon the bidder signing the contract pursuant to ITB 40, or furnishing the performance security (or guarantee), pursuant to ITB 41.

10.8. The Bid Security may be forfeited or the Bid Securing Declaration executed:

10.8.1. if a Bidder:

10.8.1.1. Withdraws its Bid during the period of Bid Validity as specified by the Procuring agency/Employer, and referred by the bidder on the Form of Bid except as provided for in ITB 16.2; or

10.8.2. In the case of a successful bidder, if the bidder fails:

10.8.2.1. to sign the contract in accordance with ITB 40; or

10.8.2.2. to furnish performance security (or guarantee) in accordance with ITB 41.

10.9. In case of Bid Security issued by the foreign bank is allowed by the Procuring agency/Employer, the same should be counter guaranteed by a corresponding bank in Pakistan. Furthermore, in case of joint venture, it should be in the name of Joint venture to ensure joint responsibility. In case the JV is not legally constituted at the time of bid submission, the bid security or bid securing declaration shall be in the names of all future members as named in the letter of bid.

11. Withdrawal of Bids

11.1. Before bid submission deadline, any bidder may withdraw, substitute, or modify its bid after it has been submitted by sending a written notice, duly signed by an authorized representative, and the corresponding must accompany the respective written notice.

12. Format and Signing of Bid

12.1. The Bidder shall prepare and submit Bids through EPADS with due diligence after carefully reading all the terms and condition before bid submission deadline.

D. SUBMISSION OF BIDS

1. **Submission of Bids through EPADS v2.0**

1.1. All bids shall be submitted through EPADS v2.0.

2. **Deadline for Submission of Bids**

2.1. All bids shall be received through **EPADS v2.0** not later than bid submission deadline as specified in the **BDS**.

2.2. The Procuring agency/Employer may, under exceptional circumstances and at its discretion, extend the deadline for the submission of bids, pursuant to Rule 27 of the Public Procurement Rules, 2004. Extension of Time for submission of bid, by amending the Bidding Documents in accordance with ITB 7, in which case all rights and obligations of the Procuring agency/Employer and bidders previously subject to the deadline will thereafter be subject to the new deadline.

3. **Substitution and Modification of bids**

3.1. A bidder may substitute or modify his bid after it has been submitted, provided that written notice of the substitution or modification of the bid, is received by the Procuring agency/Employer prior to the deadline for submission of bids.

3.2. Revised bid may be submitted after the substitution or modification made in the original bid in accordance with the provisions referred in **ITB 18**.

E. **OPENING AND EVALUATION OF BIDS**

1. **Opening of Bids**

1.1. The Procuring Agency will open bids in accordance with Rule 28 of the Public Procurement Rules, 2004 and as specified in the BDS.

2. **Confidentiality**

2.1. Information relating to the examination, clarification, evaluation and comparison of bids and recommendation of contract award shall not be disclosed to bidders or any other persons not officially concerned with such process until the time of the announcement of the respective evaluation report.

3. Clarification of Bids

3.1. Clarification of Bidding Documents shall be carried out in accordance with Rule 31 of the Public Procurement Rules, 2004.

3.2. The alteration or modification in the bid which in any case affect the following parameters will be considered as a change in the substance of a bid:

- 3.2.1. evaluation & qualification criteria;
- 3.2.2. required scope of work;
- 3.2.3. contract price;
- 3.2.4. all securities requirements;
- 3.2.5. tax requirements;
- 3.2.6. terms and conditions of bidding documents.
- 3.2.7. change in the ranking of the bidder

4. Preliminary Examination of Bids

4.1. Prior to the detailed evaluation of bids, the Procuring agency/Employer will determine whether each bid:

- 4.1.1. meets the eligibility criteria defined in **ITB 3** and **ITB 4**;
- 4.1.2. has been prepared as per the format and contents defined by the Procuring agency/Employer in the bidding documents;
- 4.1.3. has been properly signed;

4.1.4. is accompanied by the required securities; and

4.1.5. is substantially responsive to the requirements of the bidding documents.

The Procuring agency/Employer's determination of a bid's substantial responsiveness will be based on the contents of the bid itself.

4.2. A substantially responsive Bid is one which conforms to all the terms, conditions, and specifications of the Bidding Documents, without material deviation or reservation. A material deviation or reservation is one that: -

4.2.1. affects in any substantial way the scope, quality, or performance of the Works;

4.2.2. limits in any substantial way, inconsistent with the bidding documents, the Procuring agency/Employer's rights or the bidders' obligations under the Contract; or

4.2.3. if rectified, would affect unfairly the competitive position of other bidders presenting substantially responsive bids.

4.3. The Procuring agency/Employer will confirm that the documents and information specified under ITB 9, 10 and 11 have been provided in the bid. If any of these documents or information is missing, or is not provided in accordance with the Instructions to Bidders, the bid shall be rejected.

4.4. The Procuring agency/Employer may waive-off any minor informality, nonconformity, or irregularity in a bid which does not constitute a material deviation, provided such waiver does not prejudice or affect the relative ranking of any Bidder.

Explanation: A minor informality, non-conformity or irregularity is one that is merely a matter of form and not of substance. It also pertains to some immaterial defect in a Bid or variation of a bid from the exact requirements of the invitation that can be corrected or waived without being prejudicial to other bidders. The defect or variation is immaterial when the effect on quantity, quality, or delivery is negligible when contrasted with the total cost or scope of the works. The Procuring agency/Employer either shall give the bidder an opportunity to cure any deficiency resulting from a minor

informality or irregularity in a bid or waive the deficiency, whichever is advantageous to the Procuring agency/Employer. Examples of minor informalities or irregularities include failure of a bidder to –

4.4.1. Submit the number of copies of signed bids required by the invitation;

4.4.2. Furnish required information concerning the number of its employees;

4.4.3. the firm submitting a bid has formally adopted or authorized, before the date set for opening of bids, the execution of documents by typewritten, printed, or stamped signature and submits evidence of such authorization and the bid carries such a signature.

4.5. Provided that a Technical Bid is substantially responsive, the Procuring agency/Employer may request the bidder to submit the necessary information or documentation, within a reasonable period of time, to rectify nonmaterial nonconformities or omissions in the Technical Bid related to documentation requirements. Requesting information or documentation on such nonconformities shall not be related to any such aspect of the technical Proposal linked with the ranking of the bidders. Failure of the bidder to comply with the request may result in the rejection of its bid.

4.6. Provided that a Technical Bid is substantially responsive, the Procuring agency/Employer shall rectify quantifiable nonmaterial nonconformities or omissions related to the Financial Proposal. To this effect, the Bid Price shall be adjusted, for comparison purposes only, to reflect the price of the missing or nonconforming item or component.

4.7. If a bid is not substantially responsive, it will be rejected by the Procuring agency/Employer and may not subsequently be evaluated for complete technical responsiveness.

5. Examination of Terms and Conditions; Technical Evaluation

5.1. The Procuring agency/Employer shall examine the bid to confirm that all terms and conditions specified in the **GCC** and the **PCC** have been accepted

by the bidder without any material deviation or reservation.

For this purpose:

“Deviation” means departure from the requirements specified in the Bidding Document.

“Reservation” means setting of limiting conditions or withholding from complete acceptance of the requirements specified in the Bidding Document.

5.2. The Procuring agency/Employer shall evaluate the technical aspects of the bid submitted in accordance with ITB 30, to confirm that all requirements specified in Section VI – Works Requirement, Technical Specifications of the Bidding Documents have been met without material deviation or reservation.

5.3. If after the examination of the terms and conditions and the technical evaluation, the Procuring agency/Employer determines that the bid is not substantially responsive in accordance with ITB 27, it shall reject the bid.

6. Correction of Arithmetic Errors

6.1. Bids determined to be substantially responsive will be checked for any arithmetic errors. Errors will be corrected as follows: -

6.1.1. if there is a discrepancy between unit prices and the sub-total price that is obtained by multiplying the unit price and quantity, the unit price shall prevail, and the sub-total price shall be corrected, unless in the opinion of the Procuring agency/Employer there is an obvious misplacement of the decimal point in the unit price, in which the total price as quoted shall govern and the unit price shall be corrected;

6.1.2. if there is an error in a total corresponding to the addition or subtraction of sub-totals, the sub-totals shall prevail, and the total shall be corrected; and

6.1.3. where there is a discrepancy between the amounts in figures and in words, the amount in words will govern.

6.1.4. Where there is discrepancy between grand total of price schedule and amount mentioned on the Form of Bid, the amount referred in Price Schedule shall be treated as correct subject to elimination of other errors.

6.2. The amount stated in the Bid will, be rectified by the Procuring agency/Employer in accordance with the above procedure for the correction of errors and, with, the concurrence of the bidder, shall be considered as binding upon the bidder. If the bidder does not accept the corrected amount, its bid shall be rejected after forfeiture of Bid Security or execution of the Bid Securing Declaration, as the case may be, in accordance with **ITB 41.3**.

7. Conversion to Single Currency

7.1. The unit rates and the prices shall be quoted by the bidder entirely in Pak rupees. A bidder expecting to incur expenditures in other currencies for inputs to the Works from outside the Procuring agency/Employer's country (referred to as the "Foreign Currency Requirements") shall indicate the same in the letter of bid-financial proposal. The proportion of the Bid Price (excluding Provisional Sums) needed by him for the payment of such Foreign Currency Requirements either (i) entirely in the currency of the Bidder's home country or, (ii) at the bidder's option, entirely in Pak rupees provided always that a bidder expecting to incur expenditures in a currency or currencies other than those stated in (i) and (ii) above for a portion of the foreign currency requirements, and wishing to be paid accordingly, shall indicate the respective portions in his bid. Comparison of bids quoted in different currencies and conversion of bids into a single currency shall be carried out in accordance with Rule 30(2) of the Public Procurement Rules, 2004.

8. Evaluation of Bids

8.1. The Procuring agency/Employer shall evaluate and compare only the bids determined to be substantially responsive, pursuant to **ITB 27**.

8.2. In evaluating the Technical Proposal of each Bid, the Procuring agency/Employer shall use the criteria and methodologies listed in the BDS

and in terms of works requirement. No other evaluation criteria or methodologies shall be permitted.

8.3. The Procuring agency/Employer's evaluation of a bid will take into account:

8.3.1. the bid price, excluding provisional sums and the provision, if any, for contingencies in the summary bill of quantities, but including day work items, where priced competitively;

8.3.2. converting the amount resulting from applying above, if relevant, to a single currency in accordance with ITB 29;

8.4. The estimated effect of the price adjustment provisions of the Conditions of Contract, applied over the period of execution of the Contract, shall not be taken into account in bid evaluation.

8.5. If these bidding documents allow bidders to quote separate prices for different lots, and the award to a single bidder of multiple lots, the methodology of evaluation to determine the lowest evaluated lot combinations in the Form of Bid, is specified in the **BDS**.

8.6. If the bid, which results in the Evaluated Bid Price (Successful Bid), is seriously unbalanced or front loaded in the opinion of the Employer, the Employer may require the Bidder to produce detailed price analyses for any or all items of the Bill of Quantities, to demonstrate the internal consistency of those prices with the construction methods and schedule proposed. After evaluation of the price analyses, taking into consideration the schedule of estimated Contract payments, the Employer may require that the amount of the performance security be increased at the expense of the Bidder to a level sufficient to protect the Employer against financial loss in the event of default of the successful Bidder under the Contract.

Explanation:

"Unbalanced" or "front-loaded" bids consist of deliberately submitting bids with artificially high prices or unit rates for the early stages of a construction project, offset by artificially low prices or unit rates for the later stages of the project, to improve the contractor's cash flow.

9. Domestic Preference

9.1. If the **BDS** so specifies, the Procuring agency/Employer will grant a margin of preference to the domestic contractor in line with the rules, regulations, regulatory guides or instructions issued by the Authority from time to time.

10. **Determination of Successful Bid**

10.1. The Procuring agency/Employer shall compare the evaluated bids in accordance with the predefined bidding procedure, of all substantially responsive bids to determine the Successful bidder.

11. **Qualification of Bidder**

11.1. The Procuring agency/Employer shall determine to its satisfaction whether the bidder is substantially responsive and whose bid is declared as Successful bid either continues to meet (if prequalification applies) or meets (if post-qualification applies) the qualifying criteria specified in Evaluation and Qualification Criteria.

Note: In case of international bidding, the parameters for incorporation or licensing within Pakistan may be fulfilled as part of post qualification.

11.2. The determination shall be based upon an examination of the documentary evidence of the bidder's qualifications submitted by the bidder, pursuant to **ITB 11**.

11.3. Prior to contract award, the Procuring agency/Employer will verify that the successful bidder (including each member of a JV) is not blacklisted/debarred. The Procuring agency/Employer will conduct the same verification for each sub-contractor proposed by the successful bidder.

12. **Sub-Contractors**

12.1. The bidder shall provide details regarding any specialized sub-contractor to the Procuring agency/Employer. In case change of sub-contractors, the bidder shall promptly notify the Procuring agency/Employer and obtain approval for replacement of sub-contractors.

12.2. Bidders may propose sub-contracting up to the percentage of total value of contracts or the volume of works as specified in the **BDS**.

13. **Abnormally Low Financial Bid**

13.1. A procuring Agency may reject abnormally low bids. The decision of the Procuring agency/Employer to reject a bid and reasons for the decision shall be recorded in the procurement proceedings and promptly communicated to the bidder concerned. Moreover, the Procuring agency/Employer shall not incur any liability solely by rejecting abnormally bid

Guidance for Procuring agency/Employer:

An abnormally low bid means, in the light of the Procuring agency/Employer's estimate and of all the bids submitted, the bid appears to be abnormally low by not providing a margin for normal levels of profit. In order to identify the Abnormally Low Bid (ALB) following approaches can be considered to minimize the scope of subjectivity:

13.1.1. Comparing the bid price with the cost estimate;

13.1.2. Comparing the bid price with the bids offered by other bidders submitting substantially responsive bids; and

13.1.3. Comparing the bid price with prices paid in similar contracts in the recent past either government- or development partner-funded.

13.2. The Procuring agency/Employer will determine to its satisfaction whether the bidder that is selected as having submitted the successful bid is qualified to perform the contract satisfactorily, in accordance with the criteria listed in **ITB 11**

13.3. The determination will take into account the bidder's financial and technical capabilities. It will be based upon an examination of the documentary evidence of the bidder's qualifications submitted by the bidder, pursuant to **ITB 11**, as well as such other information as the Procuring agency/Employer deems necessary and appropriate. Factors not included in these bidding documents shall not be used in the evaluation of the bidders' qualifications.

13.4. Procuring agency/Employer may seek “Certificate for Independent Price Determination” from the bidder and the results of reference checks may be used in determining award of contract.

Explanation: The Certificate shall be furnished by the bidder. The bidder shall certify that the price is determined keeping in view of all the essential aspects such as raw material, its processing, value addition, optimization of resources due to economy of scale, transportation, insurance and margin of profit etc.

13.5. An affirmative determination will be a prerequisite for award of the contract to the bidder. A negative determination will result in rejection of the bidder’s bid, in which event the Procuring agency/Employer will proceed to the next ranked bidder to make a similar determination of that bidder’s capabilities to perform satisfactorily.

F. AWARD OF CONTRACT

1. Criteria of Award

1.1. Subject to **ITB 36 and 37**, the Procuring agency/Employer will award the Contract to the bidder whose bid has been determined to be substantially responsive to the bidding documents and who has been declared as Successful Bidder, provided that such bidder has been determined to be:

1.1.1. eligible in accordance with the provisions of **ITB 3**;

1.1.2. is determined to be qualified to perform the Contract satisfactorily;
and

1.1.3. Successful negotiations have been concluded, if any.

2. Negotiations

2.1. The Committee of the Procuring agency/Employer may negotiate with the Most Advantageous Bidder relating to the following areas:

2.1.1. a minor alteration to the technical (drawings, design technical specifications) details of the statement of works;

2.1.2. Methodology, work plan, staffing in view to streamline the work;

2.1.3. a minor amendment to the Particular conditions of Contract;

2.1.4. finalizing payment arrangements;

2.1.5. clarifying details that were not apparent or could not be finalized at the time of Bidding;

2.2. Where negotiation fails to result into an agreement, the Procuring agency/Employer may invite the next ranked bidder for negotiations. Where negotiations are commenced with the next ranked bidder, the Procuring agency/Employer shall not reopen earlier negotiations.

3. Procuring agency's Right to reject All Bids

3.1. The procuring agency has the right to reject all bids in accordance with Rule 33 of the Public Procurement Rules, 2004. However, the Authority (i.e. **PPRA**) may call from the Procuring agency/Employer the justification of those grounds.

4. Notification of Award

4.1. The procuring agency shall announce and publish the evaluation result in accordance with Rule 35 of the Public Procurement Rules, 2004.

4.2. Where no complaints have been lodged, the bidder whose bid has been accepted will be notified of the award by the Procuring agency/Employer prior to expiration of the bid validity period through EPADS. However, the Procuring agency/Employer shall not award any procurement contract at least for five (05) days after the announcement of final evaluation report. The notification letter (herein after and in the condition of the contract and contract form called "Letter of Acceptance" will specify the sum that the Procuring agency/Employer will pay the successful bidder in consideration for the execution and completion of the works as prescribed by the Contract

(hereinafter and in the Contract called the "Contract Price).

4.3. The notification of award will constitute the formation of the Contract, subject to the bidder furnishing the Performance Security (or guarantee) in accordance with **ITB 41** and signing of the contract in accordance with **ITB 40**.

4.4. Upon the successful bidder's furnishing of the performance security (or guarantee) pursuant to **ITB 41**, the Procuring agency/Employer will promptly notify each unsuccessful bidder, the name of the successful bidder and the Contract amount and will discharge the Bid Security or Bid Securing Declaration of the bidder(s) pursuant to **ITB 17**.

5. Signing of Contract

5.1. Promptly after notification of award, Procuring agency/Employer shall send the successful bidder the draft agreement, incorporating all terms and conditions as agreed by the parties to the contract.

5.2. Immediately after the Redressal of grievance by the **GRC**, and after fulfillment of all conditions precedent of the Contract Form, the successful bidder and the Procuring agency/Employer shall sign the contract.

5.3. Where no formal signing of a contract is required, work order issued to the bidder shall be construed to be the contract.

6. Performance Security (or Guarantee)

6.1. After the receipt of the Letter of Acceptance, the successful bidder, within the specified time, shall deliver to the Procuring agency/Employer a Performance Guarantee in the amount and in the form stipulated in the BDS and PCC, denominated in the type and proportions of currencies in the Letter of Acceptance and in accordance with the Conditions of Contract.

6.2. If the Performance Guarantee is provided by the successful bidder and it shall be in the form specified in the BDS which shall be in any of the following:

6.2.1. certified cheque, cashier's or manager's cheque, or bank draft;

6.2.2. irrevocable letter of credit issued by a scheduled bank of Pakistan or in the case of an irrevocable letter of credit issued by a foreign bank, the letter shall be confirmed or authenticated by a scheduled bank of Pakistan;

6.2.3. bank guarantee confirmed by a reputable local bank or, in the case of a successful foreign bidder, bonded by a foreign bank; or

6.2.4. surety bond callable upon demand issued by any reputable surety or insurance company.

Any Performance Guarantee submitted shall be enforceable in Pakistan.

6.3. Failure of the Most Advantageous Bidder to comply with the requirement of **ITB 40** shall constitute sufficient grounds for the annulment of the award and forfeiture of the Bid Security or declare blacklisted (in case bid securing declaration is submitted) in which event the Procuring agency/Employer may make the award to the next most advantageous bidder or reinitiate the procurement process afresh (as a case may be).

7. Advance Payment

7.1. Advance payment will be provided to the bidder in percentage and in the manner as agreed by the both parties in terms of Conditions of the Contract.

7.2. The Procuring agency/Employer will provide an advance payment as stipulated in the Conditions of Contract, subject to a maximum amount, as stated and/or Conditions of the Contract. The advance payment request shall be accompanied by an advance payment security (guarantee) in the form provided in Section X. For the purpose of receiving the advance payment, the bidder shall make and estimate of, and include in its bid, the expenses that will relate to the purchase of equipment, machinery, materials, and on the engagement of labor during the first month beginning with the date of the Procuring agency/Employer's "**Notice to Commence**" as specified in the **PCC**.

8. General Performance of the Bidders

8.1. The Procuring agency/Employer reserves the right to obtain information regarding performance of the bidders on their previously awarded contracts / works. The Procuring agency/Employer may seek information / report from the previous employer for consideration. However, the Procuring agency/Employer shall incorporate such parameters in the evaluation criteria and accordingly decide the fate of the bid submitted.

9. Corrupt & Fraudulent Practices

9.1. Procuring agencies (including beneficiaries of Government funded projects and procurement) as well as Bidders/Suppliers/Contractors under Government financed contracts, observe the highest standard of ethics during the procurement and execution of such contracts, and will avoid to engage in any corrupt and fraudulent practices.

G. GRIEVANCE REDRESSAL & COMPLAINT REVIEW MECHANISM

1. Grievance Redressal

1.1. Grievance Redressal shall be carried out in accordance with Rule 48 of the Public Procurement Rules, 2004 i.e. Redressal of grievances by the procuring agency and "Redressal of Grievances Regulations 2021".

H. MECHANISM OF BLACKLISTING

1. Mechanism of Blacklisting

1.1. The Procuring agency/Employer shall proceed Blacklisting of Bidders/Contractors in accordance with Rule 19 of the Public Procurement Rules, 2004 i.e. Blacklisting and "Blacklisting and Debarment of Bidders or Contractors Regulations 2024".



Bid Data Sheet

Bids Data Sheet (BDS)

The following specific data for the procurement of Goods to be procured shall complement, supplement, or amend the provisions in the Instructions to Bidders (ITB). Whenever there is a conflict, the provisions herein shall prevail over those in ITB.

BDS Clause Number	ITB Number	Amendments of, and Supplements to, Clauses in the Instruction to Bidders
A. Introduction		
1	1.1	<p>Name of Procuring Agency:Executive Engineer TLC Division (EHV-I), NGC Lahore (National Grid Company (NGC))</p> <p>The subject of procurement is:XEN-EHV-TLCLHR-01-2026: CONSTRUCTION AND COMPLETION OF CIVIL WORKS, ERECTION, STRINGING, TESTING & COMMISSIONING FOR CONVERSION OF TOWER NOS. 42 & 43 OF 220KV DOUBLE CIRCUIT TWIN BUNDLE T/LINE SHEIKHUPURA-RAVI CIRCUIT FROM SUSPENSION TO TENSION TYPE</p> <p>Expected commencement date: Thursday, June 25, 2026</p>
2.	2.1	<p>Financial year for the operations of the Procuring Agency:2025-26</p> <p>Name and identification number of the Contract: P24206</p>
3.	3.1	<p>JV/Consortium or Association Allowed: Yes</p> <p>Number of JV/Consortium Members: 3</p>

B. Bidding Documents

4.	6.2 & 6.4	The Bidders may seek clarifications through EPADS v2.0 : Clarification Date: Thursday, May 14, 2026 Pre-Bid Meeting: Monday, May 4, 2026 11:00 AM Venue: House# 23- Nargis Block Allama Iqbal Town Lahore.
5.	7.2	Any addendum, in case issued, shall be published on Executive Engineer TLC Division (EHV-I), NGC Lahore (National Grid Company (NGC)) website and on EPADS v2.0 .
C. Preparation of Bids		

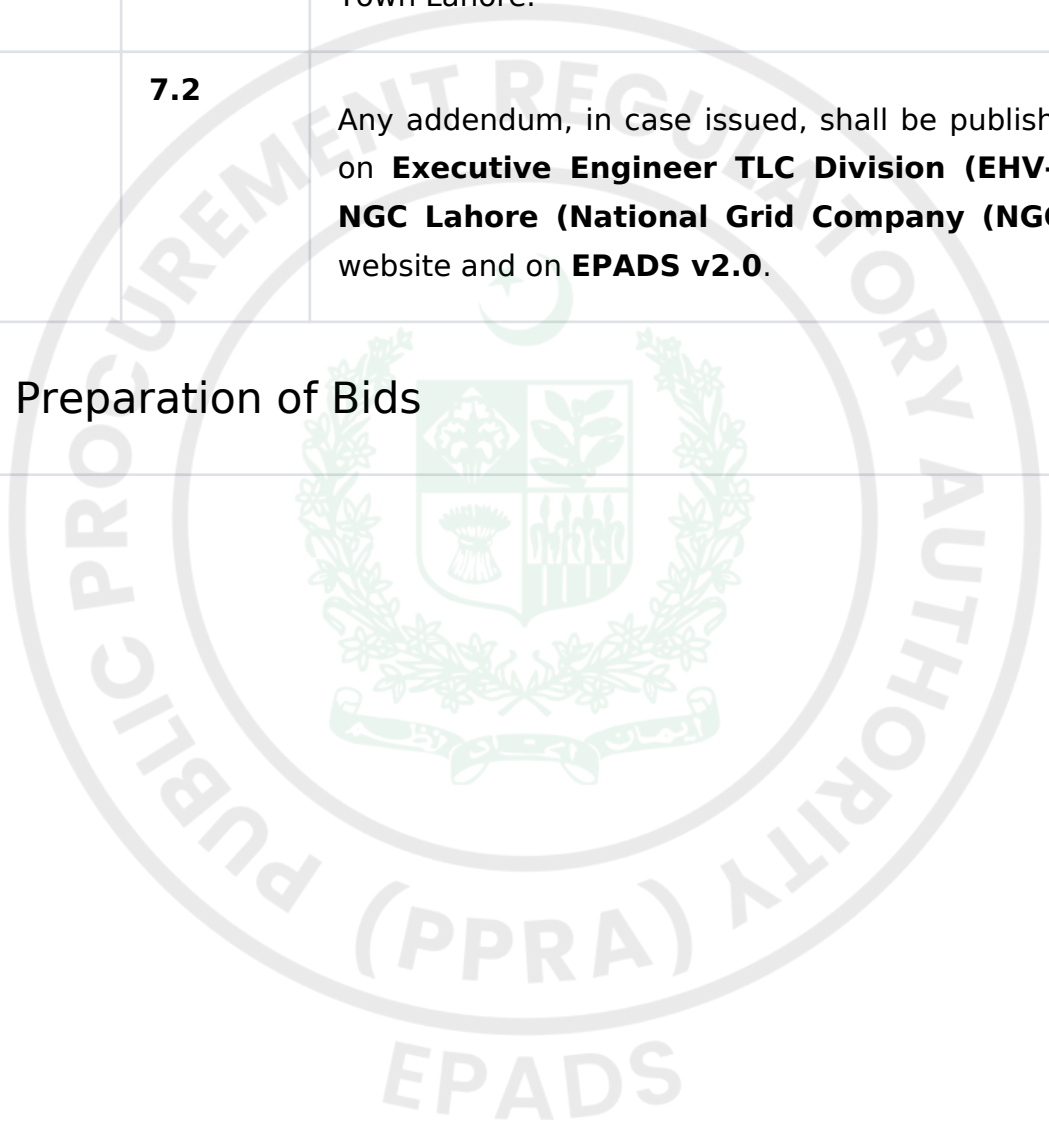

6.

8.1

List of documents required along with the bid:

1. i) Appendix-A to Bid Special Stipulations ii) Appendix-C to Bid Price Adjustment is not applicable iii) Appendix-E to Bid Proposed Construction Schedule iv) Appendix-F to Bid Method of Performing the Work v) Appendix-G to Bid Proposed Personnel vi) Appendix-H to Bid List of Major Equipment-Related Items vii) Appendix-I to Bid Construction Camp and Housing Facilities

2. viii) Appendix-J to Bid Organizational Chart of the Supervisory Staff and Labor ix) Appendix-K to Bid List of Sub-Contractors x) Appendix-L to Bid Source of Materials xi) Appendix-N to Bid Deviations xii) Appendix-O to Bid Integrity Pact xiii) Appendix-P to Bid Bidder's Qualification Forms

3. b) Bid Security as per requirements specified in Section-I Clause IB 15. c) Written Power of Attorney, duly notarized, authorizing the signatory of the bid to act for and on behalf of the Bidder; d) Copies of Original Documents defining the constitution or legal status, place of registration and principal place of business of the bidder and JV partners; e) An affidavit that the Bidder has not been blacklisted pursuant to Sub-Clause 3.1(a)(iii)

4. f) An Affidavit that the Bidder has read and accepts NTDC's SOP for blacklisting of Contractors pursuant to Sub-Clause 3.1(a)(iii) & ITB 38 of Bid Data Sheet of this document. g) Proof of purchase of Bidding Documents from the Employer; h) Beneficial Ownership Declaration Performa dully filled by the Bidder as per S.R.O 592(I)/2022 available at <https://www.ppra.org.pk/doc/sro592.pdf>. i) PEC license pursuant to Sub-Clause 3.1a(i); and j)

7.	9.1	The qualification criteria to establish the supply / production capability of the bidder. <i>see Eligibility Criteria</i>
8.	11.2	Works and Their related documents: <i>See section Required Scope of Work</i>
9.	11.1	Price schedule will be provided according to the format defined and acquired. <i>see section price schedule.</i>
10.	11.4	Specifications: <i>see section of specifications.</i>
11.	11.5 & 13.5	The price shall be Fixed . The bid price shall be adjusted in accordance with Appendix provided - Formula for Price Adjustment.
12.	14.1	Currency of the Bids shall be : PKR
13.	16.1	The Bids/Bid Validity period shall be: 60 Days
14.	17.1	The amount of Bid Security shall be as defined in Bid Security Section for items and lots given in BDS 6
15.	17.2	The Bid Security shall be in the form of: Pay Order, Banker's Cheque, Call at Deposit, Bank Guarantee, Demand Draft
16.	15.1	Alternative Bids to the requirements of the bidding documents will not be permitted.

D. Submission of Bids

17.	18.1 & 21.1	<p>Bid shall be submitted online on EPADS v2.0 whereas hard copy of the bid security should be submitted to the following;</p> <p>House# 23- Nargis Block Allama Iqbal Town Lahore., Lahore City, Lahore (District), Lahore Division (Division), Punjab (Province).</p> <p>Bids that are not submitted on EPADS v2.0 shall be disqualified.</p> <p>The deadline for Bids submission is: Monday, May 18, 2026 11:00 AM</p>
------------	------------------------	---

E. Opening and Evaluation of Bids

18.	24.1	<p>The Bids opening shall take place on EPADS v2.0.</p> <p>Day : Monday</p> <p>Date: May 18, 2026</p> <p>Time : 11:30 AM</p>
19.	30.2	<p>Selection technique adopted will be: Least Cost Based Selection (LCBS)</p> <p><i>see Evaluation Criteria</i></p>

F. Award of Contract

20.	41.1 & 41.2	<p>The Performance guarantee shall: 10.00%.</p> <p>The Performance Guarantee shall be acceptable in the form of: Pay Order, Banker's Cheque, Call at Deposit, Bank Guarantee, Demand Draft</p>
------------	------------------------	--

21.	45.1	Arbitrator shall be appointed by mutual consent of the both parties.
G. Review of Procurement Decisions		
22.	37	Grievance against this procurement shall be submitted online on EPADS v2.0.



Eligibility Criteria

Bidder's Type	Required Registration
Individual / Individual Consultant	NADRA CITIZENSHIP (CNIC/NICOP)
Sole Proprietorship	FBR (NTN)
Partnership Firm	FBR (GSTN)
Company (Private Limited)	SECP
Company (Public Limited)	PEC
Company (Holding Company)	
Company (Limited by Guarantee)	
State Owned Enterprise (Private Limited)	
State Owned Enterprise (Public Limited)	

Evaluation Criteria

Least Cost Based Selection (LCBS)

Technical Marks	240
Passing Marks	144
Technical Evaluation Criteria	
Technical Evaluation Criteria (Quantitative)(Doc Required)	60
Technical Evaluation Criteria	

Technical Evaluation Criteria (Quantitative)(Doc Required)	60
Technical Evaluation Criteria	
Technical Evaluation Criteria (Quantitative)(Doc Required)	60
Technical Evaluation Criteria	
Technical Evaluation Criteria (Quantitative)(Doc Required)	60

Jobs/Lots

Jobs Without Lots :

Job	Delivery Schedule	Quantity	Bid Security
XEN-EHV-TLCLHR-01-2026	Address: House# 23- Nargis Block Allama Iqbal Town Lahore., Lahore City, Lahore (District), Lahore Division (Division), Punjab (Province). Schedule: 27 Days Quantity: 01	1	1450310

Related Services :

No

Work Specifications and Market Rates

Jobs Without Lots :

Job: XEN-EHV-TLCLHR-01-2026

Specifications / Requirements:

Sr. No	Ref. No.	Description	Unit	Qty	Rate		Amount
1	01-2026/01	Clearing Right of Way	Job	1	100000	(Rupees One Hundred Thousand only)	100,000
2	01-2026/02	Mobilization and Demobilization	Job	2	700000	(Rupees Seven Hundred Thousand only)	1,400,000
3	01-2026/03	Check Survey including pegging out and layout of tower locations, spotting / stalking of towers, Tower Spotting adjustment etc	Job	1	50000	(Rupees Fifty Thousand only)	50,000

Sr. No	Ref. No.	Description	Unit	Qty	Rate		Amount
4	01-2026/04	Reinforced concrete pile pier foundations (cast in situ installation) complete with supply of materials etc. using Sulphate Resisting Cement (SRC) conforming to ASTM C-150 including installation of tower grounding for all tower types: a) Reinforced concrete pile caps with chimney grade and stub setting as per tower type and drawing No. PDW/TC-956 Single Pile Per Footing	Nos	8	485173	(Rupees Four Hundred Eighty Five Thousand One Hundred and Seventy Three only)	3,881,384
5	01-2026/05	Reinforced concrete pile pier foundations (cast in situ installation) complete with supply of materials etc. using Sulphate Resisting Cement (SRC) conforming to ASTM C-150 including installation of tower grounding for all tower types: b) Reinforced concrete single pile per footing 1220 mm dia. as per drawing No. PDW/TC-956 Single Pile Per Footing i) Pile shaft upto depth of 20 m	Lin.Mtr	160	190747	(Rupees One Hundred Ninety Thousand Seven Hundred and Forty Seven only)	30,519,520

Sr. No	Ref. No.	Description	Unit	Qty	Rate		Amount
6	01-2026/06	Transport & install 220kV towers types 'EG' Make B+0+8 , including leg extensions, stubs etc as the case may be, in accordance with requirements of tender documents and complete in all respect along with accessories including U-bolts/V-shackles, aerial markers, number plates, danger signs, phase plates and anti-climbing devices along with barbed wire etc.	Per Tower	2	1250000	(Rupees One Million Two Hundred Fifty Thousand only)	2,500,000
7	01-2026/07	Welding of erected tower bolts and nuts after final inspection up to height of 8.0 m from top of foundation chimney as per specification.	Nos	2	120000	(Rupees One Hundred Twenty Thousand only)	240,000
8	01-2026/08	Dismantling of Existing 02 Nos. EA Type Towers Make B+0+8 complete in all respects and its transport to the designated NGC store and proper accountal	Nos	2	500000	(Rupees Five Hundred Thousand only)	1,000,000

Sr. No	Ref. No.	Description	Unit	Qty	Rate		Amount
9	01-2026/09	Transport & install ACSR"Rail" Conductor for Twin conductor configuration, polymer insulator installation alongwith complete hardware, accessories & dampers etc. complete in all respects as per specifications & approved drawings	Lumpsum	1	1750000	(Rupees One Million Seven Hundred Fifty Thousand only)	1,750,000
10	01-2026/10	Transport & Install OPGW/Sheild wire including installation of drop down lengths for joint boxes at the towers along with allied hardware material including hardware assemblies, joint boxes accessories, dampers etc complete in all respects as per specifications & approved drawings.	Lumpsum	1	150000	(Rupees One Hundred Fifty Thousand only)	150,000
11	01-2026/11	Testing & Commissioning of Transmission line	Lumpsum	1	50000	(Rupees Fifty Thousand only)	50,000

Sr. No	Ref. No.	Description	Unit	Qty	Rate		Amount
12	01-2026/12	Bitumen coating for footing of towers	Per Tower	2	17334	(Rupees Seventeen Thousand Three Hundred and Thirty Four only)	34,668
13	01-2026/13	PST @ 16%					6,668,092
						GRAND TOTAL:	Rs48,343,664.00

Scope of Work

The scope of Work is the "CONSTRUCTION AND COMPLETION OF CIVIL WORKS, ERECTION, STRINGING, TESTING & COMMISSIONING FOR CONVERSION OF TOWER NOS. 42 & 43 OF 220KV DOUBLE CIRCUIT TWIN BUNDLE T/LINE SHEIKHUPURA -RAVI CIRCUIT I & II FROM SUSPENSION TYPE TO TENSION TYPE"

Price Schedule

For Individual Jobs

#	Job Title	Quantity	Unit Price (PKR)	Total Price (PKR)	Delivery Location	Delivery Period / Year	Country of Origin
---	-----------	----------	------------------	-------------------	-------------------	------------------------	-------------------

1							
2							

For Lots

#	Lot Title	Total Lot Price (PKR)	Country of Origin
1	[Lot 1 Title]		

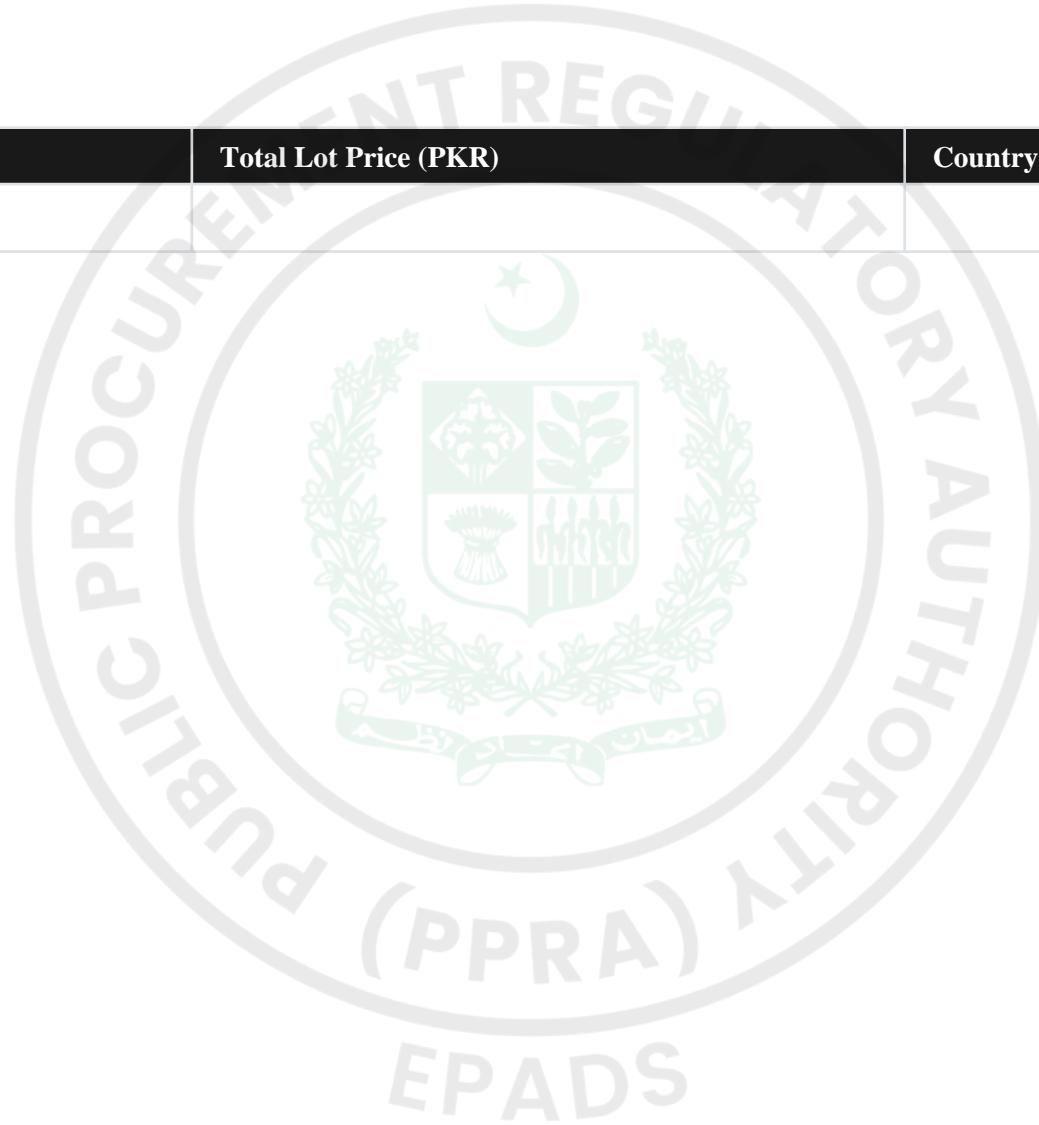





General Conditions of Contract

A. General

1. Definitions

1.1. Unless the context otherwise requires, the following terms whenever used in this Contract shall have the same meaning and shall be interpreted as indicated

1.1.1. "Applicable Law" means the laws and any other instruments having the force of law in the Government's Country, or in such other country as may be specified in the Special Conditions of the Contract (SC), as they may be issued and in force from time to time;

1.1.2. "The Contract" means an agreement enforceable by law;

1.1.3. "The Contract Price" means the price payable to the Contractor under the Contract for the full and proper performance of its contractual obligations;

1.1.4. "The Services" means the work to be performed by the Contractor pursuant to this Contract and as prescribed in the Specifications and Schedule of Activities included in the Contractor's Bid;

1.1.5. "Ancillary Services" means those services ancillary to the provision of Services, such as transportation and insurance, and any other incidental services, such as installation, commissioning, provision of technical assistance, training, and other such obligations of the Contractor covered under the Contract;

1.1.6. "GCC" means the General Conditions of Contract contained in this section;

1.1.7. "SCC" means the Special Conditions of Contract by which the GCC may be amended or supplemented;

1.1.8. "Day" means calendar day unless indicated otherwise;

1.1.9. "Effective Date" means the date on which this Contract comes into force and effect;

1.1.10. "The Contractor" means the individual or corporate body whose Bids to provide the Services has been accepted by the Procuring Agency;

1.1.11. "The Project Site," where applicable, means the place or places named in Bid Data Sheet and technical Specifications;

1.1.12. "Government" means the Government of Pakistan;

1.1.13. "Local Currency" means the currency of Pakistan;

1.1.14. "In Writing" means communicated in written form with proof of receipt;

1.1.15. "Completion Date" means the date of completion of the Services by the Contractor as certified by the Procuring Agency;

1.1.16. "Foreign Currency" means any currency other than the currency of the country of the Procuring Agency;

1.1.17. "Party" means the Procuring Agency or the Contractor, as the case may be, and "Parties" means both of them;

1.1.18. "Service" means any object of procurement other than goods or works;

1.1.19. "Subcontractor" means any entity to which the Bidder subcontracts any part of the Services.

2. **Applicable Law**

2.1. The contract shall be governed and interpreted in accordance with the laws of Pakistan, unless otherwise specified in SCC.

3. **Language**

3.1. The Contract as well as all correspondence and documents relating to the Contract exchanged between the Contractor and the Procuring Agency, shall be written in the **English language** unless otherwise stated in the SCC. Supporting documents and printed literature that are part of the Contract may be in another language provided these are accompanied by an accurate translation of the relevant passages in English, in which case, for purposes of interpretation of the Contract, this translation shall govern.

4. **Notices**

4.1. Any notice, request, or consent made pursuant to this Contract shall be in writing and shall be deemed to have been made when delivered in person to an authorized representative of the Party to whom the communication is addressed, or when sent by registered mail, telex, telegram, or facsimile to such Party at the address specified in the SCC.

5. **Location**

5.1. The Services shall be performed at such locations as the Procuring Agency may approve and as specified in SCC.

5.2. A {DOCUMENTS}

6. **Authorized Representatives / Authority of Member in charge**

6.1. Any action required or permitted to be taken, and any document required or permitted to be executed, under this Contract by the Procuring Agency or the Contractor may be taken or executed by the officials specified in the SCC.

B. **Commencement, Completion, Modification, and Termination of Contract**

1. **Effectiveness of Contract**

1.1. This Contract shall come into effect on the date the Contract is signed by both parties and such other later date as may be stated in the SCC.

2. Commencement of Services

2.1. The Contractor shall confirm availability of Key Experts and begin carrying out the Services not later than the number of days after the Effective Date specified in the SCC.

3. Program schedule

3.1. Before commencement of the Services, the Contractor shall submit to the Procuring Agency for approval a Program showing the general methods, arrangements, order and timing for all activities. The Services shall be carried out in accordance with the approved Program as updated.

4. Starting Date/Expiration Date

4.1. The Contractor shall start carrying out the Services Five (05) days after the date the Contract becomes effective, or at such other date as may be specified in the SCC.

4.2. Unless terminated earlier pursuant to Clause **GCC 14** hereof, this Contract shall expire at the end of such time period after the Effective Date as specified in the SCC.

5. Entire Agreement

5.1. This Contract contains all covenants, stipulations and provisions agreed by the Parties. No agent or representative of either Party has authority to make, and the Parties shall not be bound by or be liable for, any statement, representation, promise or agreement not set forth herein.

6. Modification

6.1. Any modification or variation of the terms and conditions of this Contract, including any modification or variation of the scope of the Services, may only be made by written agreement between the Parties. However, each Party shall give due consideration to any modification(s) or variation(s) made by the other Party.

6.2. In cases of any modification(s) or variation(s), the prior written consent of the Procuring Agency is required.

7. Force Majeure

7.1. Definition

For the purposes of this Contract, "Force Majeure" means an event which is beyond the reasonable control of a Contractor and which makes a Contractor's performance of its obligations under the Contract impossible or so impractical as to be considered impossible under the circumstances.

7.2. No Breach of Contract

The failure of a Party to fulfill any of its obligations under the contract shall not be considered to be a breach of, or default under, this Contract in so far as such inability arises from an event of Force Majeure, provided that the Party affected by such an event (a) has taken all reasonable precautions, due care and reasonable alternative

measures in order to carry out the terms and conditions of this Contract, and (b) has informed the other Party as soon as possible about the occurrence of such an event.

7.3. Extension of Time

Any period within which a Contractor shall, pursuant to this Contract, complete any action or task, shall be extended for a period equal to the time during which such Party was unable to perform such action as a result of Force Majeure.

7.4. Payments

During the period of their inability to perform the Services as a result of an event of Force Majeure, the Contractor shall be entitled to continue to be paid under the terms of this Contract, as well as to be reimbursed for additional costs reasonably and necessarily incurred by them during such period for the purposes of the Services and in reactivating the Service after the end of such period.

8. Termination

8.1. By the Procuring Agency

The Procuring Agency may terminate this Contract in case of the occurrence of any of the events specified in paragraphs (a) through (e) of this Clause. In such an occurrence the Procuring Agency shall give at least thirty (30) calendar days' written notice of termination to the Contractor in case of the events referred to in (a) through (d); at least sixty (60) calendar days' written notice in case of the event referred to in (e);

8.1.1. If the Contractor fails to remedy a failure in the performance of its obligations hereunder, as specified in a notice of suspension;

8.1.2. If the Contractor becomes (or, if the Contractor consists of more than one entity, if any of its members becomes) insolvent or bankrupt or enter into any agreements with their creditors for relief of debt or take advantage of any law for the benefit of debtors or go into liquidation or receivership whether compulsory or voluntary;

8.1.3. If the Contractor fails to comply with any final decision reached as a result of arbitration proceedings;

8.1.4. If, as the result of Force Majeure, the Contractor is unable to perform a material portion of the Services for a period of not less than sixty (60) calendar days;

8.1.5. If the Procuring Agency, in its sole discretion and for any reason whatsoever, decides to terminate this Contract;

8.2. By the Contractor

The Contractor may terminate this Contract, by not less than thirty (30) calendar days' written notice to the Procuring Agency, in case of the occurrence of any of the events specified in paragraphs (a) through (d) of this Clause.

8.2.1. If the Procuring Agency fails to pay any money due to the Contractor pursuant to this Contract and not subject to dispute within forty-five (45) calendar days after receiving written notice from the Contractor that such payment is overdue;

8.2.2. If, as the result of Force Majeure, the Contractor is unable to perform a material portion of the Services for a period of not less than sixty (60) calendar days;

8.2.3. If the Procuring Agency fails to comply with any final decision reached as a result of arbitration;

8.2.4. If the Procuring Agency is in material breach of its obligations pursuant to this Contract and has not remedied the same within forty-five (45) days (or such longer period as the Bidder may have subsequently approved in writing) following the receipt by the Procuring Agency of the Contractor's notice specifying such breach.

C. Obligations of the Contractor

1. General

1.1. Standard of Performance

1.1.1. The Contractor shall perform the Services and carry out the Services with all due diligence, efficiency and economy, in accordance with generally accepted professional standards and practices, and shall observe sound management practices, and employ appropriate technology and safe and effective equipment, machinery, materials and methods. The Contractor shall always act, in respect of any matter relating to this Contract or to the Services, as a faithful adviser to the Procuring Agency, and shall at all times support and safeguard the Procuring Agency's legitimate interests in any dealings with the third parties;

1.1.2. The Contractor shall employ and provide such qualified and experienced Experts and Sub-Contractors as are required to carry out the Services.

1.2. Law Applicable to Services

The Contractor shall perform the Services in accordance with the Contract and in accordance with the Law of Pakistan and shall take all practicable steps to ensure that any of its Experts and Sub-Bidders, comply with the Applicable Law.

2. Conflict of Interests

2.1. Contractor Not to Benefit from Commissions and Discounts

The remuneration of the Contractor shall constitute the Contractor's sole remuneration in connection with this Contract or the Services, and the Contractor shall not accept for their own benefit any trade commission, discount, or similar payment in connection with activities pursuant to this Contract or to the Services or in the discharge of their obligations under the Contract, and the Contractor shall use their best efforts to ensure that the Personnel, any Subcontractors, and agents of either of them similarly shall not receive any such additional remuneration.

2.2. Contractor and Affiliates Not to be Otherwise Interested in Project

The Contractor agree that, during the term of this Contract and after its termination, the Contractor and its affiliates, as well as any Subcontractor and any of its affiliates, shall be disqualified from providing Services (other than the Services and any continuation thereof) for any project resulting from or closely related to the Services.

2.3. Prohibition of Conflicting Activities

Neither the Bidder nor its Subcontractors nor the Personnel shall engage, either directly or indirectly, in any of the following activities:

- 2.3.1. during the term of this Contract, any business or professional activities in the Government's country which would conflict with the activities assigned to them under this Contract;
- 2.3.2. during the term of this Contract, neither the Contractor nor their Subcontractors shall hire public employees in active duty or on any type of leave, to perform any activity under this Contract;
- 2.3.3. after the termination of this Contract, such other activities as may be specified in the **SCC**.

3. Insurance to be Taken Out by the Contractor

3.1. The Contractor(a) shall take out and maintain, and shall cause any Subcontractors to take out and maintain, at its (or the Sub-contractors', as the case may be) own cost but on terms and conditions approved by the Procuring Agency, insurance against the risks, and for the coverage, as shall be specified in the **SCC**; and (b) at the Procuring Agency's request, shall provide evidence to the Procuring Agency showing that such insurance has been taken out and maintained and that the current premiums have been paid.

4. Contractor's Actions Requiring Procuring Agency's Prior Approval

4.1. The Contractor shall obtain the Procuring Agency's prior approval in writing before taking any of the following actions:

- 4.1.1. appointing such members of the Personnel not provided by the Contractor;
- 4.1.2. changing the Program of activities; and
- 4.1.3. any other action that may be specified in the **SCC**.

5. Reporting Obligations

5.1. The Contractor shall submit to the Procuring Agency the reports and documents in the numbers, and within the periods as prescribed by the Procuring Agency.

6. Liquidated Damages

6.1. Payments of Liquidated Damages

The Contractor shall pay liquidated damages to the Procuring Agency at the rate per day stated in the **SCC** for each day that the Completion Date is later than the Intended Completion Date. The total amount of liquidated damages shall not exceed the amount defined in the **SCC**. The Procuring Agency may deduct liquidated damages from payments due to the Contractor. Payment of liquidated damages shall not affect the Contractor's liabilities.

6.2. Correction for Over-payment

If the Intended Completion Date is extended after liquidated damages have been paid, the Procuring Agency shall correct any overpayment of liquidated damages by the Contractor by adjusting the next payment certificate. The

Contractor shall be paid interest on the overpayment, calculated from the date of payment to the date of repayment, at the rates specified in **SCC**.

6.3. Lack of performance penalty

If the Contractor has not corrected a Defect within the time specified in the Procuring Agency's notice, a penalty for Lack of performance will be paid by the Contractor. The amount to be paid will be calculated as a percentage of the cost of having the Defect corrected, assessed as specified in the Contractor

7. Performance Guarantee

7.1. Within the time stipulated in the acceptance letter from the Procuring Agency, the successful Bidder shall furnish the Performance Guarantee in shape and amount **specified in SCC**.

7.2. The proceeds of the Performance Guarantee shall be payable to the Procuring agency as compensation for any loss resulting from the Supplier's failure to complete its obligations under the Contract.

7.3. The Performance Guarantee shall be denominated in the currency of the Contract, or in a freely convertible currency acceptable to the Procuring agency and shall be in the acceptable form as specified in **SCC**.

7.4. The Performance Guarantee will be discharged by the Procuring agency and returned to the Supplier not later than thirty (30) days following the date of completion of the Supplier's performance obligations under the Contract, including any warranty obligations, unless otherwise **specified in SCC**.

8. Sustainable Procurement

8.1. The Contractor shall conform to the sustainable procurement contractual provisions, if and as specified in the **SCC**.

D. Contractor's Personnel

1. Description of Personnel

1.1. The titles, agreed job descriptions, minimum qualifications, and estimated periods of engagement in the carrying out of the Services of the Contractor's Key Personnel. The Key Personnel listed by title as well as by name are hereby approved by the Procuring Agency.

2. Removal and / or Replacement of Personnel

2.1. Except as the Procuring Agency may otherwise agree, no changes shall be made in the Key Personnel. If, for any reason beyond the reasonable control of the Contractor, it becomes necessary to replace any of the Key Personnel, the Contractor shall provide as a replacement a person of equivalent or better qualifications.

2.2. If the Procuring Agency finds that any of the Personnel have (i) committed serious misconduct or have been charged with having committed a criminal action, or (ii) have reasonable cause to be dissatisfied with the performance of any of the Personnel, then the Contractor shall, at the Procuring Agency's written request specifying the grounds thereof, provide as a replacement a person with qualifications and experience acceptable to the Procuring Agency.

2.3. The Contractor shall have no claim for additional costs arising out of or incidental to any removal and/or replacement of Personnel.

E. Obligations of the Procuring Agency

1. Change in the Applicable Law

1.1. If, after the date of this Contract, there is any change in the Applicable Law with respect to taxes and duties which increases or decreases the cost of the Services rendered by the Contractor, then the remuneration and reimbursable expenses otherwise payable to the Contractor under this Contract shall be increased or decreased accordingly by agreement between the Parties, and corresponding adjustments shall be made to the amounts referred in the SCC.

2. Services and Facilities

2.1. The Procuring Agency shall make available to the Contractor and the Experts, for the purposes of the Services and free of any charge, the services, facilities and property described in the Terms of Reference, at the times and in the manner specified in the Terms of Reference.

2.2. In case that such services, facilities and property shall not be made available to the Contractor, the Parties shall agree on (i) any time extension that it may be appropriate to grant to the Contractor for the performance of the Services, (ii) the manner in which the Contractor shall procure any such services, facilities and property from other sources, and (iii) the additional payments, if any, to be made to the Contractor as a result thereof.

F. Payments to the Contractor

1. Contract Price

1.1. The price payable shall be in Pakistani Rupees unless otherwise specified in the SCC.

2. Terms and Conditions of Payment

2.1. Payments will be made to the Contractor according to the payment schedule stated in the SCC and as per actual invoice submitted by the Contractor.

2.2. Unless otherwise stated in the SCC, the advance payment shall be made against the provision by the Contractor of a bank guarantee for the same amount, and shall be valid for the period stated in the SCC. Any other payment shall be made after the conditions listed in the SCC for such payment have been met, and the Contractor have submitted an invoice to the Procuring Agency specifying the amount due.

3. Quality Control Identifying Defects

3.1. The principle and modalities of Inspection of the Services by the Procuring Agency shall be as indicated in the SCC. The Procuring Agency shall check the Contractor's performance and notify him of any Defects that are

found. Such checking shall not affect the Contractor's responsibilities. The Procuring Agency may instruct the Contractor to search for a Defect and to uncover and test any service that the Procuring Agency considers may have a Defect. Defect Liability Period is as defined in the **SCC**.

3.2. A {INSPECTION}

4. Correction of Defects, and Lack of Performance Penalty

4.1. The Procuring Agency shall give notice to the contractor of any Defects before the end of the Contract. The Defects liability period shall be extended for as long as Defects remain to be corrected.

4.2. Every time notice a Defect is given; the contractor shall correct the notified Defect within the length of time specified by the Procuring Agency's notice.

4.3. If the contractor has not corrected a Defect within the time specified in the Procuring Agency's notice, the Procuring Agency will assess the cost of having the Defect corrected, the contractor will pay this amount, and a Penalty for Lack of Performance.

5. Settlement of Disputes Amicable Settlement

5.1. The Parties shall use their best efforts to settle amicably all disputes arising out of or in connection with this Contract or its interpretation.

6. Dispute Settlement

6.1. Arbitration

If any dispute of any kind whatsoever shall arise between the procuring agency and the contractor in connection with or arising out of the Contract, including without prejudice to the generality of the foregoing, any question regarding its existence, validity or termination, or the execution of the contract, the parties shall seek to resolve any such dispute or difference by mutual consultation. If the parties fail to resolve such a dispute or difference even after negotiations or mediation, then the dispute shall be referred within fourteen (14) days in writing by either party to the Arbitrator, with a copy to the other party.

Any dispute in respect of which a notice of intention to commence arbitration has been given, in accordance with **GCC sub-clause 32.1**, shall be finally settled by arbitration. Arbitration may be commenced prior to or after completion of the Contract. Arbitration proceedings shall be conducted in accordance with Arbitration Act 1940. Notwithstanding any reference to arbitration herein, the parties shall continue to perform their respective obligations under the Contract unless otherwise agreed. The Procuring Agency shall continue to pay the Contractor any undisputed amounts due under the Contract during the resolution of any dispute.



Special Conditions of Contract

SECTION VIII. SPECIAL CONDITIONS OF CONTRACT

The following Special Conditions of Contract shall supplement the General Conditions of Contract. Whenever there is a conflict, the provisions herein shall prevail over those in the Conditions of Contract. The corresponding clause number of the GCC is indicated in parentheses.

Number of GC Clause	Amendments of, and Supplements to, Clauses in the General Conditions of Contract
	<p>Definitions</p> <p>The Procuring Agency is:Executive Engineer TLC Division (EHV-I), NGC Lahore (National Grid Company (NGC)),Deputy ManagerHouse# 23- Nargis Block Allama Iqbal Town Lahore., Lahore City, Lahore (District), Lahore Division (Division), Punjab (Province).</p> <p>The Supplier is:</p> <p>The title of the subject procurement is:XEN-EHV-TLCLHR-01-2026: CONSTRUCTION AND COMPLETION OF CIVIL WORKS, ERECTION, STRINGING, TESTING & COMMISSIONING FOR CONVERSION OF TOWER NOS. 42 & 43 OF 220KV DOUBLE CIRCUIT TWIN BUNDLE T/LINE SHEIKHUPURA-RAVI CIRCUIT FROM SUSPENSION TO TENSION TYPE</p>
GCC 2	<p>Applicable/Governing Law:</p> <p>The Contract shall be interpreted in accordance with the laws of Islamic Republic of Pakistan</p>
GCC 3	<p>Language:</p> <p>The language of the Contract, all correspondence and communications to be given, and all other documentation to be prepared and supplied under the Contract shall be in English.</p>

<p>GCC 4</p>	<p>Notices:</p> <p>The addresses for the notices are:</p> <p>Procuring Agency:</p> <p>Executive Engineer TLC Division (EHV-I), NGC Lahore (National Grid Company (NGC)),Deputy Manager House# 23- Nargis Block Allama Iqbal Town Lahore., Lahore City, Lahore (District), Lahore Division (Division), Punjab (Province). +92-335-740-1928 ahmadumardewan@ntdc.com.pk</p> <p>Contractor/ Bidder:</p> <p>[Name, address and telephone number].</p> <p>The Contractor/ Bidder’s Representative(s)</p> <p>[Name, address, telephone number and e-mail address]</p>
<p>GCC 6.1</p>	<p>The Authorized Representatives are:</p> <p>For the Procuring Agency:</p> <p>Executive Engineer TLC Division (EHV-I), NGC Lahore (National Grid Company (NGC)),Deputy Manager House# 23- Nargis Block Allama Iqbal Town Lahore., Lahore City, Lahore (District), Lahore Division (Division), Punjab (Province). +92-335-740-1928 ahmadumardewan@ntdc.com.pk</p> <p>For the Bidder:</p> <p>Name:</p> <p>Designation:</p> <p>Address:</p>
<p>GCC 7</p>	<p>Effectiveness of the contract</p> <p>The Contractor/Bidder shall be effective within days from the date of signature of the Contract by both parties</p>

GCC 8	<p>Commencement of Contract:</p> <p>The Contractor/ Bidder shall provide Non-Consultancy Services from the effective date of contract.</p>
GCC 10.2	<p>Expiration of Contract:</p> <p>The time period shall be</p>
GCC 14	<p>Termination</p> <p>In the event of termination of the contract due to any reason as already defined in the General Conditions of Contract, the Bidder shall be responsible for providing to the Authority the Goods till the time of alternate arrangements.</p>
GCC 16	<p>Conflict of Interest:</p> <p>The Procuring Agency reserves the right to determine on a case-by-case basis whether the Bidder should be disqualified from providing goods or services due to a conflict of a nature described in Clause GCC 17.</p>
GCC 20	<p>Liquidated Damages</p> <p>If the Bidder fails to provide services as required under the contract or in case of any data loss/data breach or any incident compromising the data security or other such failures related to any services, the Bidder shall pay to the Procuring Agency as Liquidated Damages at a rate of 0.05% to 10.00% of the Contract value, in accordance with the extent of performance failure & the cost of investigating such incidents as judged by the Authority.</p>
GCC 21	<p>Performance Guarantee:</p> <p>The amount of performance guarantee shall be 10.00% of the contract price in acceptable form of Pay Order, Banker's Cheque, Call at Deposit, Bank Guarantee, Demand Draft</p>
GCC 27	<p>Currency of Payment:</p> <p>All the payment to be released to the contractor/Bidder shall be in Pakistani Rupees.</p>
GCC 28	<p>Payment terms:</p> <p>Payment will be made to the Bidder against the procured Goods and services according to the actual invoice or running bills submitted by the Bidder against the services provided within the time given in the conditions of the contract.</p>

GCC 29	<p>Identifying Defects:</p> <p>The Authority reserves the right at any time to inspect the premises of the provider to inspect the goods and monitor the goods being provided.</p> <p>Inspections & Tests Requirements</p> <p>For successful operation at site after complete installation, testing and commissioning of the Transmission line (Installation, Testing and Commissioning Report by Inspection Team/Procuring agency))</p> <p>Delivery & Documents</p> <p>Completion Certificate on completion of work</p> <p>Any other document mentioned in NGC Bidding Document No. XEN-EHV-TLCLHR-01-2026</p>

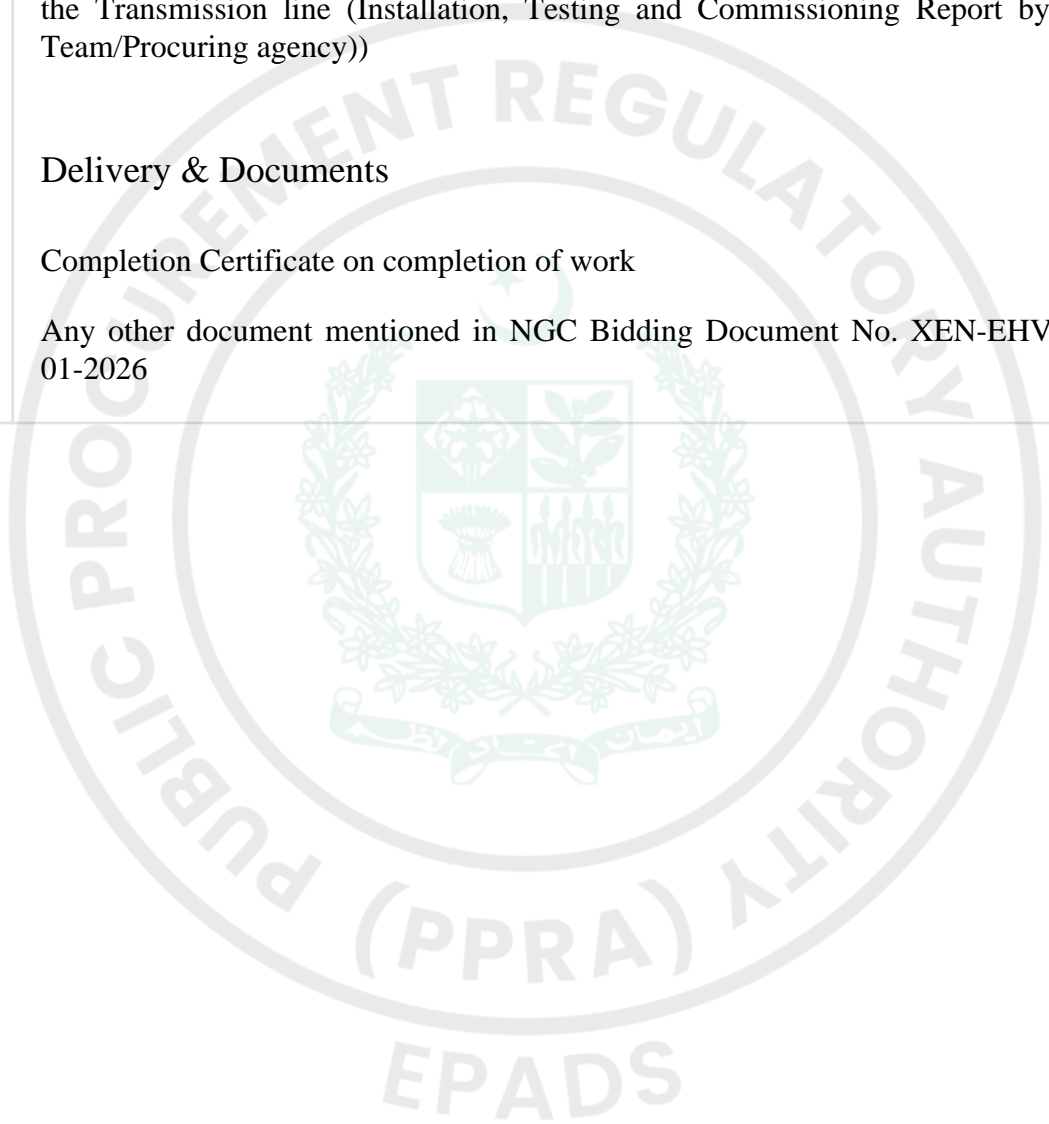

Following is the guidance for Dispute Resolution

1. If any dispute of any kind whatsoever shall arise between the Authority and the Bidder in connection with or arising out of the Contract, including without prejudice to the generality of foregoing, any question regarding its existence, validity, termination and the execution of the Contract – whether during developing phase or after their completion and whether before or after the termination, abandonment or breach of the Contract – the parties shall seek to resolve any such dispute or difference by mutual diligent negotiations in good faith within 14 (fourteen) days following a notice sent by one Party to the other Party in this regard.
2. At future of negotiation the dispute shall be resolved through mediation and mediator shall be appointed with the mutual consent of the both parties.
3. At the event of failure of mediation to resolve the dispute relating to this contract such dispute shall finally be resolved through binding Arbitration by sole arbitrator in accordance with Arbitration Act 1940. The arbitrator shall be appointed by mutual consent of the both parties. The Arbitration shall take place in Islamabad, Pakistan and proceedings will be conducted in English language.
4. The cost of the mediation and arbitration shall be shared by the parties in equal proportion however the both parties shall bear their own costs and lawyer's fees regarding their own participation in the mediation and arbitration. However, the Arbitrator may make an award of costs upon the conclusion of the arbitration making any party to the dispute liable to pay the costs of another party to the dispute.
5. Arbitration proceedings as mentioned in the above clause regarding resolution of disputes may be commenced prior to, during or after completion of the contract.

Notwithstanding any reference to the arbitration herein, the parties shall continue to perform their respective obligations under the Contract unless they otherwise agree that the Authority shall pay the Bidder any monies due to the Bidder.

Arbitrator's fee:

The fee shall be specified in Pak Rupees, as determined by the Arbitrator, which shall be shared equally by both parties.

Appointing Authority for Arbitrator:

By the Mutual Consent or in accordance with the provisions of Arbitration Act, 1940, in case the parties fail to reach a consensus on the name of sole arbitrator, any party may submit an application to the Chief Justice Islamabad High Court for appointment of sole arbitrator. The Chief Justice IHC may appoint a former judge of any High Court or Supreme Court as the sole arbitrator to resolve the dispute between the parties.

Rules of procedure for arbitration proceedings:

Any dispute between the Authority and a Bidder who is a national of the Islamic Republic of Pakistan arising in connection with the present Contract shall be referred to adjudication or arbitration in accordance with the laws of the Islamic Republic of Pakistan including Arbitration Act 1940, however above provision shall prevail in referring the case to the Arbitrator.

Place of Arbitration and Award:

The arbitration shall be conducted in English language and place of arbitration shall be at



Bid Securing Declaration

Form 9: Bid Securing Declaration

Date: *[insert date (as day, month and year)]*

Bid No.: **P24206**

To: **Executive Engineer TLC Division (EHV-I), NGC Lahore (National Grid Company (NGC)), Deputy Manager House# 23- Nargis Block Allama Iqbal Town Lahore., Lahore City, Lahore (District), Lahore Division (Division), Punjab (Province).**

We, the undersigned, declare that:

We understand that, according to your conditions, Bids must be supported by a Bid Securing Declaration.

We accept that we will be blacklisted and henceforth cross debarred for participating in respective category of public procurement proceedings for a period of (not more than) six months, if fail to abide with a bid securing declaration, however without indulging in corrupt and fraudulent practices, if we are in breach of our obligation(s) under the Bid conditions, because we:

1. have withdrawn or modified our Bid during the period of Bid Validity specified in the Form of Bid;
2. Disagreement to arithmetical correction made to the Bid price; or
3. having been notified of the acceptance of our Bid by the Procuring Agency during the period of Bid Validity, (i) failure to sign the contract if required by Procuring Agency to do so or (ii) fail or refuse to furnish the Performance Security or to comply with any other condition precedent to signing the contract specified in the Bidding Documents.

We understand this Bid Securing Declaration shall expire if we are not the successful

Bidder, upon the earlier of (i) our receipt of your notification to us of the name of the successful Bidder; or (ii) twenty-eight (28) days after the expiration of our Bid.



Contract Form

SECTION IX: CONTRACT FORMS

THIS AGREEMENT made the _____ day of _____ 20____ between **Executive Engineer TLC Division (EHV-I), NGC Lahore (National Grid Company (NGC)), Deputy Manager House# 23- Nargis Block Allama Iqbal Town Lahore., Lahore City, Lahore (District), Lahore Division (Division), Punjab (Province).**

(hereinafter called “the Procuring Agency”) of the one part and [name of Bidder] of [city and country of Bidder] (hereinafter called “the Bidder”) of the other part:

WHEREAS the Procuring Agency invited Bids for provision of goods, viz., **XEN-EHV-TLCLHR-01-2026: CONSTRUCTION AND COMPLETION OF CIVIL WORKS, ERECTION, STRINGING, TESTING & COMMISSIONING FOR CONVERSION OF TOWER NOS. 42 & 43 OF 220KV DOUBLE CIRCUIT TWIN BUNDLE T/LINE SHEIKHUPURA-RAVI CIRCUIT FROM SUSPENSION TO TENSION TYPE (P24206)** and has accepted a Bids by the Bidder for the provision of Goods in the sum of [contract price in words and figures] (hereinafter called “the Contract Price”).

NOW THIS CONTRACT WITNESSETH AS FOLLOWS:

1. In this Contract words and expressions shall have the same meanings as are respectively assigned to them in the Conditions of Contract referred to.

2. The following documents shall be deemed to form and be read and construed as part of this Contract, In the event of any ambiguity or conflict between the Contract Documents listed below, the order of precedence shall be the order in which the Contract Documents are listed below:-

1. This form of Contract;
2. the Form of Bids and the Price Schedule submitted by the Bidder;
3. the Schedule of Requirements;
4. the Technical Specifications;
5. the Special Conditions of Contract;
6. the General Conditions of the Contract;
7. the Procuring Agency’s Letter of Acceptance; and
8. [add here: any other documents]

3. In consideration of the payments to be made by the Procuring Agency to the Bidder as hereinafter mentioned, the Bidder hereby covenants with the Procuring Agency to provide the Goods related services and to remedy defects therein in conformity in all respects with the provisions of the Contract.

4. The Procuring Agency hereby covenants to pay the Bidder in consideration of the provision of Goods and the remedying of defects therein, the Contract Price or such other sum as may become payable under the provisions of the contract at the times and in the manner prescribed by the contract.

IN WITNESS whereof the parties hereto have caused this Contract to be executed in accordance with their respective laws the day and year first above written.

Signed, sealed, delivered by _____ the _____ (for the Procuring Agency)

Witness to the signatures of the Procuring Agency:

.....

Signed, sealed, delivered by _____ the _____ (for the Procuring Agency)

Witness to the signatures of the Bidder:





Integrity Pact

Integrity Pact

DECLARATION OF FEES, COMMISSION AND BROKERAGE ETC. PAYABLE BY THE SUPPLIERS OF GOODS, SERVICES & WORKS IN CONTRACTS WORTH RS.10.00 MILLION OR MORE

Contract Number: **Contract Value:** **Contract Title:**

Dated:

[Name of Supplier] hereby declares that it has not obtained or induced the procurement of any contract, right, interest, privilege or other obligation or benefit from Government of Pakistan or any administrative subdivision or agency thereof or any other entity owned or controlled by it (GoP) through any corrupt business practice.

Without limiting the generality of the foregoing [Name of Supplier] represents and warrants that it has fully declared the brokerage, commission, fee etc. paid or payable to anyone and not given or agreed to give and shall not give or agree to give to anyone within or outside Pakistan either directly or indirectly through any natural or juridical person, including its affiliate, agent, associate, broker, consultant, director, promoter, shareholder, sponsor or subsidiary, any commission, gratification, bribe, finder's fee or kickback, whether described as consultations fee or otherwise, with the object of obtaining or inducing the procurement of a contract, right, interest, privilege or other obligation or benefit in whatsoever form from GoP, except that which has been expressly declared pursuant hereto.

[Name of Supplier] certifies that it has made and will make full disclosure of all agreements and arrangements with all persons in respect of or related to the transaction with GoP and has not taken any action or will not take any action to circumvent the above declaration, representative or warranty.

[Name of Supplier] accepts full responsibility and strict liability for making and false declaration, not making full disclosure, misrepresenting fact or taking any action likely to defeat the purpose of this declaration, representation and warranty. It agrees that any contract, right interest, privilege or other obligation or benefit obtained or procured as aforesaid shall, without prejudice to any other right and remedies available to GoP under any law, contract or other instrument, be voidable at the option of GoP.

Notwithstanding any rights and remedies exercised by GoP in this regard, [Name of Supplier] agrees to indemnify GoP for any loss or damage incurred by it on account of its corrupt business practices and further pay compensation to GoP in an amount equivalent to ten times the sum of any commission, gratification, bribe, finder's fee or kickback given by [Name of Supplier] as aforesaid for the purpose of obtaining or inducing the procurement of any contract, right, interest, privilege or other obligation or benefit in whatsoever form from GoP.



Performance Guarantee Form

Performance Guarantee Form

To: **Executive Engineer TLC Division (EHV-I), NGC Lahore (National Grid Company (NGC)), Deputy Manager House# 23- Nargis Block Allama Iqbal Town Lahore., Lahore City, Lahore (District), Lahore Division (Division), Punjab (Province).**

WHEREAS *[name of Bidder]* (hereinafter called “the Bidder”) has undertaken, in pursuance of Contract No. *[reference number of the contract]* dated *[insert date]* for provision of Goods (hereinafter called “the Contract”).

AND WHEREAS it has been stipulated by you in the said Contract that the Bidder shall furnish you with a Bank Guarantee by a reputable bank for the sum specified therein as security for compliance with the Bidder’s performance obligations in accordance with the Contract.

AND WHEREAS we have agreed to give the Bidders guarantee:

THEREFORE, WE hereby affirm that we are Guarantors and responsible to you, on behalf of the Bidder, up to a total of *[amount of the guarantee in words and figures]*, and we undertake to pay you, upon your first written demand declaring the Bidder to be in default under the Contract and without cavil or argument, any sum or sums within the limits of *[amount of guarantee]* as aforesaid, without your needing to prove or to show grounds or reasons for your demand or the sum specified therein.

This guarantee is valid until the: *[insert date]*

Signature and seal of the Guarantors

[name of bank or financial institution]

[address]

[date]



Annexure

Complete Bidding Document No. XEN-EHV-TLCLHR-01-2026

This is a complete NGC Bidding document for the Tender No. XEN-EHV-TLCLHR-01-2026 and all prospective bidders shall follow the provisions stipulated in this documents

Information (Read-Only)

See Form Under Additional Forms and Documents: **Complete Bidding Document No. XEN-EHV-TLCLHR-01-2026** (page number: 78)





Procurement Forms

Past Experience and Completed Contracts

See Form Under Additional Forms and Documents: **Past Experience and Completed Contracts** (page number: 364)

Historical Contract Non-Performance, and Pending Litigation and Litigation History

See Form Under Additional Forms and Documents: **Historical Contract Non-Performance, and Pending Litigation and Litigation History** (page number: 365)

Current Contracts and Their Progress

See Form Under Additional Forms and Documents: **Current Contracts and Their Progress** (page number: 367)

Financial Capacity and Net Worth Evaluation Form

See Form Under Additional Forms and Documents: **Financial Capacity and Net Worth Evaluation Form** (page number: 368)

Average Annual Turnover

See Form Under Additional Forms and Documents: **Average Annual Turnover** (page number: 370)





Additional Forms and Documents

NATIONAL GRID COMPANY (NGC)
OF PAKISTAN LIMITED



BIDDING DOCUMENT NO. XEN-EHV-TLCLHR-01-2026

**CONSTRUCTION AND COMPLETION OF CIVIL WORKS, ERECTION,
STRINGING, TESTING & COMMISSIONING FOR CONVERSION OF TOWER
NOS. 42 & 43 OF 220KV DOUBLE CIRCUIT TWIN BUNDLE T/LINE
SHEIKHUPURA -RAVI CIRCUIT I & II FROM SUSPENSION TYPE TO
TENSION TYPE**

UNDER NGC'S OWN RESOURCES

SINGLE STAGE TWO ENVELOPE

**VOLUME-1
(Commercial & Technical Conditions)**

PREPARED BY:

EXECUTIVE ENGINEER (EHV-I) T/L'C' DIVISION NGC LAHORE

APRIL, 2026

Bidding Document No. XEN-EHV-TLCLHR-01-2026

This Bidding Document comprises of:

- 1) Volume-1: Commercial & Technical Conditions (1 Book)
- 2) Volume-II: Drawings (Soft Form)

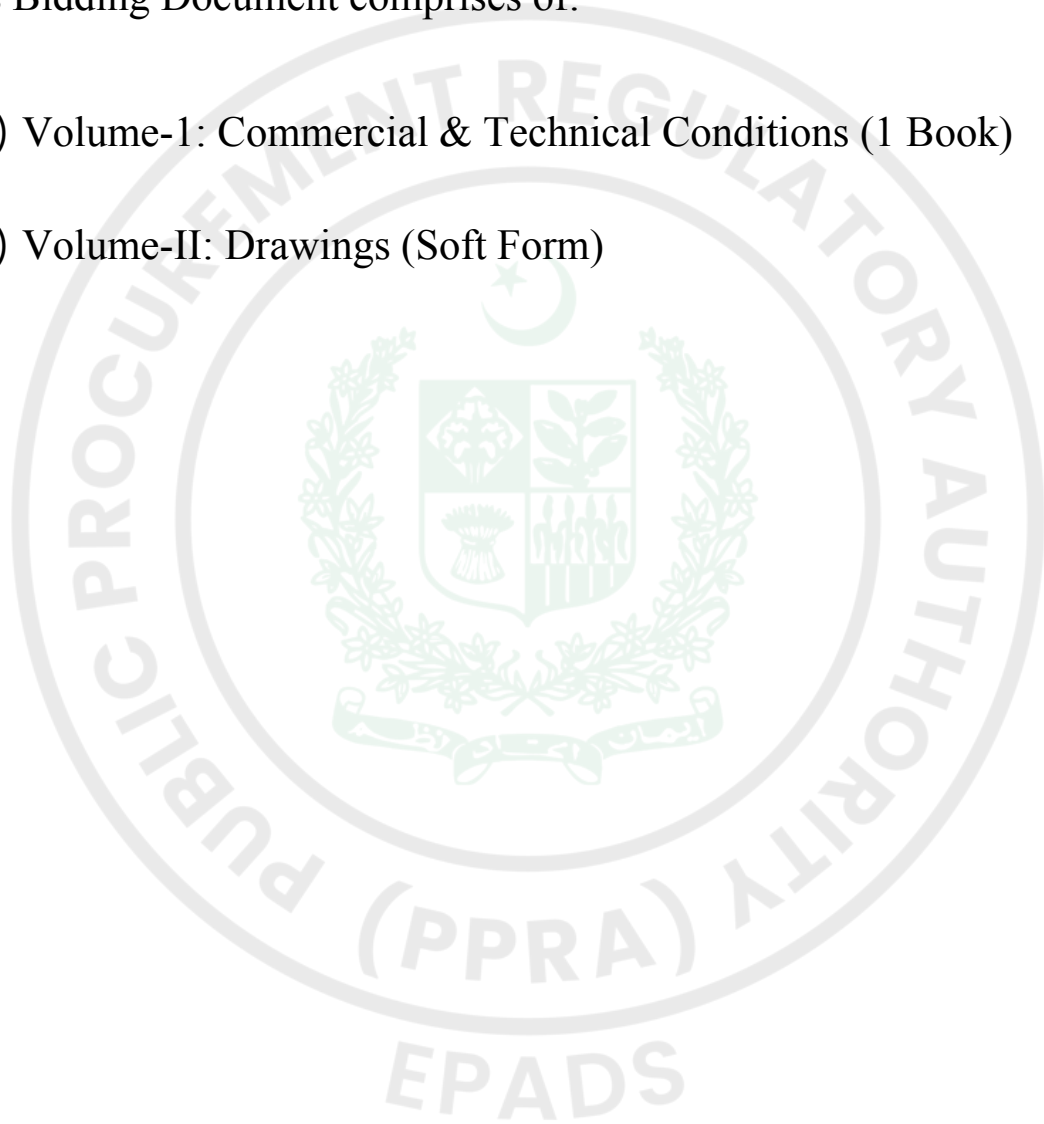

SUMMARY OF CONTENTS

Section No.	Description	Page No.
	Invitation For Bids	IFB 1
I	Instructions To Bidders	IB 1-12
II	Bid Data Sheet	BDS 1-28
III	Forms of Bid & Appendices To Bid	A 1-56
IV	General Conditions of Contract	GCC-1 & FIDIC (1-92)
V	Special Conditions of Contract	SCC 1-18
VI	Specifications - Special Provisions	SP 1-12
VII	Specifications - Technical Provisions	TP 1-44
	SOP for Blacklisting of Contractors	1-13

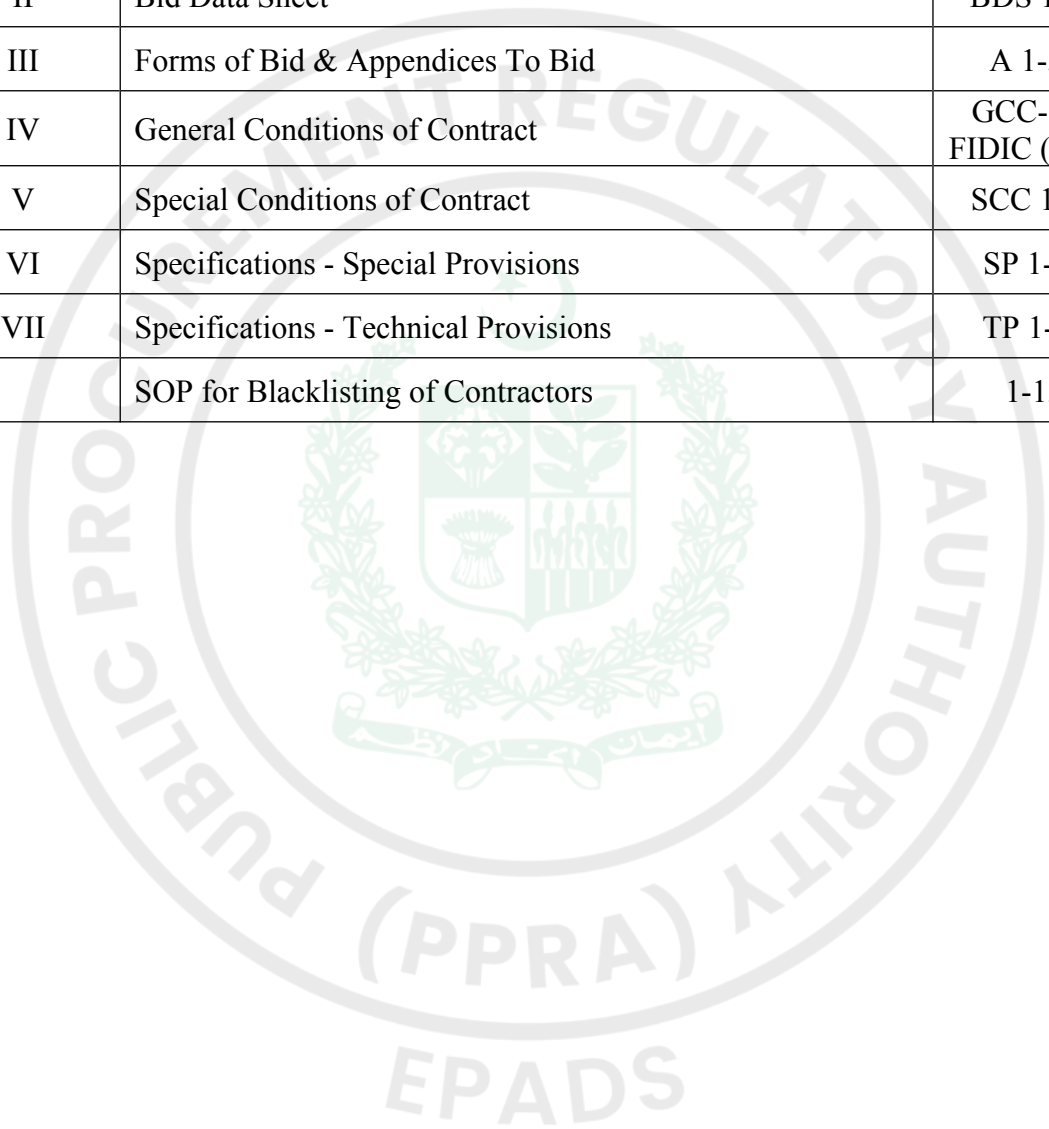



Invitation for Bids

INVITATION FOR BIDS

Date: 22/04/2026

Bid Reference No: XEN-EHV-TLCLHR-01-2026

1. National Grid Company (NGC) of Pakistan Limited “the Employer”, intends to get the Works done for **Contract No. XEN-EHV-TLCLHR-01-2026** through NGC’s own resources. The Scope of Works includes Construction and Completion of Civil Works, Erection, Stringing, Testing & Commissioning for conversion of Tower Nos. 42 & 43 of 220kV Double Circuit Twin Bundle T/line Sheikhpura -Ravi Circuit I & II from Suspension Type to Tension Type.
2. The Employer invites sealed bids from eligible firms or persons licensed by the Pakistan Engineering Council in the appropriate category for the above scope of Works. National Competitive Bidding (NCB) will be conducted in accordance with PEC’s Single Stage-Two Envelope (SSTE) procedure.
3. Bidders may obtain further information from, inspect at and acquire the Bidding Documents from the office of the Employer, at:

Executive Engineer (EHV-I) T/L’C’ Division NGC,
23-Nargis Block Allama Iqbal Town, Lahore-Pakistan.
Telephone No. 92-42-35472672
E-mail address: xenehv1tlcdivisionntdclahore@gmail.com
4. A complete set of Bidding Documents may be purchased by an interested Bidder on submission of a written application to the above office upon payment of a non-refundable fee of 5,000/- Rupees up to 14.05.2026 during working hours. The method of payment will be by bank draft from any scheduled bank of Pakistan in favor Project Director (EHV) NTDC, Lahore for XEN-EHV-TLCLHR-01-2026.
5. This invitation for bids is open to all bidders meeting the eligibility requirement as per bidding documents;
6. The bidder intending to participate in the bidding process must fulfill the criteria as specified in the bidding documents.
7. The bids must be received by the Employer through e-PADS before the bid submission deadline.
8. The bids must be submitted through **e-PADS only** on or before **18.05.2026** at 11:00 Hrs, however, Bid Security is required to be submitted in Original (hard copy) before bids closing deadline, at the address mentioned at Sr. No. 3. Technical bids will be opened at 11:30 Hrs on the same day, in the presence of Bidder’s representatives who choose to attend at the same address.
9. All bidders must fill in check list before submission of bid in their own interest as per section G of Instructions to Bidders which is a mandatory requirement.
10. NGC reserves all its rights regarding rejection of bids as defined in Clause 33(1) of PPRA Rules 2004.

**Executive Engineer (EHV-I)
T/L’C’ Division NGC Lahore**



NATIONAL GRID COMPANY OF PAKISTAN LIMITED (NGC)

EXECUTIVE ENGINEER (EHV-I)
T/L'C' DIVISION NGC LAHORE

No. 856-55 /XEN/EHV-I/TLCLHR/WG-265

Dated 22/04/2026

Director (M&PR) NGC,
G-63, WAPDA House,
Lahore.

Subject:- **TENDER NO. XEN-EHV-TLCLHR-01-2026:**
CONSTRUCTION AND COMPLETION OF CIVIL WORKS, ERECTION,
STRINGING, TESTING & COMMISSIONING FOR CONVERSION OF TOWER
NOS. 42 & 43 OF 220KV DOUBLE CIRCUIT TWIN BUNDLE T/LINE
SHEIKHUPURA -RAVI CIRCUIT I & II FROM SUSPENSION TYPE TO TENSION
TYPE
PUBLICATION OF INVITATION FOR BIDS

Enclosed please find herewith tender notice for invitation of bids through E-PAK Acquisition and Disposal System (E-PADS) from interested bidders against the subject Tender for publication of the same in leading newspapers as well as on PPRA and NGC websites.

Necessary funds are available for publication. Furthermore, PPRA advance payment amounting to PKR.15,000/- (Rupees Fifteen Thousand Only) in favor of PPRA Islamabad against account No. 04540013100701 for early publication/uploading on website has already been paid inline with the PPRA Notification No. 5(4)/PPRA/Fin-Status-Rec/2023-24 dated 09.08.2024 (copy enclosed).



Executive Engineer (EHV-I)
T/L'C' Division NGC, Lahore

Copy to:

1. Chief Engineer (EHV-I) NGC, NTDC House, Lahore.
2. Director (I.T) NGC, Wapda House, Lahore with the request to upload the above tender notice on NTDC/NGC website, please.
3. Project Director (EHV-I) NGC, Lahore.
4. Dy. Manager Corporate Accounts (EHV-I) NGC, Lahore.
5. Asstt. Manager Corporate Accounts (EHV-I) NGC, Lahore.
Master file/relevant file

INVITATION FOR BIDS**Date: 22/04/2026****Bid Reference No: XEN-EHV-TLCLHR-01-2026**

1. National Grid Company (NGC) of Pakistan Limited "the Employer", intends to get the Works done for **Contract No. XEN-EHV-TLCLHR-01-2026** through NGC's own resources. The Scope of Works includes Construction and Completion of Civil Works, Erection, Stringing, Testing & Commissioning for Conversion of Tower Nos. 42 & 43 of 220kV Double Circuit Twin Bundle T/line Sheikhpura -Ravi Circuit I & II from Suspension Type to Tension Type.
2. The Employer invites sealed bids from eligible firms or persons licensed by the Pakistan Engineering Council in the appropriate category for the above scope of Works. National Competitive Bidding (NCB) will be conducted in accordance with PEC's Single Stage-Two Envelope (SSTE) procedure.
3. Bidders may obtain further information from, inspect at and acquire the Bidding Documents from the office of the Employer, at:
 Executive Engineer (EHV-I) T/L'C' Division NGC,
 23-Nargis Block Allama Iqbal Town, Lahore-Pakistan.
 Telephone No. 92-42-35472672
 E-mail address: xenehv1tlcdivisionntdclahore@gmail.com
4. A complete set of Bidding Documents may be purchased by an interested Bidder on submission of a written application to the above office upon payment of a non-refundable fee of 5,000/- Rupees up to 14.05.2026 during working hours. The method of payment will be by bank draft from any scheduled bank of Pakistan in favor Project Director (EHV) NTDC, Lahore for XEN-EHV-TLCLHR-01-2026.
5. This invitation for bids is open to all bidders meeting the eligibility requirement as per bidding documents;
6. The bidder intending to participate in the bidding process must fulfill the criteria as specified in the bidding documents.
7. The bids must be received by the Employer through e-PADS before the bid submission deadline.
8. The bids must be submitted through **e-PADS only** on or before **18.05.2026** at 11:00 Hrs, however, Bid Security is required to be submitted in Original (hard copy) before bids closing deadline, at the address mentioned at Sr. No. 3. Technical bids will be opened at 11:30 Hrs on the same day, in the presence of Bidder's representatives who choose to attend at the same address.
9. All bidders must fill in check list before submission of bid in their own interest as per section G of Instructions to Bidders which is a mandatory requirement.
10. NGC reserves all its rights regarding rejection of bids as defined in Clause 33(1) of PPRA Rules 2004.

Executive Engineer (EHV-I)
T/L'C' Division NGC Lahore

SECTION I**INSTRUCTIONS TO BIDDERS**

(Note: These Instructions to Bidders along with Bidding Data will not be part of the Contract and will cease to have effect once the Contract is signed.)

A. GENERAL**IB.1 Scope of Bid**

- 1.1 The Employer as defined in the Bidding Data hereinafter called “the Employer” wishes to receive bids for the construction and completion of works as described in these Bidding Documents, and summarized in the Bidding Data hereinafter referred to as the “Works”.
- 1.2 The successful bidder will be expected to complete the Works within the time specified in Appendix-A to Bid.

IB.2 Source of Funds

- 2.1 The Employer has applied for/received a loan/credit from the source (s) indicated in the Bidding Data in various currencies towards the cost of the project specified in the Bidding Data and it is intended that part of the proceeds of this loan/credit will be applied to eligible payments under the Contract for which these Bidding Documents are issued.

IB.3 Eligible Bidders

- 3.1 This Invitation for Bids is open to all bidders meeting the following requirements:
 - a. Duly licensed by the Pakistan Engineering Council (PEC) in the category relevant to the value of the Works.
 - b. Duly prequalified/ enlisted with the Employer.

IB.4 One Bid per Bidder

- 4.1 Each bidder shall submit only one bid either by himself, or as a partner in a joint venture. A bidder who submits or participates in more than one bid (other than alternatives pursuant to Clause IB.16) will be disqualified.

IB.5 Cost of Bidding

- 5.1 The bidders shall bear all costs associated with the preparation and submission of their bids and the Employer will in no case be responsible or liable for those costs, regardless of the conduct or outcome of the bidding process.

IB.6 Site Visit

- 6.1 The bidders are advised to visit and examine the Site of Works and its surroundings and obtain for themselves on their own responsibility all information that may be necessary for preparing the bid and entering into a contract for construction of the Works. All cost in this respect shall be at the bidder’s own expense.

- 6.2 The bidders and any of their personnel or agents will be granted permission by the Employer to enter upon his premises and lands for the purpose of such inspection, but only upon the express condition that the bidders, their personnel and agents, will release and indemnify the Employer, his personnel and agents from and against all liability in respect thereof and will be responsible for death or personal injury, loss of or damage to property and any other loss, damage, costs and expenses incurred as a result of such inspection.

B. BIDDING DOCUMENTS

IB.7 Contents of Bidding Documents

- 7.1 The Bidding Documents, in addition to invitation for bids, are those stated below and should be read in conjunction with any Addenda issued in accordance with Clause IB.9.
1. Instructions to Bidders.
 2. Bidding Data.
 3. General Conditions of Contract, Part-I (GCC).
 4. Particular Conditions of Contract, Part-II (PCC).
 5. Specifications – Special Provisions.
 6. Specifications - Technical Provisions.
 7. Form of Bid & Appendices to Bid.
 8. Bill of Quantities
 9. Form of Bid Security.
 10. Form of Contract Agreement.
 11. Forms of Performance Security and Mobilization Advance Guarantee/Bond.
 12. Drawings.
- 7.2 The bidders are expected to examine carefully the contents of all the above documents. Failure to comply with the requirements of bid submission will be at the Bidder's own risk. Pursuant to Clause IB.26, bids which are not substantially responsive to the requirements of the Bidding Documents will be rejected.

IB.8 Clarification of Bidding Documents

- 8.1 Any prospective bidder requiring any clarification (s) in respect of the Bidding Documents may notify the Employer in writing at the Employer's address indicated in the Invitation for Bids. The Employer will respond to any request for clarification which he receives earlier than 28 days prior to the deadline for submission of bids.

Copies of the Employer's response will be forwarded to all purchasers of the Bidding Documents, including a description of the enquiry but without identifying its source.

IB.9 Amendment of Bidding Documents

- 9.1 At any time prior to the deadline for submission of bids, the Employer may, for any reason, whether at his own initiative or in response to a clarification requested by a prospective bidder, modify the Bidding Documents by issuing addendum.
- 9.2 Any addendum thus issued shall be part of the Bidding Documents pursuant to Sub-Clause 7.1 hereof and shall be communicated in writing to all purchasers of the Bidding Documents. Prospective bidders shall acknowledge receipt of each addendum in writing to the Employer.

- 9.3 To afford prospective bidders reasonable time in which to take an addendum into account in preparing their bids, the Employer may extend the deadline for submission of bids in accordance with Clause IB.20

C. PREPARATION OF BIDS

IB.10 Language of Bid

- 10.1 The bid and all correspondence and documents related to the bid exchanged by a bidder and the Employer shall be in the bid language stipulated in the Bidding Data and Particular Conditions of Contract. Supporting documents and printed literature furnished by the bidders may be in any other language provided the same are accompanied by an accurate translation of the relevant parts in the bid language, in which case, for purposes of evaluation of the bid, the translation in bid language shall prevail.

IB.11 Documents Accompanying the Bid

- 11.1 Each bidder shall:

- (a) submit a written Power of Attorney authorizing the signatory of the bid to act for and on behalf of the bidder;
- (b) update the information indicated and listed in the Bidding Data and previously submitted with the application for prequalification, and continue to meet the minimum criteria set out in the prequalification documents which as a minimum, would include the following:
 - (i) Evidence of access to financial resources along with average annual construction turnover;
 - (ii) Financial predictions for the current year and the two following years including the effect of known commitments;
 - (iii) Work commitments since prequalification;
 - (iv) Current litigation information; and
 - (v) Availability of critical equipment.

and

- (c) furnish a technical proposal taking into account the various Appendices to Bid specially the following:

Appendix-E to Bid	Proposed Construction Schedule
Appendix-F to Bid	Method of Performing the Work
Appendix-G to Bid	List of Major Equipment
Appendix-M to Bid	Organization Chart for Supervisory Staff

 and other pertinent information such as mobilization programme etc.;

- 11.2 Bids submitted by a joint venture of two (2) or more firms shall comply with the following requirements:

- (a) The bid and in case of a successful bid, the Form of Contract Agreement shall be signed so as to be legally binding on all partners;
- (b) One of the joint venture partners shall be nominated as being in charge; and this authorization shall be evidenced by submitting a power of attorney signed by legally authorized signatories of all the joint venture partners;

- (c) The partner-in-charge shall always be duly authorized to deal with the Employer regarding all matters related with and/or incidental to the execution of Works as per the terms and Conditions of Contract and in this regard to incur any and all liabilities, receive instructions, give binding undertakings and receive payments on behalf of the joint venture;
- (d) All partners of the joint venture shall at all times and under all circumstances be liable jointly and severally for the execution of the Contract in accordance with the Contract terms and a statement to this effect shall be included in the authorization mentioned under Sub-Para(b) above as well as in the Form of Bid and in the Form of Contract Agreement (in case of a successful bid); and
- (e) A copy of the agreement entered into by the joint venture partners shall be submitted with the bid stating the conditions under which it will function, its period of duration, the persons authorized to represent and obligate it and which persons will be directly responsible for due performance of the Contract and can give valid receipts on behalf of the joint venture, the proportionate participation of the several firms forming the joint venture, and any other information necessary to permit a full appraisal of its functioning. No amendments / modifications whatsoever in the joint venture agreement shall be agreed to between the joint venture partners without prior written consent of the Employer.

11.3 Bidders shall also submit proposals of work methods and schedule, in sufficient detail to demonstrate the adequacy of the Bidders' proposals to meet the technical specifications and the completion time referred to in Sub-Clause 1.2 hereof.

IB.12 Bid Prices

- 12.1 Unless stated otherwise in the Bidding Documents, the Contract shall be for the whole of the Works as described in Sub-Clause 1.1 hereof, based on the unit rates and / or prices submitted by the bidder.
- 12.2 The bidders shall fill in rates and prices for all items of the Works described in the Bill of Quantities. Items against which no rate or price is entered by a bidder will not be paid for by the Employer when executed and shall be deemed covered by rates and prices for other items in the Bill of Quantities.
- 12.3 All duties, taxes and other levies payable by the Contractor under the Contract, or for any other cause, as on the date 28 days prior to the deadline for submission of bids shall be included in the rates and prices and the total Bid Price submitted by a bidder.

Additional / reduced duties, taxes and levies due to subsequent additions or changes in legislation shall be reimbursed / deducted as per Sub-Clause 70.2 of the General Conditions of Contract Part-I.

- 12.4 The rates and prices quoted by the bidders are subject to adjustment during the performance of the Contract in accordance with the provisions of Clause 70 of the Conditions of Contract. The bidders shall furnish the prescribed information for the price adjustment formulae in Appendix-C to Bid, and shall submit with their bids such other supporting information as required under the said Clause.

IB.13 Currencies of Bid and Payment

- 13.1 The unit rates and the prices shall be quoted by the bidder entirely in Pak rupees. A bidder expecting to incur expenditures in other currencies for inputs to the Works supplied from outside the Employer's country (referred to as the "Foreign

Currency Requirements”) shall indicate the same in Appendix-B to Bid. The proportion of the Bid Price (excluding Provisional Sums) needed by him for the payment of such Foreign Currency Requirements either (i) entirely in the currency of the Bidder’s home country or, (ii) at the bidder’s option, entirely in Pak rupees provided always that a bidder expecting to incur expenditures in a currency or currencies other than those stated in (i) and (ii) above for a portion of the foreign currency requirements, and wishing to be paid accordingly, shall indicate the respective portions in his bid.

- 13.2 The rates of exchange to be used by the bidder for currency conversion shall be the TT&OD Selling Rates published or authorized by the State Bank of Pakistan prevailing on the date 28 days prior to the deadline for submission of bids.

For the purpose of payments, the exchange rates used in bid preparation shall apply for the duration of the Contract.

IB.14 Bid Validity

- 14.1 Bids shall remain valid for the period stipulated in the Bidding Data after the Date of Bid Opening specified in Clause IB.23.
- 14.2 In exceptional circumstances, prior to expiry of the original bid validity period, the Employer may request that the bidders extend the period of validity for a specified additional period which shall in no case be more than the original bid validity period. The request and the responses thereto shall be made in writing. A bidder may refuse the request without forfeiting his Bid Security. A bidder agreeing to the request will not be required or permitted to modify his bid, but will be required to extend the validity of his Bid Security for the period of the extension, and in compliance with Clause IB.15 in all respects.

IB.15 Bid Security

- 15.1 Each bidder shall furnish, as part of his bid, a Bid Security in the amount stipulated in the Bidding Data in Pak Rupees or an equivalent amount in a freely convertible currency.
- 15.2 The Bid Security shall be, at the option of the bidder, in the form of Deposit at Call or a Bank Guarantee issued by a Scheduled Bank in Pakistan or from a foreign bank duly counter guaranteed by a Scheduled Bank in Pakistan in favor of the Employer valid for a period 28 days beyond the Bid Validity date.
- 15.3 Any bid not accompanied by an acceptable Bid Security shall be rejected by the Employer as non-responsive.
- 15.4 The bid securities of unsuccessful bidders will be returned as promptly as possible, but not later than 28 days after the expiration of the period of Bid Validity.
- 15.5 The Bid Security of the successful bidder will be returned when the bidder has furnished the required Performance Security and signed the Contract Agreement.
- 15.6 The Bid Security may be forfeited:
- (a) if the bidder withdraws his bid except as provided in Sub-Clause 22.1;

- (b) if the bidder does not accept the correction of his Bid Price pursuant to Sub-Clause 27.2 hereof; or
- (c) if the bidder is involved in Corrupt and/or fraudulent practices.
- (d) In case of successful bidder, if he fails within the specified time limit to:
 - (i) furnish the required Performance Security; or
 - (ii) sign the Contract Agreement.

IB.16 Alternate Proposals by Bidder

- 16.1 Should any bidder consider that he can offer any advantages to the Employer by a modification to the designs, specifications or other conditions, he may, in addition to his bid to be submitted in strict compliance with the Bidding Documents, submit any Alternate Proposal(s) containing (a) relevant design calculations; (b) technical specifications; (c) proposed construction methodology; and (d) any other relevant details / conditions, provided always that the total sum entered on the Form of Bid shall be that which represents complete compliance with the Bidding Documents.
- 16.2 Alternate Proposal(s), if any, of the lowest evaluated responsive bidder only may be considered by the Employer as the basis for the award of Contract to such bidder.

IB.17 Pre-Bid Meeting

- 17.1 The Employer may, on his own motion or at the request of any prospective bidder(s), hold a pre-bid meeting to clarify issues and to answer any questions on matters related to the Bidding Documents. The date, time and venue of pre-bid meeting, if convened, is as stipulated in the Bidding Data. All prospective bidders or their authorized representatives shall be invited to attend such a pre-bid meeting.
- 17.2 The bidders are requested to submit questions, if any, in writing so as to reach the Employer not later than seven (7) days before the proposed pre-bid meeting.
- 17.3 Minutes of the pre-bid meeting, including the text of the questions raised and the replies given, will be transmitted without delay to all purchasers of the Bidding Documents. Any modification of the Bidding Documents listed in Sub-Clause 7.1 hereof which may become necessary as a result of the pre-bid meeting shall be made by the Employer exclusively through the issue of an Addendum pursuant to Clause IB.9 and not through the minutes of the pre-bid meeting.
- 17.4 Absence at the pre-bid meeting will not be a cause for disqualification of a bidder.

IB.18 Format and Signing of Bid

- 18.1 Bidders are particularly directed that the amount entered on the Form of Bid shall be for performing the Contract strictly in accordance with the Bidding Documents.
- 18.2 All appendices to Bid are to be properly completed and signed.

- 18.3 No alteration is to be made in the Form of Bid nor in the Appendices thereto except in filling up the blanks as directed. If any such alterations be made or if these instructions be not fully complied with, the bid may be rejected.
- 18.4 Each bidder shall prepare by filling out the forms completely and without alterations one (1) original and number of copies, specified in the Bidding Data, of the documents comprising the bid as described in Clause IB.7 and clearly mark them “ORIGINAL” and ‘COPY” as appropriate. In the event of discrepancy between them, the original shall prevail.
- 18.5 The original and all copies of the bid shall be typed or written in indelible ink (in the case of copies, Photostats are also acceptable) and shall be signed by a person or persons duly authorized to sign on behalf of the bidder pursuant to Sub- Clause 11.1(a) hereof. All pages of the bid shall be initialed and stamped by the person or persons signing the bid.
- 18.6 The bid shall contain no alterations, omissions or additions, except to comply with instructions issued by the Employer, or as are necessary to correct errors made by the bidder, in which case such corrections shall be initialed by the person or persons signing the bid.
- 18.7 Bidders shall indicate in the space provided in the Form of Bid their full and proper addresses at which notices may be legally served on them and to which all correspondence in connection with their bids and the Contract is to be sent.
- 18.8 Bidders should retain a copy of the Bidding Documents as their file copy.

D. SUBMISSION OF BIDS

IB.19 Sealing and Marking of Bids

- 19.1 Each bidder shall submit his bid as under:
- (a) ORIGINAL and each copy of the Bid shall be separately sealed and put in separate envelopes and marked as such.
 - (b) The envelopes containing the ORIGINAL and copies will be put in one sealed envelope and addressed / identified as given in Sub- Clause 19.2 hereof.
- 19.2 The inner and outer envelopes shall:
- (a) be addressed to the Employer at the address provided in the Bidding Data;
 - (b) bear the name and identification number of the contract as defined in the Bidding Data; and
 - (c) provide a warning not to open before the time and date for bid opening, as specified in the Bidding Data.
- 19.3 In addition to the identification required in Sub-Clause 19.2 hereof, the inner envelope shall indicate the name and address of the bidder to enable the bid to be returned unopened in case it is declared “late” pursuant to Clause IB.21

- 19.4 If the outer envelope is not sealed and marked as above, the Employer will assume no responsibility for the misplacement or premature opening of the Bid.

IB.20 Deadline for Submission of Bids

- 20.1 (a) Bids must be received by the Employer at the address specified no later than the time and date stipulated in the Bidding Data.
- (b) Bids with charges payable will not be accepted, nor will arrangements be undertaken to collect the bids from any delivery point other than that specified above. Bidders shall bear all expenses incurred in the preparation and delivery of bids. No claims will be entertained for refund of such expenses.
- (c) Where delivery of a bid is by mail and the bidder wishes to receive an acknowledgment of receipt of such bid, he shall make a request for such acknowledgment in a separate letter attached to but not included in the sealed bid package.
- (d) Upon request, acknowledgment of receipt of bids will be provided to those making delivery in person or by messenger.
- 20.2 The Employer may, at his discretion, extend the deadline for submission of bids by issuing an amendment in accordance with Clause IB.9, in which case all rights and obligations of the Employer and the bidders previously subject to the original deadline will thereafter be subject to the deadline as extended.

IB.21 Late Bids

- 21.1 (a) Any bid received by the Employer after the deadline for submission of bids prescribed in Clause IB.20 will be returned unopened to such bidder.
- (b) Delays in the mail, delays of person in transit, or delivery of a bid to the wrong office shall not be accepted as an excuse for failure to deliver a bid at the proper place and time. It shall be the bidder's responsibility to determine the manner in which timely delivery of his bid will be accomplished either in person, by messenger or by mail.

IB.22 Modification, Substitution and Withdrawal of Bids

- 22.1 Any bidder may modify, substitute or withdraw his bid after bid submission provided that the modification, substitution or written notice of withdrawal is received by the Employer prior to the deadline for submission of bids.
- 22.2 The modification, substitution, or notice for withdrawal of any bid shall be prepared, sealed, marked and delivered in accordance with the provisions of Clause IB.19 with the outer and inner envelopes additionally marked "MODIFICATION", "SUBSTITUTION" or "WITHDRAWAL" as appropriate.
- 22.3 No bid may be modified by a bidder after the deadline for submission of bids except in accordance with Sub-Clauses 22.1 and 27.2.

- 22.4 Withdrawal of a bid during the interval between the deadline for submission of bids and the expiration of the period of bid validity specified in the Form of Bid may result in forfeiture of the Bid Security in pursuance to Clause IB.15.

E. BID OPENING AND EVALUATION

IB.23 Bid Opening

- 23.1 The Employer will open the bids, including withdrawals, substitution and modifications made pursuant to Clause IB.22, in the presence of bidders' representatives who choose to attend, at the time, date and location stipulated in the Bidding Data. The bidders' representatives who are present shall sign a register evidencing their attendance.
- 23.2 Envelopes marked "MODIFICATION", "SUBSTITUTION" or "WITHDRAWAL" shall be opened and read out first. Bids for which an acceptable notice of withdrawal has been submitted pursuant to Clause IB.22 shall not be opened.
- 23.3 The bidder's name, total Bid Price and price of any Alternate Proposal(s), any discounts, bid modifications, substitution and withdrawals, the presence or absence of Bid Security, and such other details as the Employer may consider appropriate, will be announced by the Employer at the opening of bids.
- 23.4 Employer shall prepare minutes of the bid opening, including the information disclosed to those present in accordance with the Sub-Clause 23.3.

IB.24 Process to be Confidential

- 24.1 Information relating to the examination, clarification, evaluation and comparison of bid and recommendations for the award of a contract shall not be disclosed to bidders or any other person not officially concerned with such process before the announcement of bid evaluation report which shall be done at least ten (10) days prior to issue of Letter of Acceptance. The announcement to all Bidders will include table(s) comprising read out prices, discounted prices, price adjustments made, final evaluated prices and recommendations against all the bids evaluated. Any effort by a bidder to influence the Employer's processing of bids or award decisions may result in the rejection of such bidder's bid. Whereas any bidder feeling aggrieved may lodge a written complaint not later than fifteen (15) days after the announcement of the bid evaluation report; however mere fact of lodging a complaint shall not warrant suspension of the procurement process.

IB.25 Clarification of Bids

- 25.1 To assist in the examination, evaluation and comparison of bids, the Employer may, at his discretion, ask any bidder for clarification of his bid, including breakdowns of unit rates. The request for clarification and the response shall be in writing but no change in the price or substance of the bid shall be sought, offered or permitted except as required to confirm the correction of arithmetic errors discovered by the Employer in the evaluation of the bids in accordance with Clause IB.28.

IB.26 Examination of Bids and Determination of Responsiveness

- 26.1 Prior to the detailed evaluation of bids, the Employer will determine whether each bid is substantially responsive to the requirements of the Bidding Documents.
- 26.2 A substantially responsive bid is one which (i) meets the eligibility criteria; (ii) has been properly signed; (iii) is accompanied by the required Bid Security; and (iv) conforms to all the terms, conditions and specifications of the Bidding Documents, without material deviation or reservation. A material deviation or reservation is one (i) which affect in any substantial way the scope, quality or performance of the Works; (ii) which limits in any substantial way, inconsistent with the Bidding Documents, the Employer's rights or the bidder's obligations under the Contract; or (iii) adoption/rectification whereof would affect unfairly the competitive position of other bidders presenting substantially responsive bids.
- 26.3 If a bid is not substantially responsive, it will be rejected by the Employer, and may not subsequently be made responsive by correction or withdrawal of the non-conforming deviation or reservation.

IB.27 Correction of Errors

- 27.1 Bids determined to be substantially responsive will be checked by the Employer for any arithmetic errors. Errors will be corrected by the Employer as follows:
- (a) Where there is a discrepancy between the amounts in figures and in words, the amount in words will govern; and
 - (b) Where there is a discrepancy between the unit rate and the line-item total resulting from multiplying the unit rate by the quantity, the unit rate as quoted will govern, unless in the opinion of the Employer there is an obviously gross misplacement of the decimal point in the unit rate, in which case the line item total as quoted will govern and the unit rate will be corrected.
- 27.2 The amount stated in the Form of Bid will be adjusted by the Employer in accordance with the above procedure for the correction of errors and with the concurrence of the bidder, shall be considered as binding upon the bidder. If the bidder does not accept the corrected Bid Price, his Bid will be rejected, and the Bid Security shall be forfeited in accordance with Sub- Clause 15.6(b) hereof.

IB.28 Evaluation and Comparison of Bids

- 28.1 The Employer will evaluate and compare only the Bids determined to be substantially responsive in accordance with Clause IB.26.
- 28.2 In evaluating the Bids, the Employer will determine for each Bid the evaluated Bid Price by adjusting the Bid Price as follows:
- (a) making any correction for errors pursuant to Clause IB.27;
 - (b) excluding Provisional Sums and the provision, if any, for contingencies in the Summary Bill of Quantities, but including competitively priced Day-work; and
 - (c) making an appropriate adjustment for any other acceptable variation or deviation.

- 28.3 The estimated effect of the price adjustment provisions of the Conditions of Contract, applied over the period of execution of the Contract, shall not be taken into account in Bid evaluation.
- 28.4 If the Bid of the successful bidder is seriously unbalanced in relation to the Employer's estimate of the cost of work to be performed under the Contract, the Employer may require the bidder to produce detailed price analyses for any or all items of the Bill of Quantities to demonstrate the internal consistency of those prices with the construction methods and schedule proposed. After evaluation of the price analyses, the Employer may require that the amount of the Performance Security set forth in Clause IB.32 be increased at the expense of the successful bidder to a level sufficient to protect the Employer against financial loss in the event of default of the successful bidder under the Contract.

F. AWARD OF CONTRACT

IB.29 Award

- 29.1 Subject to Clauses IB.30 and IB.34, the Employer will award the Contract to the bidder whose bid has been determined to be substantially responsive to the Bidding Documents and who has offered the lowest evaluated Bid Price, provided that such bidder has been determined to be eligible in accordance with the provisions of Clause IB.3 and qualify pursuant to Sub-Clause IB 29.2.
- 29.2 The Employer, at any stage of the bid evaluation, having credible reasons for or *prima facie* evidence of any defect in supplier's or contractor's capacities, may require the suppliers or contractors to provide information concerning their professional, technical, financial, legal or managerial competence whether already pre-qualified or not:

Provided that such qualification shall only be laid down after recording reasons therefor in writing. They shall form part of the records of that bid evaluation report.

IB.30 Employer's Right to Accept any Bid and to Reject any or all Bids

- 30.1 Notwithstanding Clause IB.29, the Employer reserves the right to accept or reject any Bid, and to annul the bidding process and reject all bids, at any time prior to award of Contract, without thereby incurring any liability to the affected bidders or any obligation except that the grounds for rejection of all bids shall upon request be communicated to any bidder who submitted a bid, without justification of grounds. Rejection of all bids shall be notified to all bidders promptly.

IB.31 Notification of Award

- 31.1 Prior to expiration of the period of bid validity prescribed by the Employer, the Employer will notify the successful bidder in writing ("Letter of Acceptance") that his Bid has been accepted. This letter shall name the sum which the Employer will pay the Contractor in consideration of the execution and completion of the Works by the Contractor as prescribed by the Contract (hereinafter and in the Conditions of Contract called the "Contract Price").
- 31.2 No Negotiation with the bidder having evaluated as lowest responsive or any other bidder shall be permitted, however, Employer may have clarification meetings to get clarify any item in the bid evaluation report.

- 31.3 The notification of award and its acceptance by the bidder will constitute the formation of the Contract, binding the Employer and the bidder till signing of the formal Contract Agreement.
- 31.4 Upon furnishing by the successful bidder of a Performance Security, the Employer will promptly notify the other bidders that their Bids have been unsuccessful and return their bid securities.

IB.32 Performance Security

- 32.1 The successful bidder shall furnish to the Employer a Performance Security in the form and the amount stipulated in the Bidding Data and the Conditions of Contract within a period of 28 days after the receipt of Letter of Acceptance.
- 32.2 Failure of the successful bidder to comply with the requirements of Sub-Clause IB.32.1 or Clauses IB.33 or IB.35 shall constitute sufficient grounds for the annulment of the award and forfeiture of the Bid Security.

IB.33 Signing of Contract Agreement

- 33.1 Within 14 days from the date of furnishing of acceptable Performance Security under the Conditions of Contract, the Employer will send the successful bidder the Contract Agreement in the form provided in the Bidding Documents, incorporating all agreements between the parties.
- 33.2 The formal Agreement between the Employer and the successful bidder shall be executed within 14 days of the receipt of the Contract Agreement by the successful bidder from the Employer.

IB.34 General Performance of the Bidders

The Employer reserves the right to obtain information regarding performance of the bidders on their previously awarded contracts/works. The Employer may in case of consistent poor performance of any Bidder as reported by the employers of the previously awarded contracts, inter alia, reject his bid and/or refer the case to the Pakistan Engineering Council (PEC). Upon such reference, PEC in accordance with its rules, procedures and relevant laws of the land take such action as may be deemed appropriate under the circumstances of the case including black listing of such Bidder and debarring him from participation in future bidding for similar works.

IB.35 Integrity Pact

The Bidder shall sign and stamp the Integrity Pact provided at Appendix-O to Bid in the Bidding Documents for all Federal Government procurement contracts exceeding Rupees ten million. Failure to provide such Integrity Pact shall make the bidder non-responsive.

IB.36 Instructions not Part of Contract

Bids shall be prepared and submitted in accordance with these Instructions which are provided to assist bidders in preparing their bids, and do not constitute part of the Bid or the Contract Documents.

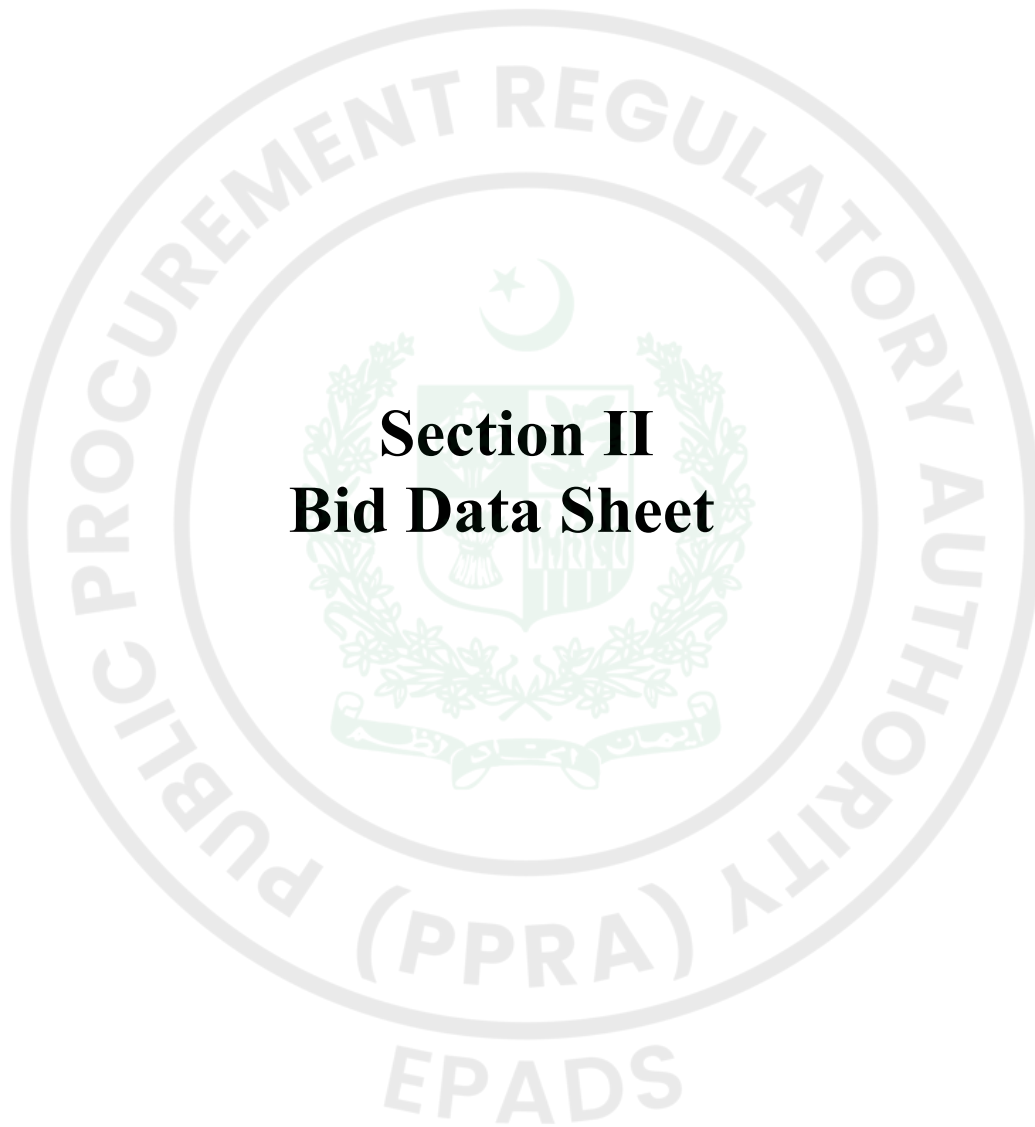

Section II

Bid Data Sheet

BID DATA SHEET

The following specific data for the Works to be bided shall complement, amend, or supplement the provisions in the Instructions to Bidders. Wherever there is a conflict, the provisions herein shall prevail over those in the Instructions to Bidders.

IB 1.1	<p>Name and address of the Employer:</p> <p>Name: Project Director (EHV-I) NGC Address: NTDC House, 34-Industrial Area Gulberg-III, Lahore-Pakistan. Telephone No. 92-42-99263225; Fax No. +92-42-99263226 E-mail address: pdehvlhr@ntdc.com.pk</p>
IB 1.1	The bidding is open to National Competitive Bidding (NCB).
IB 1.1	<p>The name of the Tender is:</p> <p>Construction and Completion of Civil Works, Erection, Stringing, Testing & Commissioning for Conversion of Tower Nos. 42 & 43 of 220kV Double Circuit Twin Bundle T/line Sheikhpura -Ravi Circuit I & II from Suspension Type to Tension Type</p> <p>The identification number of the Tender is: XEN-EHV-TLCLHR-01-2026.</p>
IB 2.1	Source of Funding: NGC's own Resources.
IB 3.1 (a)	<p>The existing sub clause 3.1(a) is deleted and replaced with following:</p> <p>The Invitation for Bids is open to all bidders in their sole capacity or as joint venture meeting the following requirements:</p> <ul style="list-style-type: none"> i) The Bidder shall be duly licensed by the Pakistan Engineering Council (PEC) minimum in the category C-4 or had applied for renewal of license before submission of its bid. In case of Joint Venture, all the partners shall be duly licensed by PEC and the sum total of the limit of construction cost permitted by the categories of the individual licensees shall not be less than limit of construction cost permitted by the category required here above. ii) Contractor shall be on Active Taxpayers List of the Federal Board of Revenue and relevant Provincial Revenue Authority. iii) The Bidder shall not be blacklisted by NGC(NTDC)/WAPDA/DISCOs/any Government/Public department/Donor Agencies at the time of submission of bids. The Bidder should provide details of previous black listing, if any. An affidavit is to be provided by the Bidder that the Bidder is not black listed by NGC(NTDC)/WAPDA/DISCOs/any Government/Public department/Donor Agencies at the time of submission of bids. Further, the bidder shall submit an undertaking along with his bid that he has read and accepts the provisions of

	<p>NGC(NTDC) Policy for Blacklisting of Contractors (copy of policy attached with the bidding documents). Non-submission of this undertaking may result in the rejection of the bid. The undertaking will subsequently become part of the Contract Agreement as well.</p> <p>iv) The bidder shall submit dully filled/complete Beneficial Ownership Declaration Performa as per S.R.O 592(I)/2022 available at https://www.ppra.org.pk/doc/sro592.pdf</p>
<p>IB 3.1(b)</p>	<p>Delete IB 3.1(b) and replace it with the following.</p> <p>Qualification of the Bidder</p> <p>To be qualified for award of a contract, the Bidder shall meet the qualification criteria delineated herein below:</p> <p>1. Construction Experience:</p> <ul style="list-style-type: none"> • The bidder as a main contractor (as single entity or as JV partner* or approved subcontractor) must have substantially completed construction contract(s) comprising of detailed survey, sub-soil investigations, construction of tower conventional foundations, erection of towers, stringing, testing & commissioning of <i>220 kV or higher voltage</i> transmission lines of at least 5 km (cumulative) strung by controlled tension method during last ten (10) years. <p>*If the Bidder has executed these contract(s) as a JV partner, he shall have carried out all the activities mentioned here before.</p> <p>* For purpose of this clause, the experience shall be evidenced through Completion Certificates/Taking over Certificates etc. showing substantial completion of works.</p> <ul style="list-style-type: none"> • Such transmission lines must have been operating successfully prior to deadline for submission of bids. • In case the bid is submitted by a joint venture under this bidding process, lead partners shall meet the above experience criteria. • Each JV partner other than the lead partner must have completed as a main contractor, JV partner or approved sub-contractor construction contract(s) comprising of detailed survey, sub-soil investigations, construction of conventional foundations, erection of towers, stringing, testing & commissioning of 220 kV or higher bundled voltage transmission line of at least 1 km strung by controlled tension method during last ten (10) years. • The Bidder shall submit with the Bid evidence in this regard including inter alia copies (with English translation) of the contract agreement(s) and substantial completion certificate(s),

and Defects Liability Certificates (where applicable), for the contract(s).

- The bidder shall have his own tension stringing equipment along with associated T&P and critical equipment duly supported with documentary evidence/ catalogues/ drawings for undertaking such like works in good working condition. Alternatively, if not so, the bidder will identify the confirmed source of the said machinery, T&P etc. along with documentary evidence/ catalogues/ drawings and shall provide necessary guarantee/surety that he will arrange the said equipment in good working condition through its own resources prior to start of stringing activity. The aforementioned documentary evidence shall be submitted with the bid.

2. Key Personnel:

The Bidder shall have the personnel for the key positions to be deployed for meeting the following requirements (Information to be submitted in Appendix-G to Bid given in Section-III of the Bidding Documents):

Positions	Relevant Construction Experience	No. of Personnel
Project Manager	10	01
Electrical Engineer(s)	07	01
Civil Engineer(s)	07	02

The above personnel shall be graduate (minimum 16 years education) engineers or equivalent.

** Note: The rejection of key personnel shall not result in rejection of the bid, however, bidder shall undertake to replace the key personnel with the acceptable to the Employer in case of award of contract.*

3. Bidder's Financial Capability:

The Employer will take into account the following criteria to verify the financial qualification of the Bidder.

- The audited Financial "Standalone" Statements (Balance Sheet along with Notes, Profit & Loss Accounts and Cash Flow Statement) audited by Chartered Accountant for the last five (05) years shall be submitted by the Bidder. The Bidder's Financial Statements for the last one year of the audited accounts should show that it has positive "NET WORTH" calculated as a difference between total assets and total liabilities (Information to be submitted in prescribed Form QF-5 of Appendix-N to Bid given in Section-III of the Bidding Documents). In case of JV,

each JV partner shall meet the aforementioned criteria.

- (ii) Minimum average annual turnover of **PKR 50 Million** calculated as best of three years total certified payments received for contracts in progress or completed, within the last 05 years. The average annual turnover may include turnover of affiliates and subsidiaries to the extent of shareholding percentage of the Bidding company provided the turnover is accrued from similar business activity as the Bidding company.
(Information to be submitted in prescribed Form QF-6 of Appendix-N to Bid given in Section-III of the Bidding Documents.)
In case of JV, all the JV partners shall combinedly meet the requisite criteria with the lead partner and other partner(s) meeting not less than 40% and 25% respectively of the said criteria.
- (iii) The Bidder must demonstrate access to, or availability of, financial resources such as liquid assets, lines of credit (issued specifically for the project), and other financial means to meet the total cash flow demands of this contract which is being considered equal to **20 Million PKR plus 25% of the Bidder's commitments for running contracts** (Information to be submitted in prescribed Form QF-7 of Appendix-P to Bid given in Section-III of the Bidding Documents).

Notes:

- In case of JV, all the JV partners shall combinedly meet the requisite criteria with the lead partner and other partner(s) meeting not less than 40% and 25% respectively of the said criteria.
- The Bidder shall provide his current work commitments in form QF-4 of Appendix-P to Bid given in Section-III of the Bidding Documents.
- The bidder shall provide bank certificate for his lines of credit on the prescribed Form QF-8 of Appendix-P to Bid given in Section-III of the Bidding Documents.
- Credit Lines submitted after opening of bids shall not be acceptable. Any withdrawal of the credit lines from the bidder's creditors during validity of bid shall be considered a withdrawal of bid.
- The bidder shall provide bank certificate for his lines of credit on the prescribed Form QF-8 of Appendix-P to Bid given in Section-III of the Bidding Documents.

In case of more than one Lot(s), Bidder is determined to be lowest evaluated substantially responsive in more than one Lot(s), qualification of the Bidder shall be assessed to meet the aggregate requirements for

	<p>award of multiple Lots. [If, in this instant, the bidder qualifies for multiple Lots, Purchaser will have right to open price bids for all lots and consider most economical offer/bid/combination at its discretion].</p> <p>4. Bidder's Litigation History</p> <p>Bidders are required to submit details of all litigation, arbitration and other claims whether pending, threatened or resolved in the last five years. The Employer may disqualify bidder in the event that the total amount of pending or threatened litigation, arbitration or other claims represents fifty percent (50%) of the Bidder's net worth. Details in this regard should be submitted in the prescribed Form QF-9 given in Appendix-P of Section-III of Bidding Document.</p> <p>Construction Experience of subsidiaries or parent/sister/affiliate companies shall not be considered for qualification of the Bidder.</p> <p>The Qualification of the Bidders will be based on meeting the pass/ fail criteria as demonstrated by the Bidders' responses in the respective Appendices.</p> <p>The above stated requirements are the minimum and the Employer reserves the right to request for any additional information. The Employer also reserves the right to reject the proposal of any Bidder, if in the opinion of the Employer the qualification details are incomplete, ambiguous or the Bidder is found not qualified to satisfactorily perform the Contract.</p> <p>The above stated Appendices should be completed as per prescribed format and submitted along with required attachments. The missing or incomplete information/ documents may render the bid substantially non-responsive. In this regard, the Employer does not have an obligation to request any document/ certificates.</p>
IB 3.2	<p>The following sub clause is added after 3.1:</p> <p>A Bidder shall not have a conflict of interest. All Bidders found to have a conflict of interest shall be disqualified. A Bidder may be considered to be in a conflict of interest with one or more parties in this bidding process if, including but not limited to:</p> <ul style="list-style-type: none"> (i) They have controlling shareholders in common; or (ii) They receive or have received any direct or indirect subsidy from any of them; or (iii) They have the same legal representative for purposes of this bid; or (iv) They have a relationship with each other, directly or through common third parties, that puts them in a position to have access to material information about or improperly influence the bid of another Bidder, or influence the decisions of the Employer regarding this bidding process; or

	<p>(v) A Bidder or any affiliated entity, participated as a consultant in the preparation of the design or technical specifications of the plant and services that are the subject of the bid.</p> <p>(vi) A Bidder was affiliated with a firm or entity that has been hired (or is proposed to be hired) by the Employer or Employer's country as Engineer for the Contract; or</p> <p>(vii) A Bidder would be providing goods, works, or non consulting services resulting from or directly related to consulting services for the preparation or implementation of the project specified in the IB 19.2(b) that it provided, or were provided by any affiliate that directly or indirectly controls, is controlled by, or is under common control with that firm; or</p> <p>(viii) A Bidder that has a financial or familial relationship with Employer's personnel including personnel of project implementing/executing agency who: (i) are directly or indirectly involved in the preparation of the bidding documents or specifications of the Contract, and/or the bid evaluation process of such Contract; or (ii) would be involved in the implementation or supervision of such Contract unless the conflict stemming from such relationship has been resolved in a manner acceptable to the Employer throughout the procurement process and execution of the contract.</p>
IB 6.1	<p>The Bidder shall inspect the site, examine and obtain all information required and satisfy himself regarding matters and things such as access to site, communication, transport, right of way, the type and number of equipment and facilities required for the satisfactory completion of work, the quantity of various sections of the work, the availability of local labor, availability and rates of materials, local working conditions, uncertainties of weather, obstructions and hindrances that may arise etc., which may affect the work or cost thereof, before submission of his bid. Ignorance of site conditions shall not be accepted by the Employer as basis for any claim for compensation. The submission of a bid by the bidder will be construed as evidence that such an examination was made and any later claims/disputes in regard to rates quoted shall not be entertained or considered by the Employer.</p>
IB 7.2	<p>The Bidders should ensure that they have received the Bidding Documents including Addenda (if any) complete in all respects. The Employer accepts no responsibility for any Bidder lacking a complete set of Bidding Documents including Addenda (if any). The complete Bidding Document including Addenda (if any) will also be available on Employer's website i.e. www.ntdc.com.pk and through e-PADS.</p>

IB 8.1	<p>The Sub-Clause 8.1 is amended to the following extent:</p> <p>No request for clarification will be entertained which will be received later than 14 days prior to the date fixed for submission of Bids. The Purchaser’s response will be made not later than 7 days prior to the date fixed for submission of Bids.</p> <p>Moreover, the bidders may also submit their request for clarification through e-PADS.</p> <p>Further, the mere request for clarification from the bidders shall not be a ground for seeking extension in the deadline for submission of Bids.</p>																																							
IB 10.1	<p>The bid with all accompanying documents and all communications in relation to or concerning the bidding Process shall be in English language and strictly on the forms provided in the bidding Documents. In case any of these Documents is in another language, it must be accompanied by an accurate translation of the relevant passages in English, in which case, for all purposes of interpretation of the bid, the translation in English shall prevail. Any portions of Bids that are not in English may not be evaluated. Failure to comply with this may disqualify a bid.</p>																																							
IB 11.1	<p>Documents Comprising the Bid</p> <p>Delete the text of this Sub-Clause and substitute with the following:</p> <p>The Bidder shall submit the bid through e-PADS only in 2 separate pdf files, one to be referred as “Technical Bid” and the other to be referred as “Price Bid” comprising the following documents in the respective pdf files, however, Bid Security is required to be submitted in original before bids submission deadline:</p> <p>I. Technical Bid</p> <p>a) Duly filled-in Form of Technical Bid with following Appendices to Bid:</p> <table border="0" data-bbox="446 1270 1404 1785"> <tr> <td>i)</td> <td>Appendix-A to Bid</td> <td>Special Stipulations</td> </tr> <tr> <td>ii)</td> <td>Appendix-C to Bid</td> <td>Price Adjustment is not applicable</td> </tr> <tr> <td>iii)</td> <td>Appendix-E to Bid</td> <td>Proposed Construction Schedule</td> </tr> <tr> <td>iv)</td> <td>Appendix-F to Bid</td> <td>Method of Performing the Work</td> </tr> <tr> <td>v)</td> <td>Appendix-G to Bid</td> <td>Proposed Personnel</td> </tr> <tr> <td>vi)</td> <td>Appendix-H to Bid</td> <td>List of Major Equipment-Related Items</td> </tr> <tr> <td>vii)</td> <td>Appendix-I to Bid</td> <td>Construction Camp and Housing Facilities</td> </tr> <tr> <td>viii)</td> <td>Appendix-J to Bid</td> <td>Organizational Chart of the Supervisory Staff and Labor</td> </tr> <tr> <td>ix)</td> <td>Appendix-K to Bid</td> <td>List of Sub-Contractors</td> </tr> <tr> <td>x)</td> <td>Appendix-L to Bid</td> <td>Source of Materials</td> </tr> <tr> <td>xi)</td> <td>Appendix-N to Bid</td> <td>Deviations</td> </tr> <tr> <td>xii)</td> <td>Appendix-O to Bid</td> <td>Integrity Pact</td> </tr> <tr> <td>xiii)</td> <td>Appendix-P to Bid</td> <td>Bidder’s Qualification Forms</td> </tr> </table> <p>b) Bid Security as per requirements specified in Section-I Clause IB 15.</p>	i)	Appendix-A to Bid	Special Stipulations	ii)	Appendix-C to Bid	Price Adjustment is not applicable	iii)	Appendix-E to Bid	Proposed Construction Schedule	iv)	Appendix-F to Bid	Method of Performing the Work	v)	Appendix-G to Bid	Proposed Personnel	vi)	Appendix-H to Bid	List of Major Equipment-Related Items	vii)	Appendix-I to Bid	Construction Camp and Housing Facilities	viii)	Appendix-J to Bid	Organizational Chart of the Supervisory Staff and Labor	ix)	Appendix-K to Bid	List of Sub-Contractors	x)	Appendix-L to Bid	Source of Materials	xi)	Appendix-N to Bid	Deviations	xii)	Appendix-O to Bid	Integrity Pact	xiii)	Appendix-P to Bid	Bidder’s Qualification Forms
i)	Appendix-A to Bid	Special Stipulations																																						
ii)	Appendix-C to Bid	Price Adjustment is not applicable																																						
iii)	Appendix-E to Bid	Proposed Construction Schedule																																						
iv)	Appendix-F to Bid	Method of Performing the Work																																						
v)	Appendix-G to Bid	Proposed Personnel																																						
vi)	Appendix-H to Bid	List of Major Equipment-Related Items																																						
vii)	Appendix-I to Bid	Construction Camp and Housing Facilities																																						
viii)	Appendix-J to Bid	Organizational Chart of the Supervisory Staff and Labor																																						
ix)	Appendix-K to Bid	List of Sub-Contractors																																						
x)	Appendix-L to Bid	Source of Materials																																						
xi)	Appendix-N to Bid	Deviations																																						
xii)	Appendix-O to Bid	Integrity Pact																																						
xiii)	Appendix-P to Bid	Bidder’s Qualification Forms																																						

	<p>c) Written Power of Attorney, duly notarized, authorizing the signatory of the bid to act for and on behalf of the Bidder;</p> <p>d) Copies of Original Documents defining the constitution or legal status, place of registration and principal place of business of the bidder and JV partners;</p> <p>e) An affidavit that the Bidder has not been blacklisted pursuant to Sub-Clause 3.1(a)(iii)</p> <p>f) An Affidavit that the Bidder has read and accepts NTDC's SOP for blacklisting of Contractors pursuant to Sub-Clause 3.1(a)(iii)-& ITB 38 of Bid Data Sheet of this document.</p> <p>g) Proof of purchase of Bidding Documents from the Employer;</p> <p>h) Beneficial Ownership Declaration Performa dully filled by the Bidder as per S.R.O 592(I)/2022 available at https://www.ppra.org.pk/doc/sro592.pdf.</p> <p>i) PEC license pursuant to Sub-Clause 3.1a(i); and</p> <p>j) Any other document required to be submitted in accordance with these Bidding Documents.</p> <p>II. Price Bid</p> <p>a) Duly filled-in Form of Price Bid with following Appendices to Bid:</p> <p style="margin-left: 40px;">xiv) Appendix-B to Bid Foreign Currency Requirements (Not Used)</p> <p style="margin-left: 40px;">xv) Appendix-D to Bid Bill of Quantities</p> <p style="margin-left: 40px;">xvi) Appendix-M to Bid Estimated Progress Payments</p> <p>and</p> <p>b) Any other document required to be submitted in accordance with these Bidding Documents.</p>
IB 11.2	<p>Following is added at the end of Sub-Clause IB.11.2:</p> <p>“(f) The maximum J.V. partners shall not be more than three (03).”</p>
IB 12.5	<p>The prices and bid evaluation should be without PST. (Note: - There is no need to give separate column or line item for this purpose in BoQ / Price Schedule).</p>
IB 12.6	<p>Add the following new Sub-Clause IB 12.6:</p> <p>The cost of the material for this transmission line would be 64 Million PKR for calculating insurance charges.</p>

IB 13	<p>Clause IB.13 is substituted with the following:</p> <p>“The unit rates and prices shall be quoted by the Bidder entirely in Pak Rupees. All payments under the contract shall be made in Pak Rupees only. Bidders expecting to incur expenditures in currency(ies) other than Pak Rupees shall manage foreign currency(ies) at their own arrangement. The exchange risk in this regard, if any, shall be deemed to be included in unit rates and prices quoted by the Bidder.”</p>
IB 14.1	<p>The period for Bid validity shall be minimum Sixty (60) days after the date of Bid opening.</p>
IB 15.1	<p>The amount of Bid Security shall be 1.5 Million PKR.</p>
IB 15.2	<p>Sub-Clause IB.15.2 is substituted with the following:</p> <p>“The Bid Security shall be, at the option of the Bidder, in the form of Deposit at Call or a Guarantee issued by a Scheduled Bank in Pakistan or from a foreign bank duly counter guaranteed by a Scheduled Bank in Pakistan in favor of the Project Director (EHV) NTDC Lahore on the prescribed Form annexed to these Documents valid for a period 28 days beyond the Bid Validity date. The Bid Security of Joint Venture shall be in the name of Joint Venture submitting the Bid. For avoidance of doubt, a Bid Security issued by a foreign bank but not counter guaranteed by a Scheduled Bank in Pakistan [<i>or a counter guarantee which impacts rights of Employer to encash the Guarantee on 1st written notice from Bank in Pakistan</i>] shall not be acceptable and rejected as non-responsive.”</p> <p><i>[Any mode for submission of bid security apart from aforementioned like Swift Code or Crossed Cheque shall not be acceptable]</i></p> <p>If a bidder submits a Bid Security that has following discrepancies (to the extent mentioned against each), the Procuring Agency shall request the Bidder to submit a complaint bid security within fourteen (14) days of receiving such request. Failure to provide a complaint bid security within the prescribed period of receiving such a request shall cause the rejection of the bid. Any bid accompanied by bid security with deviation greater than the extent mentioned below shall be rejected:</p> <ol style="list-style-type: none"> i. Bid Security amount is short within 10% of Bid Security amount; and/or ii. Bid Security validity period is short by a maximum of two days iii. Any changes with respect to format/text which does not hurt the right of employer for encashment of the guarantee and does not limit the obligation of the bidder as required in the Bidding Document/Bid Security Format. <p>Note: The validity period of the “Deposit at Call” shall be considered 180 days from the date of issuance.</p> <p>Moreover, the bid shall be considered non-responsive in case of non-</p>

	receipt of original Bid Security (in hard copy) in accordance with ITB 15.1 or 15.2 before the bids closing deadline.
IB 15.6	The following is added at the end of Sub-Clause IB.15.6: “(d) If the Bidder is found involved in corrupt and fraudulent practices.”
IB 17.1	Pre-bid meeting will be held as per the following schedule: Date: [May 04,2026] Time: <u>1100 HRS</u> Venue: Executive Engineer (EHV-I) T/L’C’ Division NGC, 23-Nargis Block Allama Iqbal Town Lahore
IB 18.4	Text of ITB-18.4 is deleted and replaced it with the following: Each bidder shall prepare by filling out the forms completely and without alterations of the documents comprising the bid as described in Clause IB.7
IB.19.1	Sub-Clause 19.1 is substituted by the following: (a) Firms are required to submit their bids through e-PADS only. However, Bid Security is required to be submitted in original before bids submission deadline. (b) The Technical bid should be submitted as a single PDF file named “Tender [Tender Number] - TECHNICAL BID - [Name of Proposing Firm]”. (c) The Financial bid should be submitted as a single PDF file named “Tender [Tender Number] - FINANCIAL BID - [Name of Proposing Firm]”. The Procuring Agency shall reject the bid, if the bid submitted through e-PADS is found corrupt, unreadable or contains a virus.
IB 19.2	Deleted.
IB 19.3	Deleted.
IB 19.4	Deleted.
IB 20.1 (a)	Firms are required to submit their bids through e-PADS only on or before bid submission deadline. However, Bid Security is required to be submitted in original before bids submission deadline. Deadline for Submission of bids: Date: May 18,2026

	<p>Time: 1100 HRS</p> <p>Employer's address for the purpose of Bid Security submission:</p> <p style="text-align: center;">Executive Engineer (EHV-I) T/L'C' Division NGC, 23-Nargis Block Allama Iqbal Town, Lahore-Pakistan. Telephone No. 92-42-35472672</p>
IB 20.1 (b)	Deleted
IB 20.1 (c)	Deleted.
IB 20.1 (d)	Deleted.
IB 21.1 (a)	<p>The Procuring Agency shall not consider for evaluation any Bids that arrive after the deadline for submission of bids including but not limited to following situations;</p> <ol style="list-style-type: none"> i. Against which the Bid Security in original is received after the deadline for submission of Bids. ii. Against which bids are not received through e-PADS within bid submission deadline iii. Against which the bid/pdf file received through e-PADS is found corrupt, unreadable or contains a virus.
IB 21.1(b)	Deleted
IB 22.1	Deleted
IB 22.2	Deleted
23.1	<p>Sub-Clause IB.23.1 is substituted by the following:</p> <p>The Employer shall open the Technical Bids in public at the address, on the date, and time specified herein in the presence of Bidder's designated representatives who choose to attend. The Bidders' representatives who are present shall sign a register evidencing their attendance.</p> <p>Time: 11.30 HRS Date: May 18,2026 Address: Executive Engineer (EHV-I) T/L'C' Division NGC, 23-Nargis Block Allama Iqbal Town, Lahore-Pakistan. Telephone No. 92-42-35472672</p> <p>Further the attendance will also be marked through e-PADS.</p>
23.2	Deleted.
23.3	<p>The Technical Bids, except the Bids rejected pursuant to Sub-Clause IB.21.1 (a) shall be opened one at a time, and the following read out and recorded:</p> <ol style="list-style-type: none"> (a) the name of the Bidder; (b) the receipt of Original Bid Security; and <p>any other details as the Employer may consider appropriate.</p>

23.5	<p>Clauses.23.5 to 23.9, as detailed below, are inserted after clause 23.4.</p> <p>At the end of the evaluation of the Technical Bids, the Employer will invite bidders who have submitted substantially responsive Technical Bids and who have been determined as being qualified for award to attend the opening of the Price Bids. The date, time, and location of the opening of Price Bids will be advised in writing and through e-PADS by the Employer. Bidders shall be given reasonable notice of the opening of Price Bids.</p>
23.6	<p>The Employer will notify Bidders in writing and through e-PADS who have been rejected on the grounds of being substantially nonresponsive to the requirements of the Bidding Documents.</p>
23.7	<p>The Employer shall conduct the opening of Price Bids of all Bidders who submitted substantially responsive Technical Bids, in the presence of Bidders` representatives who choose to attend at the address, on the date, and time specified by the Employer. The Bidder`s representatives who are present shall be requested to sign a register evidencing their attendance.</p> <p>Further the attendance will also be marked through e-PADS.</p>
23.8	<p>Price Bids shall be opened and the following read out and recorded:</p> <ul style="list-style-type: none"> (a) the name of the Bidder; (b) the Bid Prices, including any discounts, cross discounts and alternative offers; (c) any other details as the Employer may consider appropriate. <p>Only Price Bids, discounts, cross discounts and alternative offers (if allowed under Sub-Clause IB.16 hereof) read out and recorded during the opening of Price Bids shall be considered for evaluation</p>
23.9	<p>The Employer shall prepare a record of the opening of Price Bids that shall include, as a minimum: the name of the Bidder, the Bid Price (per lot if applicable), any discounts, cross discounts, and any alternative offers. A copy of the record shall be distributed to all Bidders present at the time of Bid opening.</p>
IB 24.2	<p>Add the following new Sub Clause after IB 24.1:</p> <p>24.2 Bidders and their respective agents, suppliers, sub-contractors, representatives and anyone else on behalf of the bidder will not communicate or attempt to communicate directly or indirectly with the Employer, including any employees, directors, officers, agents or representatives of any of them during any part of the Competitive Bidding Process, except as expressly directed or permitted by the Employer. Bidders will also not engage in any form of political or other lobbying whatsoever with respect to their Bids, or otherwise attempt to influence the outcome of the Competitive Bidding Process. In the event of any such communications or lobbying, Employer may at any time reject any Bid by that Bidder without further consideration.</p>

IB 25.1	<p>Add the following at the end of Sub-Clause 25.1:</p> <p>The Employer may, at his discretion, ask any Bidder for confirmation/submission of missing information to clarify its Bid. However, the Employer does not have an obligation to request any additional information or clarification with respect to missing or deficient information in a Bid. Any clarification submitted by a Bidder that is not in response to a request by the Employer shall not be considered.</p>
IB 25.2	<p>Add the following new Sub-Clause:</p> <p>If a Bidder does not provide clarifications of its Bid by the date and time set in the Employer's request for clarification, its Bid may be rejected.</p>
IB 26.1	<p>Sub-Clause 26.1 is substituted by the following:</p> <p>“The Employer will determine whether Bid is substantially responsive to the requirements of the Bidding Documents.”</p>
IB 26.2	<p>Sub-Clause 26.2 is substituted by the following:</p> <p>“A substantially responsive Technical Bid is one which (i) meets the eligibility criteria; (ii) has been properly signed; (iii) is accompanied by the required Bid Security; (iv) meets the qualification criteria delineated at Sub-Clause IB.3A&B hereof; and (v) conforms to all the terms, conditions and specifications of the Bidding Documents, without material deviation or reservation.</p> <p>A substantially responsive Price Bid is one which (i) has been properly signed and (ii) conforms to all the terms, conditions and specifications of the Bidding Documents, without material deviation or reservation.</p> <p>A material deviation or reservation is one (i) which affects in any substantial way the scope, quality or performance of the Works; (ii) which limits in any substantial way, inconsistent with the Bidding Documents, the Employer's rights or the Bidder's obligations under the Contract; or (iii) adoption/rectification whereof would affect unfairly the competitive position of other Bidders presenting substantially responsive bids.</p> <p>Any minor informality or non-conformity or irregularity in a Bid which does not constitute a material deviation may be waived by the Employer, provided such waiver does not prejudice or affect the relative ranking of any Bidder.”</p>
IB 26.4	<p>Following Sub-Clauses are added at the end of Sub-Clause 26.3:</p> <p>The Employer may reject any Bid as non-responsive if found materially incomplete, obscure, irregular or omits any material information required to be submitted by the Bidding Documents.</p>

IB 27.3	<p>Following Sub Clause is added after Sub Clause 27.2:</p> <p>If as a result of arithmetic correction, the Bid Price is increased substantially, the Bidder may be asked to increase the amount of its Bid Security accordingly by submitting its amendment within fifteen (15) days from issuing date of such notification. If the Bidder fails to provide the requisite amendment of the Bid Security within the stipulated period, his Bid will be held substantially non-responsive and will be rejected.</p>
IB 28.4	<p>Following is added at the end of Sub-clause IB 28.4: “or the employer may require the successful Bidder to balance his bid.”</p> <p>In case of front-end loading or unbalanced price of any BoQ item, the Employer reserve the right to adjust the price with other BoQ items provided that ceiling of overall price remains the same.</p>
IB 28.5	<p>Following new Sub Clause is added after IB 28.4:</p> <p>The Employer will evaluate the Bids, including all clarifications, additional information, modifications and negotiated changes, by applying the Eligibility and Qualification Criteria. Without limiting the particular criteria, the Employer may take into account the following in the Evaluation of Bids:</p> <ol style="list-style-type: none"> i. Non-performance by a Bidder on previous contracts with Employer or others; ii. The quality of a Bidder’s performance on previous contracts with Employer or others; iii. Anticipated or ongoing claims with or in connection with a Bidder; iv. Any security of safety concerns which Employer may have in respect of a Bidder or its facilities, subcontractors or suppliers; v. The results of any interview with a Bidder or supplied references; or vi. Any knowledge of or experience with a Bidder or its principals, directions, officers and employees. <p>The Employer may independently verify any information (including conducting credit, reference and other checks with respect to a Bidder) and consider such findings in its evaluation.</p> <p>Employer is not required to inform Bidders of how Bids were ranked in the evaluation process.</p>
IB 28.6	<p>Add the following new Sub-Clause</p> <p>The Employer’s evaluation of a Bid will exclude and will not take into account the Provincial Sales Tax (PST).</p>

IB 29.1	<p>Add the words “for the respective Lot(s)” after the words “evaluated Bid Price” in 3rd line of this Sub-Clause.</p> <p>Add the following at the end of this Sub-Clause, if applicable:</p> <p>“Provided further in case a Bidder is determined to be the lowest evaluated substantially responsive in more than one Lot, the aggregate requirements delineated under Sub-Clause IB.3 hereof shall apply.”</p>
IB 29.2	<p>Following text is added at the end of Sub Clause 29.2</p> <p>The Employer reserves the right to assess the capacity and capability of the Bidder, to successfully execute the scope of work covered under the Bidding Documents within stipulated completion period. This assessment may inter alia include for (i) document verification; (ii) details of work executed, work in hand, anticipated in future; (iii) details of tools & plant; (iv) availability of requisite key personnel (v) financial resources; (vi) details of quality system in place; (vii) past experience and performance; (viii) customer feedback (ix) Bank’s feedback etc.</p>
IB 30.1	<p>The Employer reserves the right to reject any bid on the following accounts, apart from those mentioned in the bidding documents:</p> <ol style="list-style-type: none"> i. Bidding Documents are not purchased by the bidder. ii. Bid is not received by the due date and time specified. iii. Cost of the bidding documents is not remitted. iv. Bid is not accompanied by Bid security as specified in the document; Bid security is inadequate; Bid guarantee is not in the specified format. v. Bid does not cover the complete scope of work. vi. Bid does not contain all required particulars as per Schedules & Forms prescribed in the bidding documents. vii. Deviations, conditionality or reservations have been introduced to any part of the bidding documents which may not be acceptable to the Employer in its sole discretion. viii. Bidder does not respond promptly and thoroughly to the request for supplementary information required for the evaluation of his Bid. ix. Bid does not meet minimum acceptable standards of completeness, consistency and detail. x. Bid received from any Black listed Firm / Contractor. <p>If at any time it is found that a material misrepresentation of facts is made or uncovered; the information submitted by the bidder concerning his qualification was false and materially inaccurate or incomplete. If the bidder is the Lead Member of a consortium, then the entire consortium may be disqualified/ rejected.</p>
IB 32.1	<p>The Bidder shall furnish an unconditional Performance Security, equal to ten percent (10%) of the Contract Price in the form prescribed in the conditions of Contract.</p>

IB 33	Text of Clause IB.33 is deleted and substituted as follows: Within fourteen (14) days from the date of furnishing of acceptable Performance Security under the Conditions of Contract, the successful bidder shall depute its representative duly authorized for formal signing of the Contract Agreement, Form of which is provided in the Bidding Documents.
--------------	---

IB 37	The following clause is hereby added: - (GRIEVANCE REDRESSAL & COMPLAINT REVIEW MECHANISM) Any party can file its written complaint against the eligibility parameters or any other terms and conditions prescribed in the prequalification or bidding documents found contrary to provision of Procurement Regulatory Framework, and the same shall be addressed by the GRC well before the bid submission deadline.
37.1	Any Bidder feeling aggrieved by any act of the procuring agency after the submission of his bid may lodge a written complaint concerning his grievances not later than seven days of the announcement of technical evaluation report and five days after issuance of final evaluation report.
37.2	In case, the complaint is filed against the technical evaluation report, the GRC shall suspend the procurement proceedings.
37.3	In case, the complaint is filed after the issuance of the final evaluation report, the complainant cannot raise any objection on technical evaluation of the report: Provided that the complainant may raise the objection on any part of the final evaluation report in case where single stage one envelop bidding procedure is adopted.
37.4	The GRC, in both the cases shall investigate and decide upon the complaint within ten days of its receipt.
37.5	Any bidder or the procuring agency not satisfied with the decision of the GRC may file Appeal before the Appellate Committee of the Authority on prescribed format after depositing the Prescribed fee.
37.6	The Committee, upon receipt of the Appeal against the decision of the GRC complete in all respect shall serve notices in writing upon all the parties to appeal.
37.7	The committee shall call the record from the concerned procuring agency or the GRC as the case may be, and the same shall be provided within prescribed time.
37.8	The committee may after examination of the relevant record and hearing all the concerned parties, shall decide the complaint within fifteen (15) days of receipt of the Appeal.
37.9	The decision of the Committee shall be in writing and shall be signed by the Head and each Member of the Committee. The decision of the committee shall be final

IB 38	<p>The following Clause is hereby inserted: -</p> <p style="text-align: center;">(Mechanism of Blacklisting)</p> <p>38.1. The Procuring Agency shall bar for not more than the time prescribed in Rule-19 of the Public Procurement Rules, 2004, from participating in their respective procurement proceedings, bidder or contractor who either:</p> <ol style="list-style-type: none"> i. Involved in corrupt and fraudulent practices as defined in Rule-2 of Public Procurement Rules; ii. Fails to perform his contractual obligations; iii. Fails to abide by the its securing declaration; and iv. Submits false information (or) hides information on Beneficial Ownership Declaration Performa under S.R.O 592(I)/2022.
38.2	<p>The show cause notice shall contain: (a) precise allegation, against the bidder or contractor; (b) the maximum period for which the Procuring Agency proposes to debar the bidder or contractor from participating in any public procurement of the Procuring Agency; and (c) the statement, if needed, about the intention of the Procuring Agency to make a request to the Authority for debarring the bidder or contractor from participating in public procurements of all the procuring agencies.</p>
38.3	<p>The procuring agency shall give minimum of seven days to the bidder or contractor for submission of written reply of the show cause notice</p>
38.4	<p>In case, the bidder or contractor fails to submit written reply within the requisite time, the Procuring Agency may issue notice for personal hearing to the bidder or contractor/ authorize representative of the bidder or contractor and the procuring agency shall decide the matter on the basis of available record and personal hearing, if availed.</p>
38.5	<p>In case the bidder or contractor submits written reply of the show cause notice, the Procuring Agency may decide to file the matter or direct issuance of a notice to the bidder or contractor for personal hearing.</p>
38.6	<p>The Procuring Agency shall give minimum of seven days to the bidder or contractor for appearance before the specified officer of the Procuring Agency for personal hearing. The specified officer shall decide the matter on the basis of the available record and personal hearing of the bidder or contractor, if availed</p>
38.7	<p>The procuring Agency shall decide the matter within fifteen days from the date of personal hearing unless the personal hearing is adjourned to a next date and in such an eventuality, the period of personal hearing shall be reckoned from the last date of personal hearing.</p>
38.8	<p>The Procuring Agency shall communicate to the bidder or contractor the order of debarring the bidder or contractor from participating in any public procurement</p>

	with a statement that the bidder or contractor may, within thirty days, prefer a representation against the order before the Authority.
38.9	Such blacklisting or barring action shall be communicated by the procuring agency to the Authority and respective bidder or bidders in the form of decision containing the grounds for such action. The same shall be publicized by the Authority after examining the record whether the procedure defined in blacklisting and debarment mechanism has been adhered to by the procuring agency.
38.10	The bidder may file the review petition before the Review Petition Committee Authority within thirty days of communication of such blacklisting or barring action after depositing the prescribed fee and in accordance with “Procedure of filing and disposal of review petition under Rule-19(3) Regulations, 2021”. The Committee shall evaluate the case and decide within ninety days of filing of review petition
38.11	The committee shall serve a notice in writing upon all respondent of the review petition. The notices shall be accompanied by the copies of review petition and all attached documents of the review petition including the decision of the procuring agency. The parties may file written statements along with essential documents in support of their contentions. The Committee may pass such order on the representation may deem fit.
38.12	The Authority on the basis of decision made by the committee either may debar a bidder or contractor from participating in any public procurement process of all or some of the procuring agencies for such period as the deemed appropriate or acquit the bidder from the allegations. The decision of the Authority shall be final.

Annexure - 1 to Bid Data Sheet

FORMAT FOR POWER OF ATTORNEY FOR SIGNING OF BID**POWER OF ATTORNEY**

Know all men by these presents, we _____ (name and address of the registered office of the Bidder) do hereby constitute, appoint and authorize Mr. / Ms. _____ R/o _____ (name and address of residence) who is presently employed with us and holding the position of _____, as our attorney, to do in our name and on our behalf, all such acts, deeds and things necessary in connection with or incidental to the bid of the (please state the name and address of the bidder) for Bidding Document No. **XEN-EHV-TLCLHR-01-2026: Construction and Completion of Civil Works, Erection, Stringing, Testing & Commissioning for Conversion of Tower Nos. 42 & 43 of 220kV Double Circuit Twin Bundle T/line Sheikhpura -Ravi Circuit I & II from Suspension Type to Tension Type** (the "tender"), including signing and submission of all documents and providing information / responses to National Grid Company (NGC) of Pakistan Limited, representing us in all matters in connection with our bid for the said tender.

We hereby agree to ratify all acts, deeds and things done by our said attorney pursuant to this Power of Attorney and agree that all acts, deeds and things done by our aforesaid attorney shall and shall always be deemed to have been done by us.

For

(Signature)

(Name, Title, Email ID and Address)

Accepted

..... (Signature)

(Name, Title, Email ID and Address of the Attorney)

ACKNOWLEDGMENT

Before me, a Notary Public for and in the City of _____, this _____ of _____ 20__ personally came and appeared:

NAME

IDENTIFICATION DOCUMENT

Known to me to be the same person/s who executed the foregoing Special Power of Attorney in favor of _____, and acknowledged to me the same is/are his/her/their free and voluntary act and deed.

IN WITNESS WHEREOF, I have hereunto set my hand and affixed my notarial seal, the date and place above written.

NOTARY PUBLIC

Annexure - 2 to Bid Data Sheet

A. FORM OF UNDERTAKING BY THE JOINT VENTURE PARTNERS**(On Company's Letter Head)**

THIS JOINT DEED OF UNDERTAKING executed on this day of Two Thousand and by a company incorporated under the laws of and having its Registered Office at (hereinafter called the "Party No. 1" which expression shall include its successors, executors and permitted assigns) and M/s a company incorporated under the laws of and having its Registered Office at (hereinafter called the "Party No. 2" which expression shall include its successors, executors and permitted assigns) and M/s a Company incorporated under the laws of and having its Registered Office at (hereinafter called the "Party No. 3" which expression shall include its successors, executors and permitted assigns) for the purpose of making a bid and entering into a contract [hereinafter called the "Contract" {in case of award}] against the Identification No. for _____ associated with _____ of (hereinafter called the "**Employer**").

WHEREAS the Party No. 1, Party No. 2 and Party No. 3 have entered into an Agreement dated AND WHEREAS the Employer invited bids for the design, manufacture, Supply of Equipment Materials stipulated in the bidding documents under _____ associated with _____.

AND WHEREAS Clause 2, Section-ITB and 'Qualification & Evaluation Requirement of the Bidder'(clause 13, 24 & 26 of ITB), and technical provisions forming part of the bidding documents, inter-alia, stipulates that an Undertaking of two or more qualified partners, meeting the requirements of 'Qualification & Evaluation Requirement of the Bidder', as applicable may bid, provided, the Joint Venture fulfills all other requirements under Clause 2, 13, 24 & 26 of ITB and in such a case, the Letter of Bids (Bid Form) shall be signed by the Partner –In Charge so as to legally bind all the Partners of the Joint Venture, who will be jointly and severally liable to perform the Contract and all obligations hereunder.

The above clause further states that this Undertaking shall be attached to the bid and the Contract performance guarantee will be as per the format enclosed with the bidding document without any restrictions or liability for either party.

AND WHEREAS the bid is being submitted to the Employer vide proposal No. dated by Party No. 1 based on this Undertaking between all the parties; under these presents and the bid in accordance with the requirements of Clause 2, 13, 24 & 26 (Section-ITB) has been signed by all the parties.

NOW THIS UNDERTAKING WITNESSETH AS UNDER:

In consideration of the above premises and agreements all the parties of this Deed of Undertaking do hereby declare and undertake:

1. In requirement of the award of the Contract by the Employer to the Joint Venture Partners, we, the Parties do hereby undertake that M/s..... the Party No.1, shall act as Lead Partner and further declare and confirm that we the parties to the Joint Venture shall jointly and severally be bound unto the Employer for the successful performance of the Contract and shall be fully responsible for the design, manufacture, Supply, and successful performance of the equipment in accordance with the Contract:
2. In case of any breach or default of the said Contract by any of the parties to the Joint Venture, the party(s) do hereby undertake to be fully responsible for the successful performance of the Contract and to carry out all the obligations and responsibilities under the Contract in accordance with the requirements of the Contract.
3. Further, if the Employer suffers any loss or damage on account of any breach in the Contract or any shortfall in the performance of the equipment in meeting the performances guaranteed as per the specification in terms of the Contract, the Party(s) of these presents undertake to promptly make good such loss or damages caused to the Employer, on its demand without any demur. It shall not be necessary or obligatory for the Employer to proceed against Lead Partner to these presents before proceeding against or dealing with the other Party(s), the Employer can proceed against any of the parties who shall be jointly and severally liable for the performance and all other liabilities/obligations under the Contract to the Employer.
4. The financial liability of the Parties of this Deed of Undertaking to the Employer, with respect to any of the claims arising out of the performance or non-performance of the obligations set forth in this Deed of Undertaking, read in conjunction with the relevant conditions of the Contract shall, however not be limited in any way so as to restrict or limit the liabilities or obligations of any of the Parties of this Deed of Undertaking.
5. It is expressly understood and agreed between the Parties to this Undertaking that the responsibilities and obligations of each of the Parties shall be as delineated in Annexure attached with this undertaking. It is further undertaken by the parties that the above sharing of responsibilities and obligations shall not in any way be a limitation of joint and several responsibilities of the Parties under the Contract.
6. It is also understood that this Undertaking is provided for the purposes of undertaking joint and several liabilities of the partners to the Joint Venture for submission of the bid and performance of the Contract if awarded and that this Undertaking shall not be deemed to give rise to any additional liabilities or obligations, in any manner or any law, on any of the Parties to this Undertaking or on the Joint Venture, other than the express provisions of the Contract.

7. This Undertaking shall be construed and interpreted in accordance with the provisions of the Contract.
8. In case of an award of a Contract, we the parties to this Deed of Undertaking do hereby agree that we shall be jointly and severally responsible for furnishing a Contract performance security from a bank in favour of the Employer in the currency/currencies of the Contract.
9. It is further agreed that this Deed of Undertaking shall be irrevocable and shall form an integral part of the bid and shall continue to be enforceable till the Employer discharges the same or upon the completion of the Contract in accordance with its provisions, whichever is earlier. It shall be effective from the date first mentioned above for all purposes and intents.

IN WITNESS WHEREOF, the Parties to this Deed of Undertaking have through their authorized representatives executed these presents and affixed Common Seals of their companies, on the day, month and year first mentioned above.

Common Seal of For Lead Partner (Party No.-1)
has been affixed in my/ our For and on behalf of M/s
presence pursuant to Board of
Director's Resolution dated

Name

Designation

Signature (Signature of the authorized
representative)

WITNESS:

I.

II.

Common Seal of For Party No.-2
has been affixed in my/ our For and on behalf of M/s.....
presence pursuant to Board of
Director's Resolution dated (Signature of the authorized
representative)

Name

Designation

Signature

WITNESS:

I.

II.

Common Seal of
has been affixed in my/ our
presence pursuant to Board of
Director’s Resolution dated

For Party No.-3
For and on behalf of M/s.
.....

Name

Designation

Signature

(Signature of the authorized
representative)

WITNESS:

I.

II.

Notes:

1. In the event that the successful Bidder is a joint venture formed of two or more companies, the Employer requires that the parties of the joint venture accept joint and several liabilities for all obligations under the Contract.
2. The maximum number of J.V partners is three (03).

Annexure - 3 to Bid Data Sheet

B. FORM OF LETTER OF INTENT BY JV PARTNERS TO ENTER INTO JV AGREEMENT

THIS LETTER OF INTENT signed on this..... day of..... Two Thousand andby..... a company incorporate under the laws of and having its Registered Office at..... (hereinafter called the "Party No.1" which expression shall include its successors, executors and permitted assigns) and M/s.....a company incorporated under the laws of..... and having its Registered Office at..... (hereinafter called the "Party No.2" which expression shall include its successors, executors and permitted assigns) and M/s..... a Company incorporated under the laws of and having its Registered Office at..... (hereinafter called the "Party No.3" which expression shall include its successors, executors and permitted assigns) for the purpose of making a bid and entering into a contract [hereinafter called the "Contract" {in case of award}] against the Specification No.....for _____ associated with _____ of (hereinafter called the "**Employer**").

WHEREAS the Party No.1, Party No.2 and Party No.3 intend to enter into a Joint Venture Agreement

AND WHEREAS the Employer invited bids as per the above mentioned Specification for the design, manufacture, Supply of Equipment Materials stipulated in the bidding documents under _____ associated with _____.

AND WHEREAS Clause 2, Section-ITB and 'Qualification & Evaluation Requirement of the Bidder'(clause 13, 24 & 26 of ITB), and technical provisions forming part of the bidding documents, inter-alia, stipulates that two or more qualified partners, meeting the requirements of Clause 2, Section-ITB and 'Qualification & Evaluation Requirement of the Bidder'(clause 13, 24 & 26 of ITB), as applicable may bid, provided, they submit a Letter of Intent to enter into Joint Venture Agreement and the Joint Venture Partners fulfill all other requirements under Clause 2, Section-ITB and 'Qualification & Evaluation Requirement of the Bidder'(clause 13, 24 & 26 of ITB), and technical provisions forming part of the bidding documents and in such a case, the Letter of Bid (Bid Form) shall be signed by all the proposed partners so as to legally bind all the Partners of the Joint Venture, who will be jointly and severally liable to perform the Contract by entering into Joint Venture Agreement as per proforma specified in this Section IV. Bidding Forms of the Bidding Documents which will be legally binding on all partners and all obligations hereunder.

The above clause further states that this Letter of Intent shall be attached to the bid and the Contract performance guarantee will be as per the format enclosed with the bidding document without any restrictions or liability for either party.

AND WHEREAS the bid is being submitted to the Employer vide proposal No.....dated..... by Party No.1 based on this Letter of Intent between all the parties; under these presents and the bid in accordance with the requirements of Clause 4.1, Section-ITB and 'Qualification Requirement of the Bidder', Section-Evaluation and Qualification Criteria, has been signed by all the parties.

NOW THIS UNDERTAKING WITNESSED AS UNDER:

In consideration of the above premises and agreements all the parties of this Letter of Intent do hereby declare and undertake:

1. In requirement of the award of the Contract by the Employer to the Joint Venture Partners, we, the Parties do hereby undertake that M/s..... the Party No.1, shall act as Lead Partner and further declare and confirm that we the parties to the Joint Venture shall jointly and severally be bound unto the Employer for the successful performance of the Contract and shall be fully responsible for the design, manufacture, Supply, and successful performance of the equipment in accordance with the Contract for which we shall enter into Joint Venture Agreement as per proforma specified in this Section IV. Bidding Forms of the Bidding Documents which will be legally binding on all partners:
2. If the Contract is awarded to Joint Venture then in case of any breach or default of the said Contract by any of the parties to the Joint Venture, the party(s) will be fully responsible for the successful performance of the Contract and to carry out all the obligations and responsibilities under the Contract in accordance with the requirements of the Contract.
3. Further, if the Employer suffers any loss or damage on account of any breach in the Contract or any shortfall in the performance of the equipment in meeting the performances guaranteed as per the specification in terms of the Contract, the Party(s) of these presents will promptly make good such loss or damages caused to the Employer, on its demand without any demur. It shall not be necessary or obligatory for the Employer to proceed against Lead Partner to these presents before proceeding against or dealing with the other Party(s), the Employer can proceed against any of the parties who shall be jointly and severally liable for the performance and all other liabilities/obligations under the Contract to the Employer.
4. The financial liability of the Parties of the Deed of Undertaking to the Employer in the event of award of Contract on the Joint Venture, with respect to any of the claims rising out of the performance or non-performance of the obligations set forth in the Deed of Undertaking, read in conjunction with the relevant conditions of the Contract shall, however not be limited in any way so as to restrict or limit the liabilities or obligations of any of the Parties of the Deed of Undertaking.
5. It is expressly understood and agreed between the Parties to this Letter of Intent that the responsibilities and obligations of each of the Parties shall be as delineated in Annexure attached with this Letter of Intent. It is further undertaken by the parties that the above sharing of responsibilities and obligations shall not in any way be a limitation of joint and several responsibilities of the Parties under the Contract in the event of award on Joint Venture.
6. It is also understood that this Letter of Intent is provided for the purposes of undertaking joint and several liabilities of the partners to the Joint Venture for submission of the bid and performance of the Contract if awarded and that this Letter of Intent shall not be deemed to give rise to any additional liabilities or obligations, in any manner or any law, on any of the Parties to this Letter of Intent or on the Joint Venture, other than the express provisions of the Contract.

7. This Letter of Intent shall be construed and interpreted in accordance with the provisions of the Contract.
8. In case of an award of a Contract, we the parties to this Letter of Intent do hereby agree that we shall enter into Joint Venture Agreement as per proforma specified in this Section IV. Bidding Forms of the Bidding Documents which will be legally binding on all partners and we shall be jointly and severally responsible for furnishing a Contract performance security from a bank in favour of the Employer in the currency/currencies of the Contract.
9. It is further agreed that this Letter of Intent shall be irrevocable and shall form an integral part of the bid. It shall be effective from the date first mentioned above for all purposes and intents.

IN WITNESS WHEREOF, the Parties to this Letter of Intent have through their authorized representatives executed these presents and affixed Common Seals of their companies, on the day, month and year first mentioned above.

Common Seal of
has been affixed in my/ our
presence pursuant to Board of
Director's Resolution dated

For Lead Partner (Party No.-1)
For and on behalf of M/s
.....

Name
Designation

(Signature of the authorized
representative)

Signature

WITNESS :

I.

II.

Common Seal of
has been affixed in my/ our
presence pursuant to Board of
Director's Resolution dated

For Party No.-2
For and on behalf of M/s.....

Name

(Signature of the authorized
representative)

Designation

Signature

WITNESS :

I.

II.

Common Seal of
has been affixed in my/ our
presence pursuant to Board of
Director’s Resolution dated

For Party No.-3
For and on behalf of M/s.
.....

Name

(Signature of the authorized
representative)

Designation

Signature

WITNESS:

I.

II.

Notes:

1. In the event that the successful Bidder is a joint venture formed of two or more companies, the Employer requires that the parties to the joint venture accept joint and several liabilities for all obligations under the Contract.
2. The maximum number of J.V. partners is three (3).

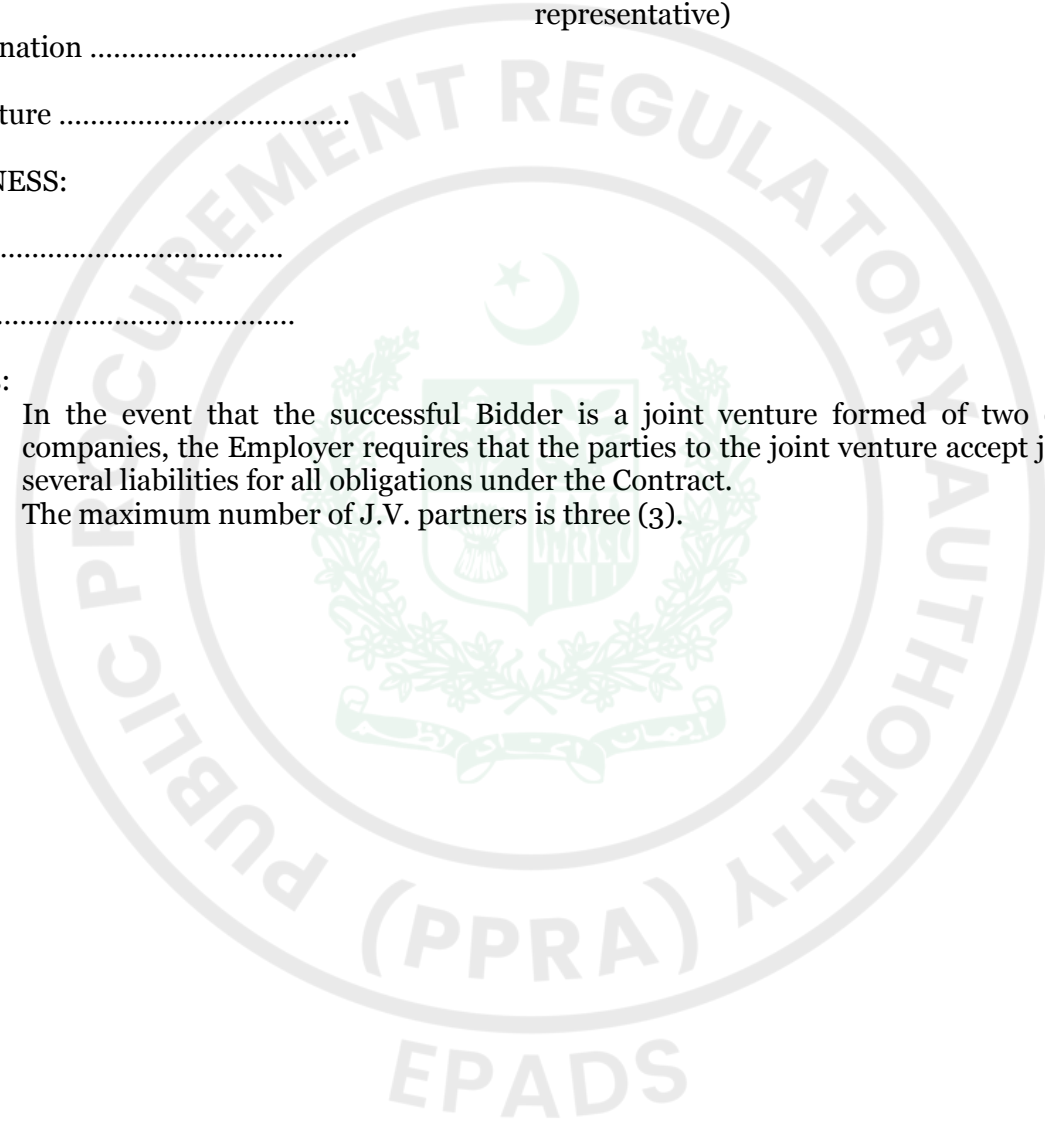

Section –III: FORM OF TECHNICAL & PRICE BID & APPENDICES TO BID

Sr. No.	Description	Page No.
1.	Form of Technical Bid	A-4
2.	Form of Financial/Price Bid	A-6
Appendices to Bid		
3.	Appendix A to Bid: Special Stipulations	A-8
4.	Appendix B to Bid: Foreign Currency Requirements	A-10
5.	Appendix C to Bid: Price Adjustment	A-11
6.	Appendix D to Bid: Bill of Quantities	A-14
7.	Appendix E to Bid: Proposed Construction Schedule	A-22
8.	Appendix F to Bid: Method of Performing Works	A-24
9.	Appendix G to Bid: Proposed Personnel	A-25
10.	Appendix H to Bid: Equipment	A-27
11.	Appendix I to Bid: Construction Camp and Housing Facilities	A-30
12.	Appendix J to Bid: Organization Chart for Supervisory Staff	A-31
13.	Appendix K to Bid: List of Subcontractors	A-32
14.	Appendix L to Bid: Source of Material	A-33
15.	Appendix M to Bid: Estimated Progress Payments	A-34

16.	Appendix N to Bid: Deviations	A-35
17.	Appendix O to Bid: Integrity Pact	A-37
18.	Appendix P to Bid: Bidder's Qualification Forms	
QF-1	General Information	A-39
QF-2	Construction Experience	A-40
QF-3	Performance Certificate	A-41
QF-4	Current Contract Commitments	A-42
QF-5	Financial Data	A-43
QF-6	Annual Turnover Data	A-44
QF-7	Financial Resources	A-45
QF-8	Bank Certificate	A-46
QF-9	Pending Litigation	A-47
19.	Standard Forms	
I	Bid Security (Bank Guarantee)	A-49
II	Form of Performance Security	A-51
III	Form of Contract Agreement	A-53
IV	Mobilization Advance Guarantee/Bond	A-55

Section III

Forms of Bid and Appendices to Bid

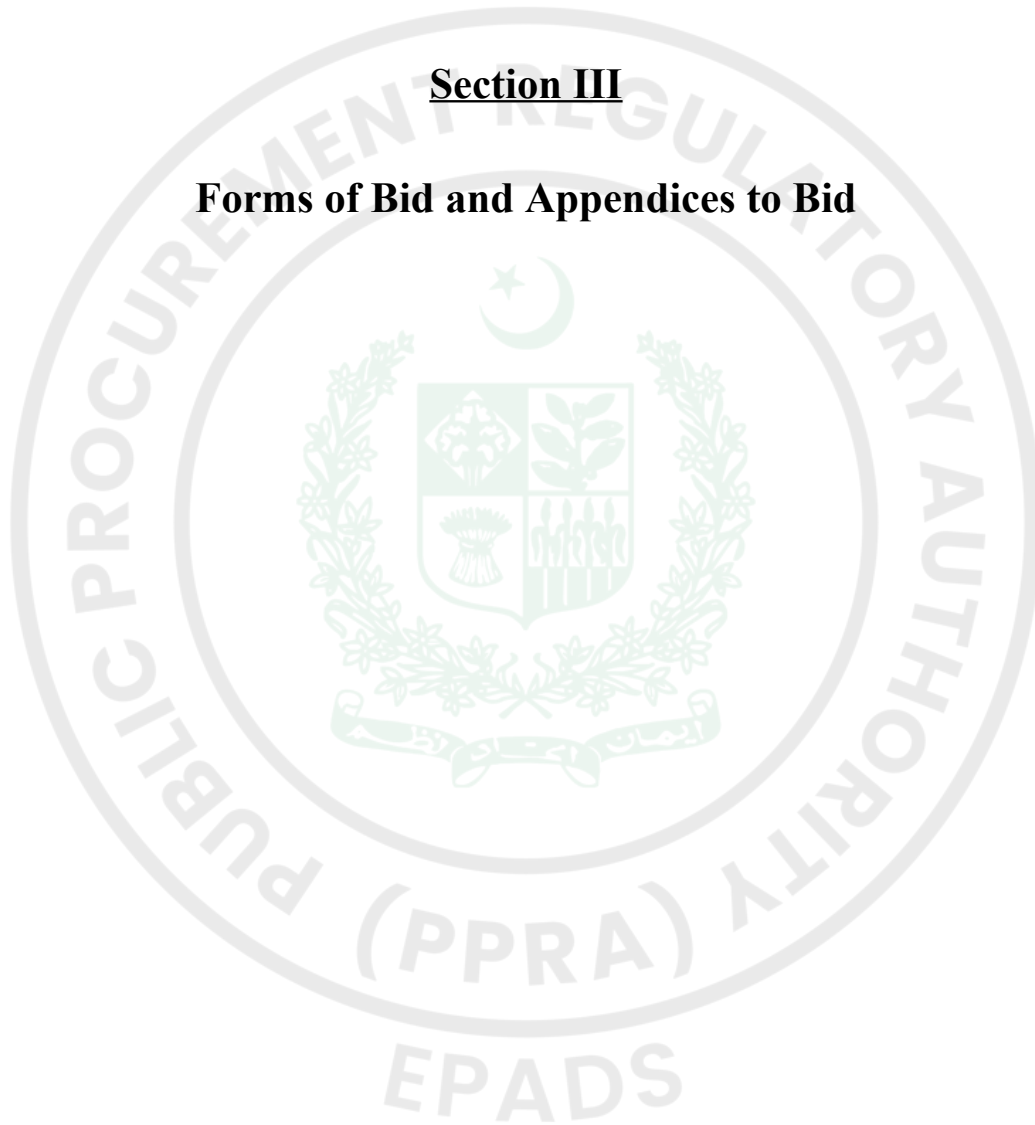

Form of Technical Bid

Bid Reference No. _____

(Name of Contract/Works)

To:

We, the undersigned, declare that:

- (a) a) We have examined the Bidding Documents including Instructions to Bidders, Bidding Data, Conditions of Contract, Contract Data, Specifications, Drawings, if any, Schedule of Prices and Addenda Nos. _____ in accordance with Instructions to Bidders (IB) 9 for the execution of the above-named Works, we, the undersigned, being a company doing business under the name of and address _____ and being duly incorporated under the laws of Pakistan hereby offer to execute and complete such Works and remedy any defects therein in conformity with the said Documents including Addenda.
- (b) Our Bid consisting of the Technical Bid and the Price Bid shall be valid for a period of days from the date fixed for the bid submission deadline in accordance with the Bidding Documents, and it shall remain binding upon us and may be accepted at any time before the expiration of that period;
- (c) As security for due performance of the under takings and obligations of our bid, we submit here with a Bid security, in the amount specified in Bidding Data Sheet, which is valid (at least) 28 days beyond validity of Bid itself.
- (d) We undertake, if our Bid is accepted, to commence the Works and to deliver and complete the Works comprised in the Contract within the time(s) stated in Contract Data.
- (e) We are not participating, as a Bidder or as a subcontractor, in more than one bid in this bidding process, other than alternative offers submitted in accordance with IB16 (as applicable).
- (f) We agree to permit Employer or its representative to inspect our accounts and records and other documents relating to the bid submission and to have them audited by auditors. This permission is extended for verification of any information provided in our

Technical Bid which comprises all documents enclosed herewith in accordance with IB.11.1 of the Bidding Data Sheet.

Name.....
.....

In the capacity
of.....

Signed.....
.....

Duly authorized to sign the Bid for and on behalf
of.....

Date.....

Address.....
.....

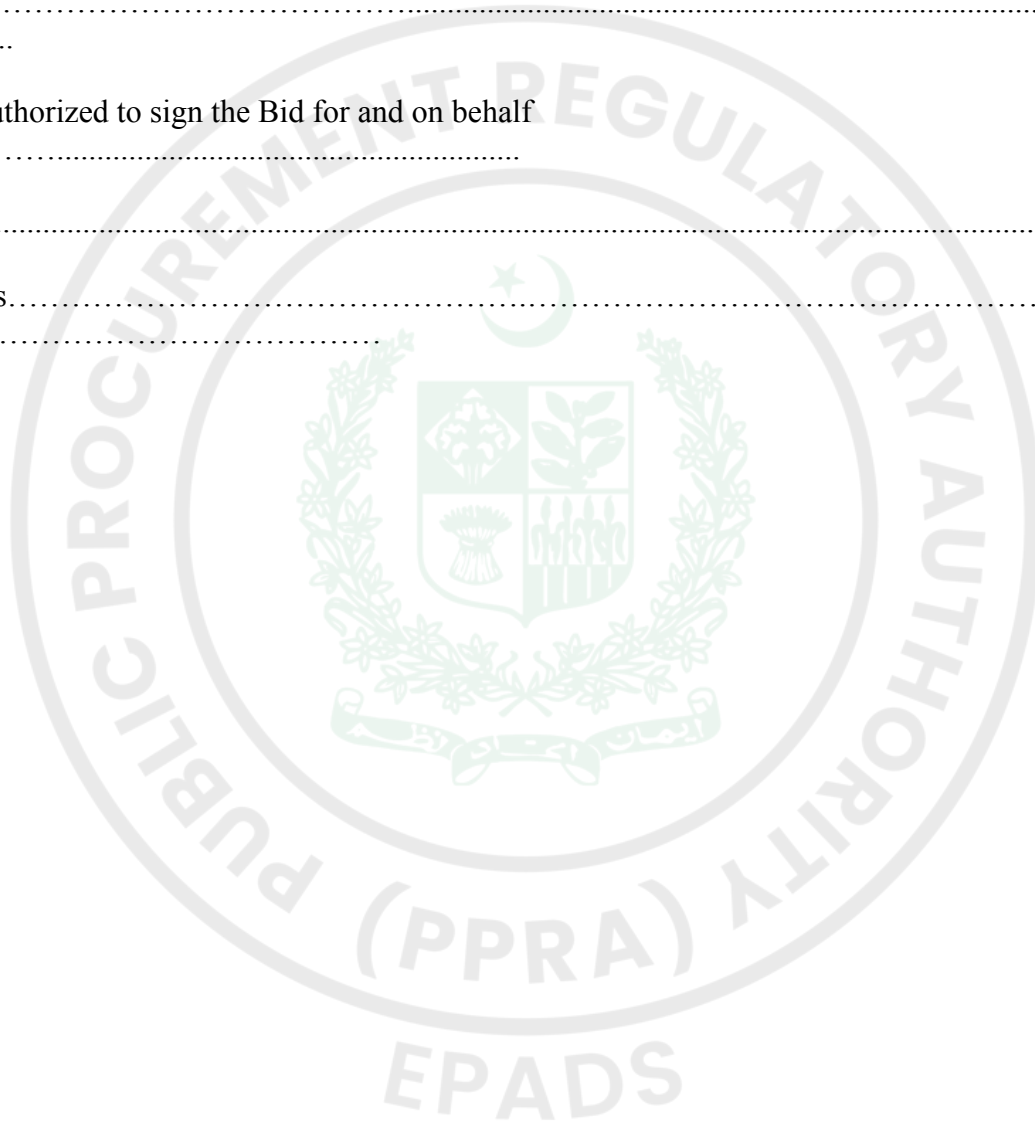

Form of Price Bid

Bid Reference No. _____

(Name of Contract/Works)

To:

We, the undersigned, declare that:

- (a) We have examined and have no reservations to the Bidding Documents, including Addenda issued in accordance with Instructions to Bidders (IB)9;
- (b) The total price of our Bid, excluding any discounts offered including Addenda thereto for the Total Bid Price of Rupees

(Rupees _____)

or such other sum as may be ascertained in accordance with the said Documents.

- (c) The discounts offered and the methodology for their application is:
- (d) Our Bid shall be valid for a period of days from the date fixed for the bid submission deadline in accordance with the Bidding Documents, and it shall remain binding upon us and may be accepted at any time before the expiration of that period;
- (e) If our Bid is accepted, we commit to obtain a performance security in accordance with the Bidding Documents;
- (f) We understand that this bid, together with your written acceptance thereof included in your notification of award, shall constitute a binding contract between us, until a formal contract is prepared and executed and we do hereby declare that the Bid is made without any collusion, comparison of figures or arrangement with any other bidder for the Works.
- (g) We understand that you are not bound to accept the lowest evaluated bid or any other bid that you may receive.
- (h) We agree to permit Employer or its representative to inspect our accounts and records and other documents relating to the bid submission and to have them audited by auditors. This permission is extended for verification of any information provided in our

Technical Bid which comprises all documents enclosed herewith in accordance with IB.11.1 of the Bidding Data Sheet.

- (i) If awarded the contract, the person named below shall act as Contractor’s Representative.
- (j) We do hereby declare that the Bid is made without any collusion, comparison of figures or arrangement with any other person or persons making a bid for the Works.

Name.....
.....

In the capacity
of.....

Signed.....
.....

Duly authorized to sign the Bid for and on behalf
of.....

Date.....

Address.....
.....

Witness:

Signature:.....

Name.....

Address.....
.....

Occupation:.....

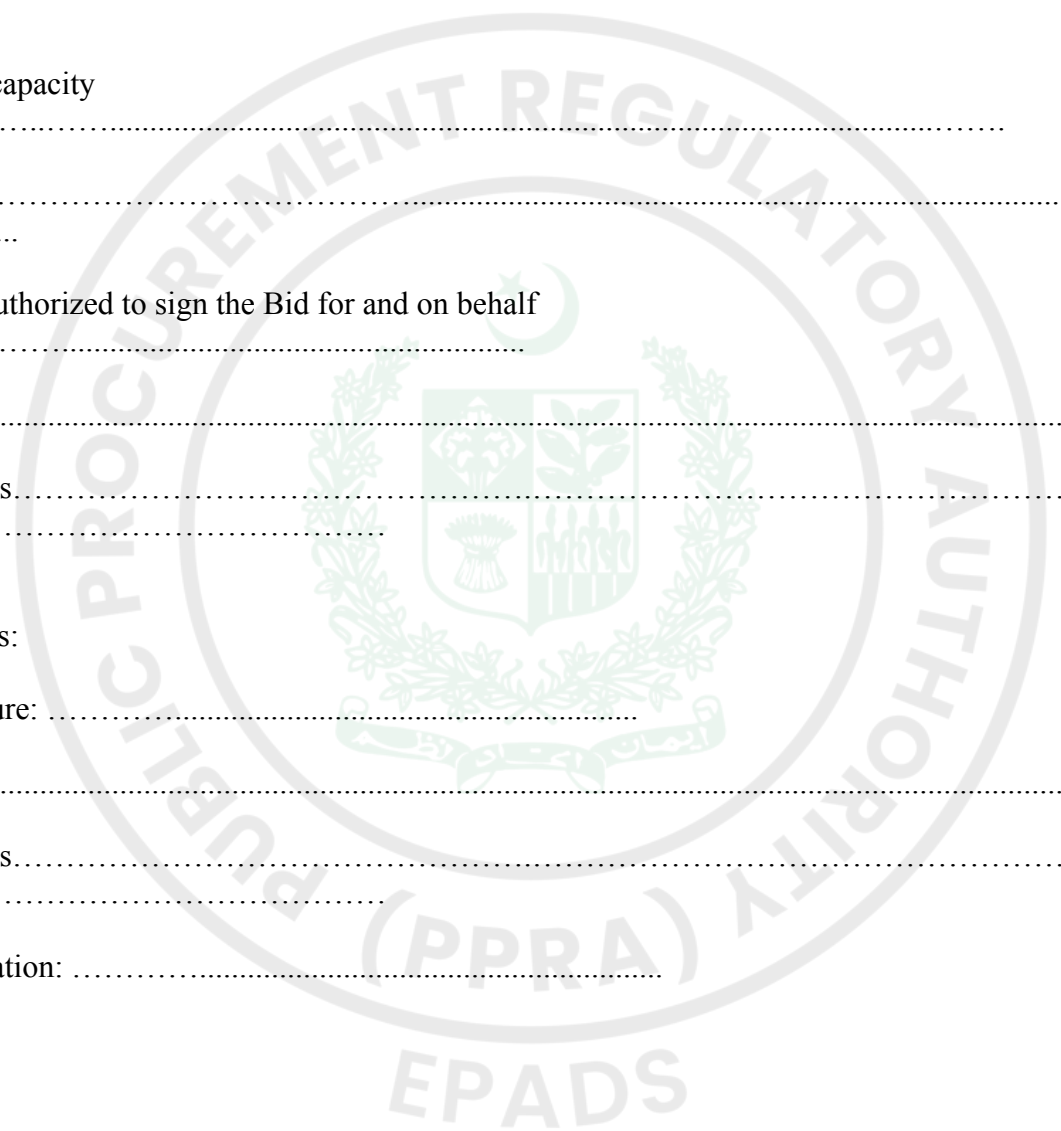

Appendix-A to Bid

SPECIAL STIPULATIONS
Clause
Conditions of Contract

1.	Law Applicable	5.1(b)	The law to be applied is the law of Islamic Republic of Pakistan.
2.	Amount of Performance Security	10.1	10% of Contract Price stated in the Letter of Acceptance.
3.	Time for Furnishing Programme	14.1	Within 30 days from the date of receipt of Letter of Acceptance.
4.	Minimum amount of third-party Insurance	23.2	Rs. 100,000 per occurrence with number of occurrences unlimited.
5.	Time for Commencement	41.1	Within 05 days from the date of receipt of the letter of acceptance.
6.	Time for Completion	43.1, 48.2	45 days from the date of signing of contract agreement or 15-days from the date of final approved shutdown by ISMO NPCC/DISCO whichever is later.
7.	a) Amount of Liquidated Damages	47.1	0.05% for each Day of delay in completion of the works subject to a maximum of 10% of contract price stated in the Letter of Acceptance.
	b) Amount of Bonus	47.3	Not Applicable
8.	Defects Liability Period	49.1	180 days from the effective date of Taking Over Certificate issued by the concerned GSO/AM formation.
09.	Percentage of Retention Money	60.2	10% of the amount of Interim Payment Certificate.
10.	Limit of Retention Money	60.2	10% of Contract Price stated in the Letter of Acceptance.
11.	Minimum amount of Interim Payment Certificates (Running Bills)	60.2	20% (at least) more than the amount of all applicable retentions and deductions on the said bill.
12.	Time of Payment from delivery of Engineer's Interim Payment Certificate to the Employer.	60.10	As per NGC Standard Payment procedure. No interest shall be paid by the Employer on delayed payments.
13.	Mobilization Advance * (Interest Free)	60.12	Not Applicable as per Bidding Documents
14.	Increase or Decrease of Cost	70.1	Not Applicable as per Bidding Documents

Appendix-B To Bid

FOREIGN CURRENCY REQUIREMENTS (Not Used)

1. The Bidder may indicate here in below his requirements of foreign currency (if any), with reference to various inputs to the Works.
2. Foreign Currency Requirement as percentage of the Bid Price excluding Provisional Sums _____%.
3. Table of Exchange Rates

Unit of Currency	Equivalent in Pak. Rupees
Australian Dollar	-----
Euro	-----
Japanese Yen	-----
U.K. Pound	-----
U.S. Dollars	-----
-----	-----
-----	-----

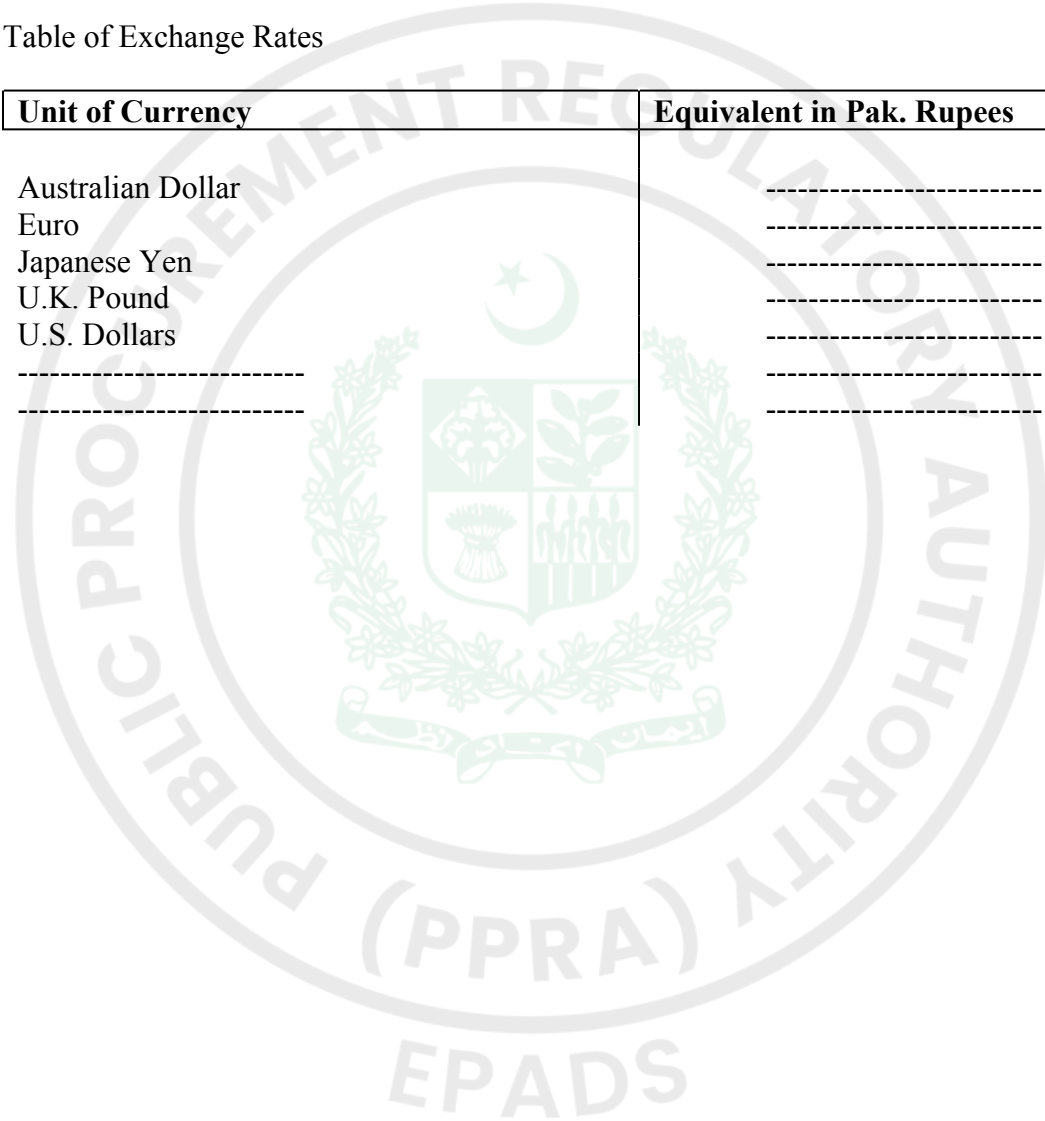

**PRICE ADJUSTMENT UNDER CLAUSE 70
OF CONDITIONS OF CONTRACT (Not Applicable)**

Price Adjustment Formula for BOQ Item V, VI (Foundations), VII & VIII (Erection & Stringing) and Item XI “Additional Works”

Prices payable to the Contractor, in accordance with the Contract, shall be subject to adjustment during performance of the Contract to reflect changes in the cost of civil works’ inputs viz. skilled & unskilled labor, reinforcing steel bars, cement, petrol and diesel, in accordance with the formula given here below, for any increase or decrease in the costs of the following:

- (a) Rate of wages of skilled or unskilled labour.
- (b) Petrol and Diesel Fuel
- (c) Cement
- (d) Reinforcing Steel Bars

No increase in the price of each of the above-mentioned components will be allowed beyond the scheduled completion period of Foundation, Installation (Erection & Stringing) works including installation services for additional works if the price increase is because of reasons attributable to the Contractor. The escalation for each component shall be according to the scheduled completion of that item provided that extension is granted.

For the avoidance of doubt, the price adjustment regarding Civil Works carried out later than the Scheduled period, shall continue to be paid at the revised rate of the constituent prevailing as on the date of its scheduled completion. The Employer will however, be entitled to any price decrease occurring during such period of delays. For each claim, the Contractor shall submit invoice from each source of supply.

The increase or decrease in the amount payable by Employer to the Contractor shall be calculated on the basis of the following formula:

For Civil Works:

$$A1 = A/100 \left(30 + 20 \frac{UL1}{UL} + 11 \frac{L1}{L} + 5 \frac{P1}{P} + 11 \frac{D1}{D} + 18 \frac{S1}{S} + 5 \frac{C1}{C} \right)$$

For Installation Works:

$$A1 = A/100 \left(30 + 26 \frac{UL1}{UL} + 14 \frac{L1}{L} + 10 \frac{P1}{P} + 20 \frac{D1}{D} \right)$$

Where

A1 = Revised amount for payment.

A = is the amount payable to the Contractor at the rates entered in Price Schedules, for the work executed after the date of change in the rates or prices of labour or materials mentioned in this section.

UL = is the basic minimum monthly wage rate for unskilled labour (PKR per month) twenty-eight (28) days prior to the date of Bid opening as stated in Table 11.12 (Intercity Prices of Construction Input Items and Labour Wages) of Monthly Statistical Bulletin for the Peshawar City, published by the Federal Bureau of Statistics (FBS), Statistics Division, Government of Pakistan.

UL1 = is the revised minimum monthly wage rate for unskilled labour (PKR per month) twenty-eight (28) days prior to the start of the execution month as stated in Table 11.12 (Intercity Prices of Construction Input Items and Labour Wages) of Monthly Statistical Bulletin for the Peshawar City, published by the FBS, Statistics Division, Government of Pakistan.

L = is the basic minimum monthly wage rate for skilled labour (mason) (PKR per month) twenty-eight (28) days prior to the date of Bid opening as stated in Table 11.12 (Intercity Prices of Construction Input Items and Labour Wages) of Monthly Statistical Bulletin for the Peshawar City, published by the FBS, Statistics Division, Government of Pakistan.

L1 = is the revised minimum monthly wage rate for skilled labour (mason) (PKR per month) twenty-eight (28) days prior to start of execution month as stated in Table 11.12 (Intercity Prices of Construction Input Items and Labour Wages) of Monthly Statistical Bulletin for the Peshawar City, published by the FBS, Statistics Division, Government of Pakistan.

P = is the basic rate of premium motor gasoline (for sale through retail outlets), maximum Ex-Depot Sales Price (PKR per liter), twenty-eight (28) days prior to the date of Bid opening as notified by Pakistan State Oil (PSO) Limited.

P1 = is the revised rate of premium motor gasoline (for sale through retail outlets), maximum Ex-Depot Sales Price (PKR per liter), twenty-eight (28) days prior to execution month as notified by Pakistan State Oil (PSO) Limited.

D = is the basic rate of high-speed diesel oil (HSD) maximum Ex-Depot Sales Price (PKR per liter), twenty-eight (28) days prior to the date of Bid opening as notified by Pakistan State Oil (PSO) Limited.

D1 = is the revised rate of high-speed diesel oil (HSD) maximum Ex-Depot Sales Price (PKR per liter), twenty-eight (28) days prior to execution month as notified by Pakistan State Oil (PSO) Limited.

S = is the basic rate of reinforcing steel ½ inch round MS bars (PKR per metric ton), twenty-eight (28) days prior to the date of Bid opening, as stated in Table 11.10 (Intercity Wholesale Prices of Selected Commodities) Monthly Statistical Bulletin for the Peshawar City, published by the FBS, Statistics Division, Government of Pakistan.

- S1 = is the revised rate of reinforcing steel $\frac{1}{2}$ inch round MS bars (PKR per metric ton), twenty-eight (28) days prior to the start of execution month, as stated in Table 11.10 (Intercity Wholesale Prices of Selected Commodities) of Monthly Statistical Bulletin for the Peshawar City, published by the FBS, Statistics Division, Government of Pakistan.
- C = is the basic rate of Ordinary Portland Cement (PKR per bag), twenty-eight (28) days prior to the date of Bid opening as stated in Table 11.12 (Intercity Prices of Construction Input Items and Labour Wages) of Monthly Statistical Bulletin for the Peshawar City, published by the FBS, Statistics Division, Government of Pakistan.
- C1 = is the revised rate of Ordinary Portland Cement (PKR per bag), twenty-eight (28) days prior to the start of execution month as stated in Table 11.12 (Intercity Prices of Construction Input Items and Labour Wages) of Monthly Statistical Bulletin for the Peshawar City, published by the FBS, Statistics Division, Government of Pakistan.
- 30 = is the fixed percentage coefficient.

In determining the amount of any increase or decrease to the Contract Price pursuant to this section, no account shall be taken of any fluctuation as a result of Government Orders or otherwise in the cost of benefits i.e., bonus, gratuity, education, group insurance, paid holidays, casual leaves, workmen compensation etc. Any increase or decrease in the price of materials which have not been used on the project during that month shall not be considered in the adjustment of the Contract Price, and the ratio will be taken as one (1). If at any time the current indices are not available, provisional indices as determined by the Project Manager will be used subject to subsequent correction of the amounts paid to the Contractor when the current indices become available.

The value of any revised rates or prices shall be supported by documentary evidences to the satisfaction of the Project Manager and the Employer.

No price adjustment shall be payable on the portion of the Contract Price paid to the Contractor as an Advance Payment.

Price Escalation/ Adjustment shall be applied only if the resulting increase or decrease is more than two percent (2%) of the amount of respective payment invoice calculated at the rates entered in the schedule of prices.

Appendix-D to Bid**BILL OF QUANTITIES****A. Preamble****General**

1. The Schedule of Quantities shall be read in conjunction with the Conditions of Contract, Specifications and Drawings. The Schedules do not generally give a full description of the Services to be performed under each item. Bidders shall be deemed to have read the Technical Specifications and other sections of the Bidding Documents and reviewed the Drawings to ascertain the full scope of the requirements included in each item prior to filling in the rates and prices. The entered rates and prices shall be deemed to include for the full scope as aforesaid, including overheads and profit.
2. If bidders are unclear or uncertain as to the scope of any item, they shall seek clarification in accordance with IB 8 prior to submitting their bids.
3. The quantities given in the Schedule of Quantities are estimated and provisional, and are given to provide a common basis for bidding. The basis of payment will be the actual quantities of work executed and measured by the Contractor and verified by the Engineer and valued at the rates and prices entered in the priced Schedule of Quantities, where applicable, and otherwise at such rates and prices as the Engineer may fix in accordance with provisions of the Contract.
4. The rates and prices entered in the priced Schedule of Quantities shall, except insofar as it is otherwise provided under the Contract include all costs of Contractor's plant, labor, supervision, materials, execution, insurance, profit, taxes and duties, together with all general risks, liabilities and obligations set out or implied in the Contract. Furthermore, all duties, taxes and other levies payable by the Contractor under the Contract, or for any other cause, as on the date 28 days prior to deadline for submission of Bids, shall be included in the rates and prices and the total Bid Price submitted by the Bidder.
5. A rate or price shall be entered against each item in the priced Schedule of Quantities, whether quantities are stated or not. The cost of items against which the Contractor will have failed to enter a rate or price shall be deemed to be covered by other rates and prices entered in the Schedule of Quantities.
6. The whole cost of complying with the provisions of the Contract shall be included in the items provided in the priced Schedule of Quantities, and where no items are provided, the cost shall be deemed to be distributed among the rates and prices entered for the related items of the Works.
7. General directions and description of work and materials are not necessarily repeated nor summarized in the Schedule of Quantities. References to the relevant sections of the Bidding Documents shall be made before entering prices against each item in the priced Schedule of Quantities.

8. Contractor shall be responsible for arrangement of all consumable materials for execution of works within the prices quoted in Price schedules/BoQ.
9. Provisional sums if included and so designated in the Schedule of Quantities shall be expended in whole or in part at the direction and discretion of the Engineer in accordance with Conditions of Contract.
10. As this a measurement type contract so quantities may increase or decrease and / or their types may vary resultantly the contract price may change. The Engineer is authorized to measure such work and accordingly approve the invoices. The Employer shall not stop payment merely it is beyond the price of the contract. However, such changes shall immediately be conveyed to Project Management Office (PMO) NGC / Change Control Board/ Steering Committee. In case any irregularity is found, the Employer shall reserve the right to withhold the payments and recover its loss from any amount due or to be due to the contractor besides other remedial measures.

Units & Abbreviations

11. Units of measurement, symbols and abbreviations expressed in the Bidding Documents shall comply with the System International Unites (SI Units).
12. The following abbreviations shall be used in the Price Schedules:

Abbreviation

Pakistani Rupees	PKR
Number	No.
Kilometer	km
Kilogram	kg
Cubic Meter	Cu.m
Provisional Sums	PS
Percent	%
Quantity	Qty

Pricing

13. Prices shall be filled in indelible ink, and any alterations necessary due to errors, etc., shall be initialed by the Bidder.
14. For each item, bidders shall complete each appropriate column in the respective Schedules, giving the price breakdown as indicated in the Schedules. Prices given in the Schedules against each item shall be for the scope covered by that item as detailed in Section 6 (Employer's Requirements), Technical Specifications, Drawings or elsewhere in the Bidding Documents.

15. The TOTAL for each Schedule and TOTAL of the Grand Summary shall be deemed to be the total price for executing and completing the Facilities in accordance with the Contract, whether or not each individual item has been priced.
16. When requested by the Employer for the purposes of making payments or part payments, valuing variations or evaluating claims, or for such other purposes as the Employer may reasonably require, the Contractor shall provide the Employer with a breakdown of any composite or lump sum items included in the Schedules.
17. Except as otherwise expressly provided under the Conditions of Contract, the unit rates and lump sum amounts entered in the Price Schedules will be the rates at which the Contractor will be paid, and shall be deemed to include for the full scope and all costs incurred by the Contractor in the performance of the Facilities, the provision of services including his overheads, income tax, super tax, other indirect costs, profits and costs of accepting the general risks, liabilities and obligations set forth or implied in the Contract, except for such costs which are specified as reimbursable under the Contract.
18. Arithmetic errors will be corrected by the Employer as per ITB 31.
19. Price of any other item not specifically covered in the Price Schedules but is required for the completion, commissioning and operation of the overhead transmission line shall be deemed to be included in the Schedule of Quantities.
20. The Contractor will be responsible for arrangement of all necessary security measures for protection of Plants, equipment, personnel and other assets of Contractor or Employer at site until taking over of works by the Employer.
21. The Contractor shall take all the safeguards at site for safety/security of men, material and machinery at his own responsibility and cost.

SPECIAL NOTES FOR MATTERS RELATED TO TRANSPORTATION OF MATERIALS/GOODS

- (1) *Transportation of necessary material shall be responsibility of the Contractor. In case transportation is from a location different then designated in the Contract, the Engineer shall determine the rates pursuant to Clause 52.1.*
- (2) *The Transportation of spare/serviceable material from site to any designated NGC warehouse is responsibility of the Contractor. After issuance of material re-conciliation report, the Engineer will coordinate allocation and transportation of this material to the designated warehouse.*
- (3) *Civil Works Contractor will be responsible for civil works, installation, testing & commissioning on single responsibility basis.*
- (4) *The material will be allocated by T/L Design (NGC). Once the material is received by the contractor, its safe handling and any shortage thereof shall be responsibility of the contractor.*

Bill of Quantities for Construction and Completion of Civil Works, Erection, Stringing, Testing & Commissioning for CONVERSION OF TOWER NOS. 42 & 43 OF 220KV D/C TWIN BUNDLE T/LINE FROM SHEIKHUPURA RAVI (1 & 2) FROM SUSPENSION TYPE TO TENSION TYPE

BILL OF QUANTITIES

Item No.	Description of Work	Unit of Measurement	Quantity	Unit Rate Civil/ Installation	Total	Provincial Sales Tax	Total Price Inclusive of Provincial Sales Tax
				(PKR)	(PKR)	(PKR)	(PKR)
1	2	3	4	5	6 = 4x5	7	8 = 6+7
I	Cost of Check Survey, Clearing ROW & Mobilization						
i	Clearing Right of Way	Job	1		-	-	-
ii	Mobilization and Demobilization	Job	2		-	-	-
iii	Check Survey including pegging out and layout of tower locations, spotting / stalking of towers, Tower Spotting adjustment etc.	Job	1		-	-	-
II	Pile Foundations						
1	Reinforced concrete pile pier foundations (cast in situ installation) complete with supply of materials etc. using Sulphate Resisting Cement (SRC) conforming to ASTM C-150 including installation of tower grounding for all tower types:						
	(a) Reinforced concrete pile caps with chimney grade and stub setting as per tower type and drawing No. PDW/TC-956 Single Pile Per Footing	Nos. (02 Foundations)	8		-	-	-
	(b) Reinforced concrete single pile per footing 1220 mm dia. as per drawing No. PDW/TC-956 Single Pile Per Footing						
	(i) Pile shaft upto depth of 20 m	Lin.mtr	160		-	-	-
III	Steel Tower Erection & Dismantling						
1	Transport & install 220kV towers types 'EG' Make B+0+8 , including leg extensions, stubs etc as the case may be, in accordance with requirements of tender documents and complete in all respect along with accessories including U-bolts/V-shackles, aerial markers, number plates, danger signs, phase plates and anti-climbing devices along with barbed wire etc.	Per Tower	2		-	-	-
2	Welding of erected tower bolts and nuts after final inspection up to height of 8.0 m from top of foundation chimney as per specification.	No. of Towers	2		-	-	-
3	Dismantling of Existing 02 Nos. EA Type Towers Make B+0+8 complete in all respects and its transport to the designated NGC store/Warehouse and proper accountal	Per Tower	2		-	-	-
IV	Stringing of OPGW & Conductors						
1	Transport & install ACSR"Rail" Conductor for Twin conductor configuration, polymer insulator installation alongwith complete hardware, accessories & dampers etc. complete in all respects as per specifications & approved drawings	Lumpsum	1		-	-	-
2	Transport & Install OPGW/Sheild wire including installation of drop down lengths for joint boxes at the towers along with allied hardware material including hardware assemblies, joint boxes accessories, dampers etc complete in all respects as per specifications &	Lumpsum	1		-	-	-
V	Testing and Commissioning of T/Lines						
		Lumpsum	1		-	-	-
VI	Additional Work						
	Bitumen coating for footing of towers	Per Tower	1		-	-	-
	Sub Total From I to VI				-	-	-
	Grand Total with PST(I to VI)						
Notes:							
1	The quantities given in Bill of Quantities are tentative/estimated.						
2	The Contractor shall be paid for the actual quantities installed in accordance with the unit rates given in the Bill of Quantities.						
3	Price of any other item specifically not covered in the Bill of Quantities but is required for the completion, testing & commissioning and operation of the overhead line shall be deemed to be included in the Bill of Quantities.						
4	If the Bidder failed to enter the rate of PST, the same shall be deemed to be included in unit price of the items. If the bidder explicitly mentions that the price is without PST, the bid shall be rejected.						
5	Contractor has to shift the installation material from the NGC designated warehouse/store to construction sites.						
6	Unit "Foundation" means foundations of four (04) legs of the Tower and Per Tower Means Complete tower with all leg and Body Extensions.						
7	The quoted unit rate should include charges for insurance and transportation (including loading, unloading and stacking etc.) of all the above Goods/materials from NTDC Gatti/Multan/Jamshoro/NKLP Warehouse Site/Contractor's Store.						
8	The Contractor shall take all safeguards at site for safety/security of men, material and machinery at his own responsibility and cost.						
9	The quantites has taken from the approved profile by the office of C.E T/L Design vide No.CE/TL/NGC/MTL-/L-133/427-30 dated 11-02-2026.						

**Appendix-E to Bid
Sheet 1 of 2**

PROPOSED CONSTRUCTION SCHEDULE

Pursuant to Sub-Clause 43.1 of the General Conditions of Contract, the Works shall be completed on or before the date stated in Appendix-A to Bid. The Bidder shall provide as Appendix-E to Bid, the Construction Schedule in the bar chart (CPM, PERT or any other to be specified herein) showing the sequence of work items and the period of time during which he proposes to complete the Works including the activities like mobilization, survey for staking, Civil Works (Foundations), Erection of Towers, Stringing, OPGW Splicing, testing and commissioning of Works to be executed under the Contract. It shall include but not limited to the following:

Sr. No.	Description of Work	Period in months from the effective date of contract
1.	Establishment of site office	
2.	Erection a) Commencement b) Completion	
3.	Testing & Pre-commissioning a) Commencement b) Completion	
4.	Commissioning	

To provide the accumulative effective of the activities per month, the bidder shall also provide the graph/ chart as following:

Sr. No.	Description	Days (Months)					
		05	20	30	45	-----	
1.	Signing of contract						
2.	Commencement						
3.	Mobilization						
4.	Check Survey						
5.	Civil Works (Foundations)						
6.	Erection of Towers						
7.	Stringing						
8.	Testing & commissioning						

The proposed program of Works shall base on the Schedule of Implementation as per Bidding Documents.

**Appendix-E to Bid
Sheet 2 of 2**

Note: The bidder shall also indicate the construction crews employed to achieve the completion target for the following:

Type of Crews	No. of Crews employed	Expected Progress/ month/ crew*
Piling Crew		
Erection Crew		
Stringing Crew		

*Mention the required time per tower of a crew to complete a certain activity e.g., foundation etc.

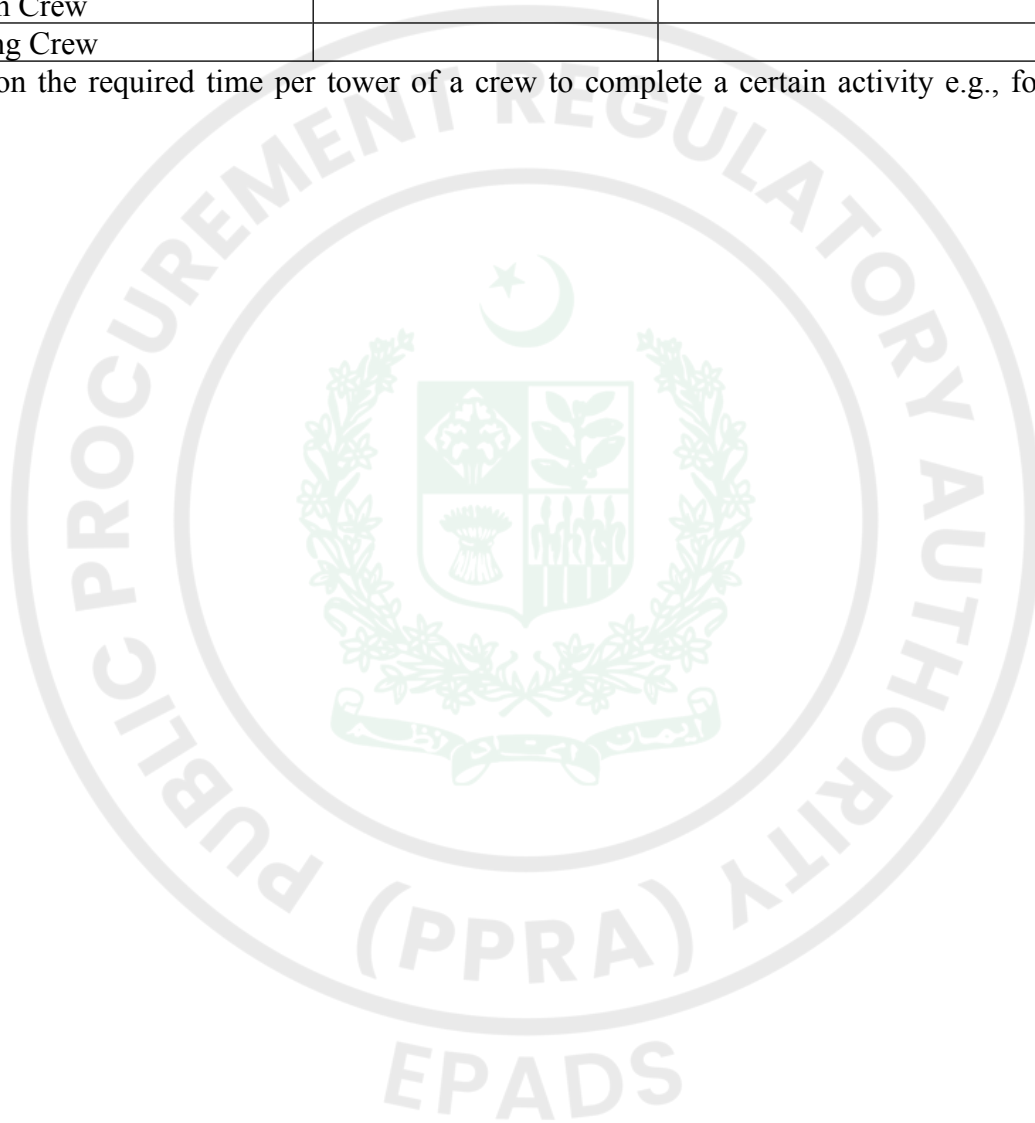

Appendix-F to Bid**METHOD OF PERFORMING THE WORK**

The Bidder is required to submit a narrative outlining the method of performing the Work. The narrative should indicate in detail and include but not be limited to:

1. Organization Chart indicating head office and field office personnel involved in management and supervision, engineering, equipment maintenance and purchasing.
2. Mobilization in Pakistan, the type of facilities including personnel accommodation, office accommodation, provision for maintenance and for storage, communications, security and other services to be used.
3. The method of executing the Works, the procedures for installation of equipment and machinery and transportation of equipment and materials to the site.
4. Quality control / Quality assurance measures to be adopted including procedures to be followed for carrying out all tests required under specifications.
5. Detailed Work Plan depicting the detail of activity (atleast level-04) and the expectation of cash flows.

Appendix-G to Bid**Personnel****Form PER – 1: Proposed Personnel**

Bidders should provide the names of suitably qualified personnel to meet the specified requirements for each of the positions listed in Section 2. The data on their experience should be supplied using the Form below for each candidate.

1.	Title of position
	Name
2.	Title of position*
	Name
3.	Title of position*
	Name
4.	Title of position*
	Name
5.	Title of position*
	Name

Form PER – 2: Resume of Proposed Personnel

The Bidder shall provide all the information requested below. Fields with asterisk (*) shall be used for evaluation.

Position*		
Personnel information	Name	Date of birth
	Professional qualifications	
Present employment	Name of employer	
	Address of employer	
	Telephone	Contact (manager / personnel officer)
	Fax	E-mail
	Job title	Years with present employer

Summarize professional experience in reverse chronological order. Indicate particular technical and managerial experience relevant to the project.

From*	To*	Company, Project, Position and Relevant Technical and Management Experience*

Note: *The Engineer while making his determination for extension of time under this clause will take due consideration of the (committed) resources to be deployed by the Contractor at site in accordance with this appendix*

Appendix-H to Bid

EQUIPMENT

Form EQ – 1: List of Major Equipment – Related Items

The Bidder will provide on Sheet 2 of this Appendix a list of all major equipment and related items, under separate heading for items owned, to be purchased or to be arranged on lease by him to carry out the Works. The information shall include make, type, capacity, and anticipated period of utilization for all equipment which shall be in sufficient detail to demonstrate fully that the equipment will meet all requirements of the Specifications. The list of major equipment for construction works of the project should be addressed under the following categories:

- a) Right of way
- b) Survey for staking
- c) Pile work/Pile Caps
- d) Erection works
- e) Conductor & OPGW stringing
- f) Any other

Note: *The Engineer while making his determination for extension of time under this clause will take due consideration of the (committed) resources to be deployed by the Contractor at site in accordance with this appendix*

Form EQ – 2: List of Major Equipment

Owned Purchased or Leased	Description of Unit (Make, Model, Year)	Capacity HP Rating	Condition	Present Location or Source	Date of Delivery at Site	Period of Work on Project
1	2	3	4	5	6	7
A) Right of way a. Owned b. To be Purchased c. To be arranged on Lease						
B) Survey for staking a. Owned b. To be Purchased c. To be arranged on Lease						
C) Pile work/Pile Caps with Beams a. Owned b. To be Purchased c. To be arranged on Lease						
D) Erection works a. Owned b. To be Purchased c. To be arranged on Lease						
E) Conductor &OPGW stringing a. Owned b. To be Purchased c. To be arranged on Lease						
F) Dismantling Works a. Owned b. To be Purchased c. To be arranged on Lease						

Appendix-I to Bid**CONSTRUCTION CAMP AND HOUSING FACILITIES**

The Contractor in accordance with Clause 34 of the Conditions of Contract shall provide description of his construction camp's facilities and staff housing requirements.

The Contractor shall be responsible for pumps, electrical power, water and electrical distribution systems, and sewerage system including all fittings, pipes and other items necessary for servicing the Contractor's construction camp.

The Bidder shall list or explain his plans for providing these facilities for the service of the Contract as follows:

1. Site Preparation (clearing, land preparation, etc.).
2. Provision of Services.
 - a) Power (expected power load, etc.).
 - b) Water (required amount and system proposed).
 - c) Sanitation (sewage disposal system, etc.).
3. Construction of Facilities
 - a) Contractor's Office. Workshop and Work Areas (areas required and proposed layout, type of construction of buildings, etc.).
 - b) Warehouses and Storage Areas (area required, type of construction and layout).
 - c) Housing and Staff Facilities (Plans for housing for proposed staff, layout, type of construction, etc.).
4. Construction Equipment Assembly and Preparation (detailed plans for carrying out this activity).
5. Other Items Proposed (Security services, etc.).
6. Detail of testing Lab with testing equipment etc.

Appendix-J to Bid

**ORGANIZATION CHART
FOR THE
SUPERVISORY STAFF AND LABOR**



Appendix-K to Bid**LIST OF SUBCONTRACTORS**

I/We intend to subcontract the following parts of the Work to subcontractors. In my/our opinion, the subcontractors named hereunder are reliable and competent to perform that part of the work for which each is listed.

Enclosed are documentation outlining experience of subcontractors, the curriculum vitae and experience of their key personnel who will be assigned to the Contract, equipment to be supplied by them, size, location and type of contracts carried out in the past.

Part of Works (Give Details)	Subcontractor (With Complete Address)
1	2

Note:- The subcontractor will not be replaced without prior approval of the Employer.

Appendix-L to Bid

**SOURCES OF MATERIAL
LIST OF MATERIALS LIKE CEMENT, REINFORCING STEEL**

The bidder shall list in this Schedule the names of materials forming part of tower foundations such as cement, reinforcing steel which he intends to procure in connection with this Contract along with the names and complete addresses of the sources.

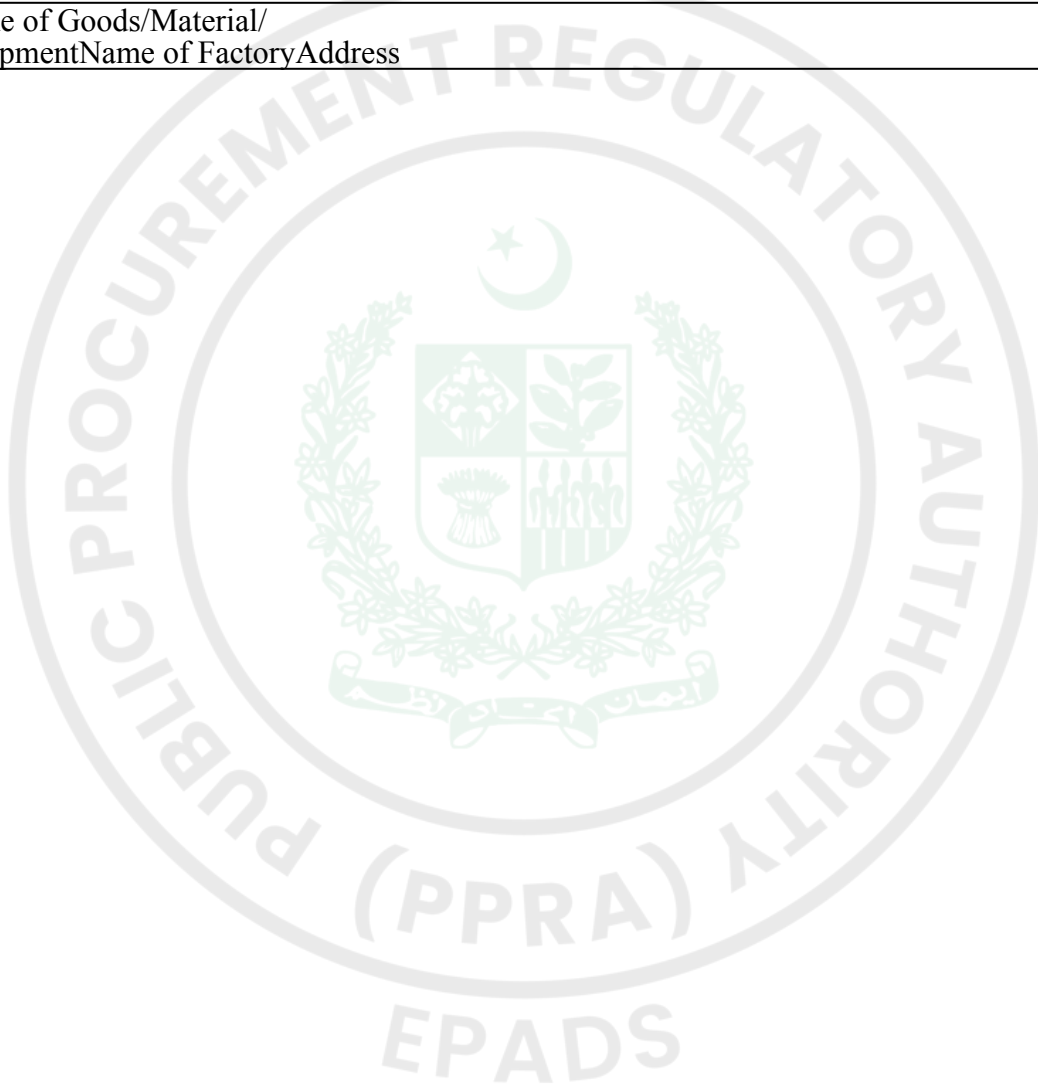
Name of Goods/Material/ EquipmentName of FactoryAddress

Use additional sheets if required.

Appendix-M to Bid**ESTIMATED PROGRESS PAYMENTS**

Bidder's estimate of the value of work which would be executed by him during each of the periods stated below, based on his Program of Works and the Rates in the Schedule of Prices,

Period	Amounts (Rs.)
Ist Month	
2 nd Month	
Total Bid Price	

Initials of Signatory to Bid:

Appendix-N to Bid**DEVIATIONS****Form D1-Deviations from Contractual Conditions**

Deviations if any, which the bidder has taken to the Contractual Conditions in preparation of his bid, must be listed below.

Sr. No.	Clause No. /Section No.	Deviations
---------	-------------------------	------------

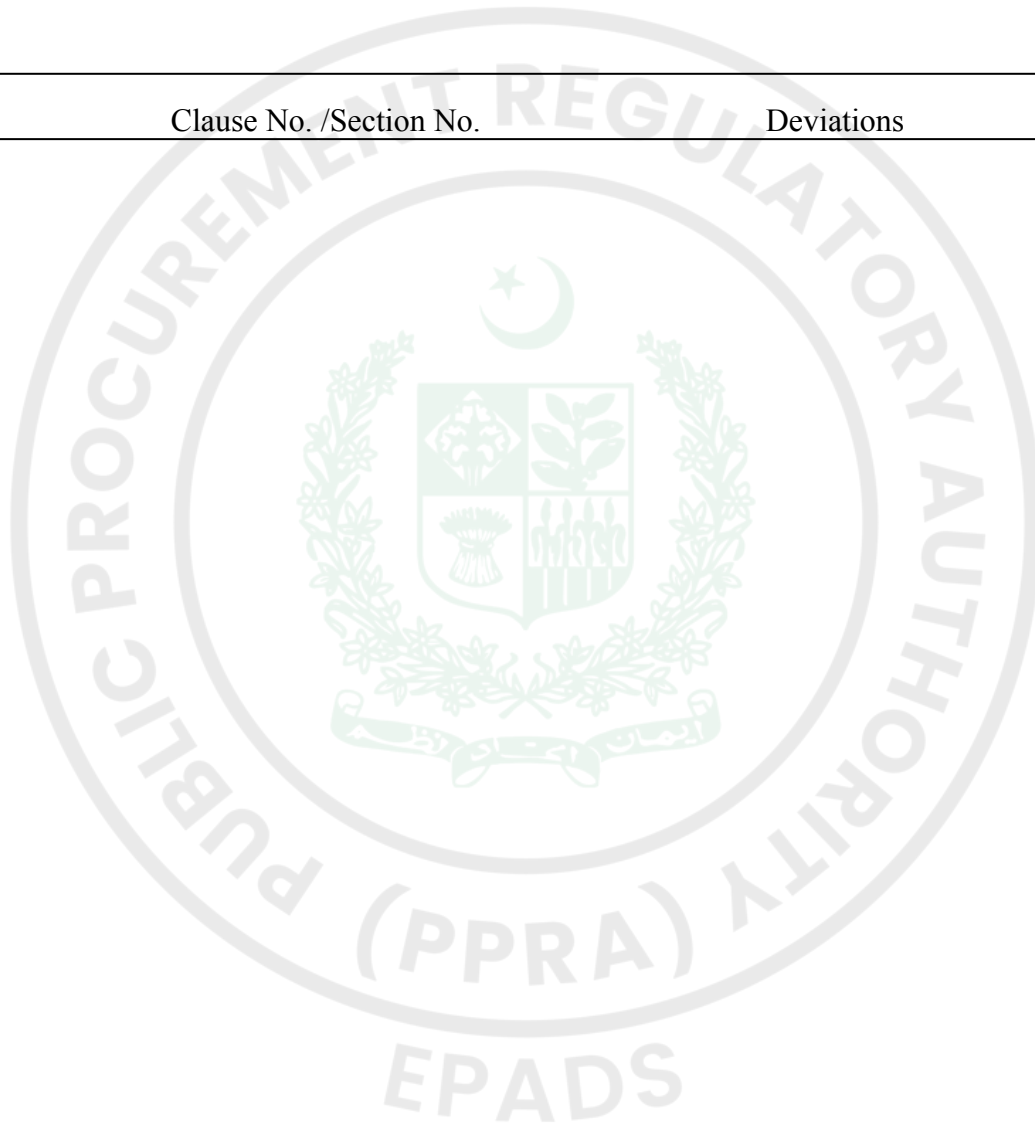

Note: Attach additional sheets, if necessary.

Form D2-Deviations from Technical Conditions

Deviations if any, which the bidder has taken to the Technical Provisions in preparation of his bid, must be listed below.

Sr. No.	Clause No. /Section No.	Deviations
---------	-------------------------	------------



Note: Attach additional sheets, if necessary.

Appendix-O to Bid**INTEGRITY PACT****DECLARATION OF FEES, COMMISSION AND BROKERAGE ETC.
PAYABLE BY THE SUPPLIERS OF GOODS, SERVICES & WORKS
IN CONTRACTS WORTH RS. 10.00 MILLION OR MORE**

Contract No. _____ Dated _____

Contract Value: _____

Contract Title: _____

[Name of Supplier] hereby declares that it has not obtained or induced the procurement of any contract, right, interest, privilege or other obligation or benefit from Government of Pakistan (GoP) or any administrative subdivision or agency thereof or any other entity owned or controlled by GoP through any corrupt business practice.

Without limiting the generality of the foregoing, [name of Supplier] represents and warrants that it has fully declared the brokerage, commission, fees etc. paid or payable to anyone and not given or agreed to give and shall not give or agree to give to anyone within or outside Pakistan either directly or indirectly through any natural or juridical person, including its affiliate, agent, associate, broker, consultant, director, promoter, shareholder, sponsor or subsidiary, any commission, gratification, bribe, finder's fee or kickback, whether described as consultation fee or otherwise, with the object of obtaining or inducing the procurement of a contract, right, interest, privilege or other obligation or benefit in whatsoever form from GoP, except that which has been expressly declared pursuant hereto.

[name of Supplier] certifies that it has made and will make full disclosure of all agreements and arrangements with all persons in respect of or related to the transaction with GoP and has not taken any action or will not take any action to circumvent the above declaration, representation or warranty.

[name of Supplier] accepts full responsibility and strict liability for making any false declaration, not making full disclosure, misrepresenting facts or taking any action likely to defeat the purpose of this declaration, representation and warranty. It agrees that any contract, right, interest, privilege or other obligation or benefit obtained or procured as aforesaid shall, without prejudice to any other rights and remedies available to GoP under any law, contract or other instrument, be voidable at the option of GoP.

Notwithstanding any rights and remedies exercised by GoP in this regard, [name of Supplier] agrees to indemnify GoP for any loss or damage incurred by it on account of its corrupt business practices and further pay compensation to GoP in an amount equivalent to ten times the sum of any commission, gratification, bribe, finder's fee or kickback given by [name of Supplier] as aforesaid for the purpose of obtaining or inducing the procurement of any contract, right, interest, privilege or other obligation or benefit in whatsoever form from GoP.

Name of Buyer:

Signature:

[Seal]

Name of Seller/Supplier:

Signature:

[Seal]

BIDDER'S QUALIFICATION FORMS

QF-1	General Information
QF-2	Construction Experience
QF-3	Performance Certificate
QF-4	Current Contract Commitments
QF-5	Financial Data
QF-6	Annual Turnover Data
QF-7	Financial Resources
QF-8	Bank Certificate
QF-9	Pending Litigation

Note: -

1. These forms shall be filled up and furnished by the Bidder and its Joint Venture partner(s), if any.
2. If necessary, additional sheets may be added to the forms. Each page of each form should be clearly marked in the right top corner as follows: Form QF1, page 1; Form QF1, page 2, etc.
3. Some forms will require attachments. Such attachments should be clearly marked as follows: Attachment 1 to Form QF1, Attachment 2 to Form QF1, etc.

Form QF-1: General Information

Bidder and its Joint Venture Partner(s) and/or Subcontractors are requested to complete the information in this form. Nationally information of Bidders should also be provided.

1.	Name of Bidder	
2.	Head office address	
3.	Local office address (if any)	
4.	Telephone	Contract
5.	Facsimile	e-mail
6.	Place of incorporation/registration	Year of incorporation/registration
7.	Main lines of Business	
	1.	Since:
	2.	Since:
	3.	Since:
	4.	Since:

Note:

Copies of following credentials shall be attached:

- (a) Copy of incorporation/registration certificate
- (b) Organization chart
- (c) PEC registration certificate in the appropriate category

Signature and Seal of Bidder:

Form QF-2: Construction Experience

Note: To be filled in accordance with criteria described in clause IB3.1 (b) Section-II of the bidding documents

(For a period of Last 10 Years)

Name of the Project:

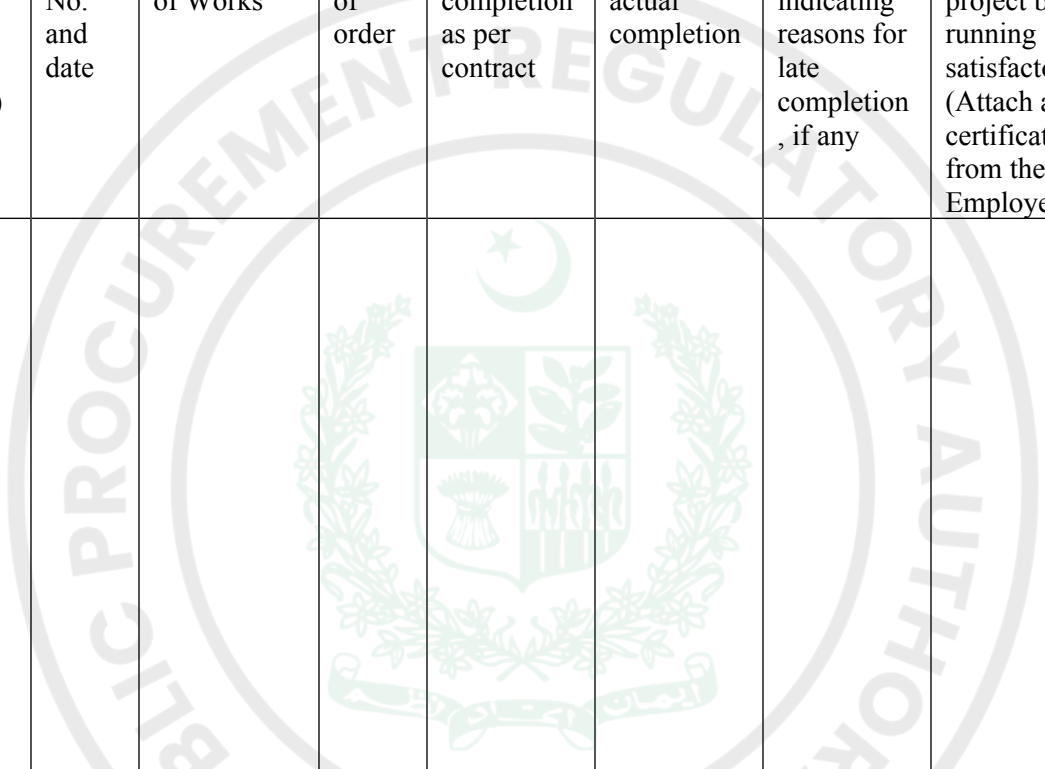
Order Placed by (full address of Employer)	Order No. and date	Description of Works	Value of order	Date of completion as per contract	Date of actual completion	Remarks indicating reasons for late completion , if any	Has the project been running satisfactorily? (Attach a certificate from the Employer)	Contact person along with Telephone No., Fax No. and email address
								

Signature and Seal of the Bidder.....

Place:

Date:

Form QF-3: Performance Certificate

It is to certify that M/s. _____ has conducted the following works against mentioned project.

Sr.No.	Contract No. & Date	Designation & address of order placing authority/User	Name of Project	Description of Works	Date of Commencement	Date of Completion

The above services/ works have been performed against our Project and their performance is found satisfactory.

Date of issuing _____

Signature of issuing authority with seal
Name and designation of issuing authority
Address along with Email, Phone No. and
Fax of issuing authority

Note:

- i. Those bidders who have provided services to NGC, shall furnish the details of such works in the above Performa which shall be signed by their authorized signatory along with seal; and Certificate from the Employer is not required in this respect.
- ii. **In case the performance certificate is not verifiable through the given contact address and email, the bid may be rejected.**

Form QF-4: Current Contract Commitments

Bidders should provide information on their current commitments on all contracts that have been awarded, or for which a letter of intent or acceptance has been received, or for contracts approaching completion, but for which an unqualified, full completion certificate has yet to be issued.

In case of a Joint Venture, each Joint Venture Partner must fill out this form separately and provide the Joint Venture Partner's name below:

Joint Venture Partner: _____

Joint Venture Partner: _____

Current Contract Commitments

No.	Name of Contract	Employer's Contact (Address, Tel, Fax)	Total Contract Value	Contract Completion Date	Outstanding Contract Value (X) ^a	Remaining Contract Period in months (Y) ^b	Monthly Financial Resources Requirement (X / Y)
1							
2							
3							
4							
Total Monthly Financial Requirement for Current Contract Commitments							\$

a Remaining outstanding contract values to be calculated from 28 days prior to the bid submission deadline (\$ equivalent based on the foreign exchange rate as of the same date).

b Remaining contract period to be calculated from 28 days prior to bid submission deadline.

c The monthly commitments calculated from above table will be multiplied with a factor (proposed "3") to calculate the total commitments for 03 months.

Signature & Seal of the bidder:

Form QF-5: Financial Data

Financial Data for Previous Five (05) Years					
Particular					
Total Assets					
Total Liabilities					
Net Worth					
Current Assets					
Current Liabilities					
Information from Income Statement					
Total Revenues					
Profits Before Taxes					
Profits After Taxes					
Attached are copies of financial statements (balance sheets including all related notes, and income statements) for the last five years, as indicated above, complying with the following conditions.					
•	All such documents reflect the financial situation of the Bidder and not sister or parent companies.				
•	Historic financial statements must be audited by a certified accountant.				
•	Historic Financial statements must be complete, including all notes to the financial statements.				
•	Historic financial statements must correspond to accounting periods already completed and audited (no statements for partial periods shall be requested or accepted).				

Signature and Seal of the bidder:

Form QF-6: Annual Turnover Data

Name of Bidder/Joint Venture Partner:

Bidder and its Joint Venture Partner(s) are requested to complete the information in this form separately. The information supplied should be the annual turnover of the Bidder, in terms of the amounts billed to clients for each year for work in progress or completed. In case of a joint venture, a copy of the Joint Venture Agreement must be attached. The average Annual Turnover may include turnover of affiliates and subsidiaries to the extent of shareholding percentage of bidding company provided the turnover is accrued from similar business activity as the bidding company.

Use a separate sheet for bidder and its Joint Venture partner(s).

Annual turnover data for the following last three (03) fiscal years			
Year	Amount Currency	Exchange Rate	Equivalent Amount (in the currency of Bid)
2023			
2024			
2025			
Average Annual Turnover			

Signature and Seal of Bidder:

Form QF-7: Financial Resources

Specify proposed sources of financing, such as liquid assets, lines of credit, and other financial means, available to meet Bidder's financial requirements for

- (a) its current contract commitments calculated on three (03) months basis, and
- (b) the subject contract.

In case of a Joint Venture, each Joint Venture Partner must fill out this form separately and provide the Joint Venture Partner's name below:

Joint Venture Partner: _____

Financial Resources		
Sr. No.	Source of Financing	Amount
1.	Liquid Assets	
2.	Credit Line*	
3.	Other Financial Resources	
	Total Available Financial Resources	

- To be substantiated by a letter from the bank issuing the line of credit.

[Note: No credit line after opening of bids shall be acceptable. Any withdrawal of the credit lines from the bidder's creditors during validity of bid shall be considered a withdrawal of bid]

Signature and Seal of Bidder:

Form QF-8: Bank Certificate

This is to certify that M/s..... is a reputed company with a good financial standing.

If the contract for the work, namely..... is awarded to the above firm, we shall be able to provide overdraft/credit facilities to the extent of Rs..... to meet their working capital requirements for executing the above contract.

Signature of Senior Bank Manager: _____
 Name of the Senior Bank Manager: _____
 Address of the Bank: _____

Stamp of the Bank

Note: Certificate should be on the letter head of the bank.

▪ **Change the text as follows for Joint Venture:**

This is to certify that M/s..... who has formed a JV with M/s..... and M/s..... for participating in this bid, is a reputed company with a good financial standing.

If the contract for the work, namely..... is awarded to the above Joint Venture, we shall be able to provide overdraft/credit facilities to the extent of Rs..... to M/s..... to meet the working capital requirements for executing the above contract.

[This should be given by each of the JV members in proportion to their financial participation.]

Form QF-9: Pending Litigation

Each Bidder or member of a JV must fill in this form

Pending Litigation					
Year	Name of Other Party(s)	Matter of Dispute	Litigation where (Court/ arbitration)	Amount involved	Value of pending claim as a %age of net worth

Signature and Seal of the bidder:

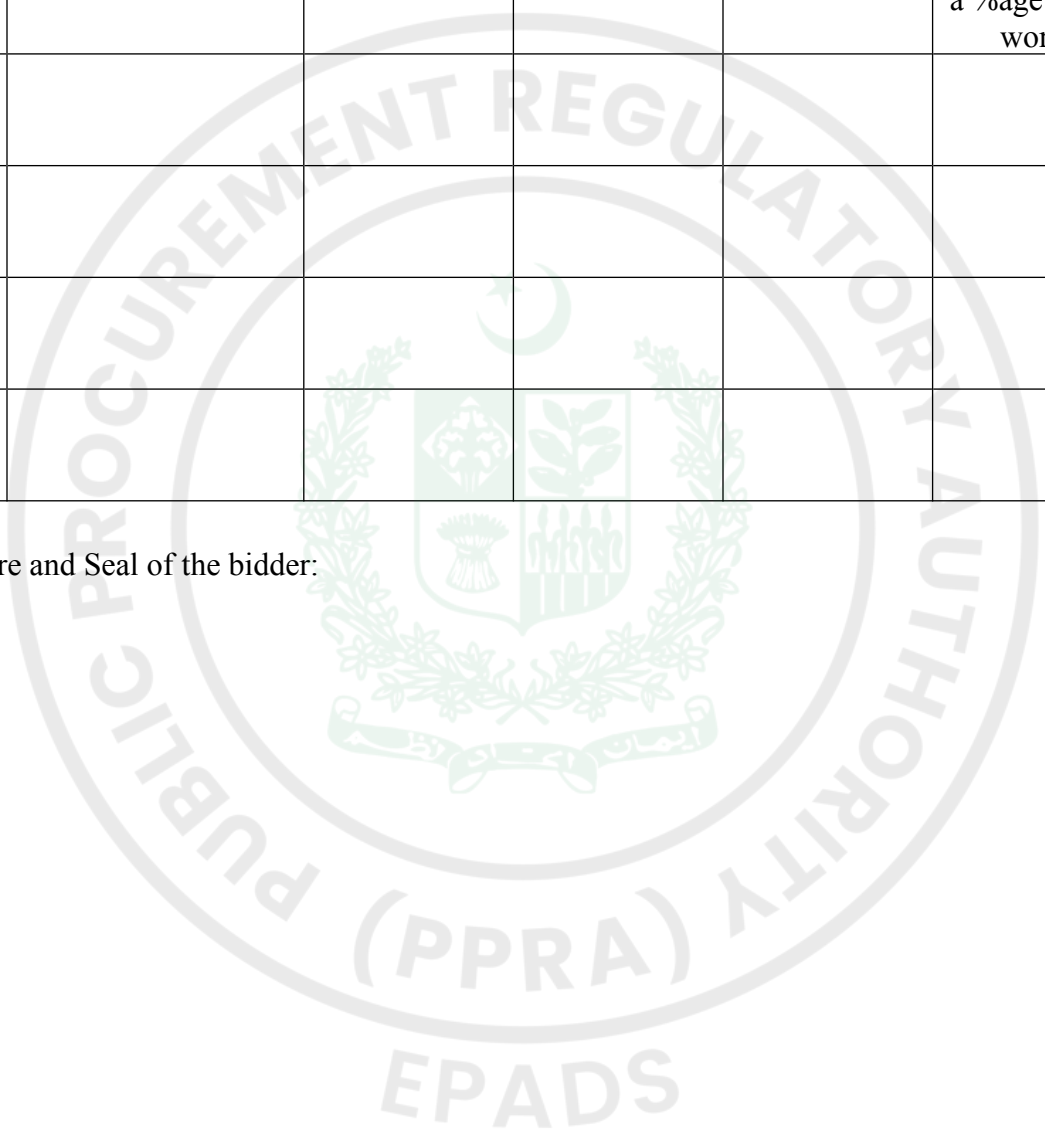



STANDARD FORMS

BID SECURITY (Bank Guarantee)

Security Executed on _____
(Date)

Name of Surety (Bank) with Address: _____
(Scheduled Bank in Pakistan)

Name of Principal (Bidder) with Address _____

Guaranteed Amount/ Sum of Security Rupees. _____ (Rs. _____)

Bid Reference No. _____

KNOW ALL MEN BY THESE PRESENTS, that in pursuance of the terms of the Bid and at the request of the said Principal (Bidder) we, the Surety above named, are held and firmly bound unto **Project Director (EHV) NTDC** (hereinafter called the 'Employer') in the sum stated above for the payment of which sum well and truly to be made, we bind ourselves, our heirs, executors, administrators and successors, jointly and severally, firmly by these presents.

THE CONDITION OF THIS OBLIGATION IS SUCH, that whereas the Bidder has submitted the accompanying Bid dated _____ for Bid No. _____ for _____ (Particulars of Bid) to the said Employer; and

WHEREAS, the Employer has required as a condition for considering said Bid that the Bidder furnishes a Bid Security in the above said sum from a Scheduled Bank in Pakistan or from a foreign bank duly counter-guaranteed by a Scheduled Bank in Pakistan, to the Employer, conditioned as under:

- (1) that the Bid Security shall remain in force up to and including the date 28 days after the deadline for validity of bids as stated in the Instructions to Bidders or as it may be extended by the Employer, notice of which extension(s) to the Surety is hereby waived;
- (2) that the Bid Security of unsuccessful Bidders will be returned by the Employer after expiry of its validity or upon signing of the Contract Agreement; and
- (3) that in the event of failure of the successful Bidder to execute the proposed Contract Agreement, involvement in corrupt and/or fraudulent practices, and/or furnish the required Performance Security, the entire said sum be paid immediately to the said Employer pursuant to Clause 15.6 of the Instruction to Bidders for the successful Bidder's failure to perform.

NOW THEREFORE, if the successful Bidder shall, within the period specified therefor, on the prescribed form presented to him for signature enter into a formal Contract with the said Employer in accordance with his Bid as accepted and furnish within fourteen (14) days of his being requested to do so, a Performance Security with good and sufficient surety, as may be required, upon the form prescribed by the said Employer for the faithful performance and proper fulfilment of the said Contract or in the event of non-withdrawal of the said Bid within the time specified for its validity then this obligation shall be void and of no effect, but otherwise to remain in full force and effect.

PROVIDED THAT the Surety shall forthwith pay the Employer the said sum upon first written demand of the Employer (without cavil or argument) and without recourse to the Principal or any other third party in the necessity any proceeding whatever judicial or otherwise irrespective of any dispute, difference or disagreement between the Bidder and the Employer or contestation by any other party/person. We agree that for the purpose of this Bid Bond, the Employer shall be the sole and exclusive judge for determining whether events listed in ____ above have occurred and any written demand made in the manner stipulated herein by the Employer shall be conclusive evidence of the occurrence of one or more of the events listed above. We shall at all times be bound to the first written demand of the Employer to pay the Employer forthwith the amount hereby agreed and without requiring the Employer to prove or to show grounds or reasons for such demand, notice of which shall be sent by the Employer by registered post duly addressed to the Surety at its address given above.

PROVIDED ALSO THAT the Employer shall be the sole and final judge for deciding whether the Principal (Bidder) has duly performed his obligations to sign the Contract Agreement and to furnish the requisite Performance Security within the time stated above, or has defaulted in fulfilling said requirements and the Surety shall pay without objection the said sum upon demand from the Employer forthwith and without any reference to the Principal (Bidder) or any other person.

IN WITNESS WHEREOF, the above bounden Surety has executed the instrument under its seal on the date indicated above, the name and seal of the Surety being hereto affixed and these presents duly signed by its undersigned representative pursuant to authority of its governing body.

SURETY (Bank)

WITNESS:

Signature _____

1. _____

Name _____

Title _____

Corporate Secretary (Seal)

Corporate Guarantor (Seal)

2. _____

Name, Title & Address

**FORM OF PERFORMANCE SECURITY
(Bank Guarantee)**

Guarantee No. _____
 Executed on _____
 Expiry date _____

[Letter by the Guarantor to the Employer]

Name of Guarantor (Bank) with address: _____
 (Scheduled Bank in Pakistan)

Name of Principal (Supplier or Contractor) with address: _____

Guaranteed Amount/Sum of Security against services/works/contracts (express in words and figures) _____.

(Hereinafter referred to as the "Bank/Guarantor" which expression shall be deemed to include its respective successors-in-interest and assignee and shall be deemed as well to include any financial institutions which may subsequently become the party).

Letter of Acceptance No. _____ Dated _____

KNOW ALL MEN BY THESE PRESENTS, that in pursuance of the terms of the Bidding Documents and above said Letter of Acceptance (hereinafter called the Documents) and at the request of the said Principal we, the Guarantor above named, are held and firmly bound unto **Project Director (EHV) NTDC Lahore** hereinafter called the "Employer") in the Guaranteed Amount/Sum stated above for the payment of which sum well and truly to be made to the said Employer, we bind ourselves, our heirs, executors, administrators and successors, jointly and severally, firmly by these presents.

THE CONDITION OF THIS OBLIGATION IS SUCH, that whereas the Principal has accepted the Employer's above said Letter of Acceptance for _____
 _____ (Name of Contract) for the _____
 _____ (Name of Project).

NOW THEREFORE, if the Principal (Contractor) shall well and truly perform and fulfill all the undertakings, covenants, terms and conditions of the said Documents during the original terms of the said Documents and any extensions thereof that may be granted by the Employer, with or without notice to the Guarantor, which notice is, hereby, waived and shall also well and truly perform and fulfill all the undertakings, covenants terms and conditions of the Contract and of any and all modifications of said Documents that may hereafter be made, notice of which modifications to the Guarantor being hereby waived, then, this obligation to be void; otherwise to remain in full force and virtue till the issuance of Warranty Certificate in accordance with Clause ___, Warranty, of Conditions of Contract.

Our total liability under this Guarantee is limited to the Sum stated herein above and it is a condition of any liability attaching to us under this Guarantee that the claim for payment in writing shall be received by us within the validity period of this Guarantee which Sum we irrevocably and unconditionally agree to pay immediately upon any request for payment or demand received on which/the end __ (date), failing which we shall be discharged of our

liability, if any, under this Guarantee.

We, _____ (the Guarantor), waiving all objections and defenses under the Contract, do hereby unconditionally, irrevocably and independently guarantee and undertake to pay to the Employer without protest, demur, delay and without reference, notice or recourse to contractor to any other person upon the Employer's first written demand without cavil or arguments and without requiring the Employer to prove or to show grounds or reasons for such demand and hereby expressly waive all rights to deny our obligation to the Employer irrespective of any dispute, difference, ongoing litigation, arbitration proceeding or disagreement between ___ and ___ , or contestations by any other party or person, any Sum or Sums up to the amount stated above, against the Employer's written declaration that the Principal has refused or failed to perform the obligations under the Contract which payment will be effected by the Guarantor to Employer's designated Bank & Account Number.

PROVIDED ALSO THAT the Employer shall be the sole, exclusive and final judge for deciding whether the Principal has duly performed his obligations under the Contract or has defaulted in fulfilling said obligations and any written demand to the Guarantor made in the manners specified above shall be conclusive evidence of failure to comply with, ___ and the Guarantor shall pay without objection any Sum or Sums up to the amount stated above upon first written demand from the Employer forthwith and without any reference to the Principal or any other person.

The Guarantee shall be a continuing security and shall remain in operation until ___ after the expiration, termination of the contract or any extension thereto.

PROVIDED FURTHER THAT until the expiry date of the Guarantee, the Employer shall be entitled to present written demand(s) to the Guarantor in the manner specified above for any amount up to the aggregate Guaranteed Amount. The Guarantor agrees that nothing in this Guarantee shall bar the Employer from presenting multiple written demands to the Guarantor, provided that the amount claimed in the written demand(s) shall not collectively exceed the aggregate Guaranteed Amount.

IN WITNESS, WHEREOF, the above-bounden Guarantor has executed this Instrument under its seal on the date indicated above, the name and; corporate seal of the Guarantor being hereto affixed and these presents duly signed by its undersigned representative, pursuant to authority of its governing body.

	_____ Guarantor (Bank)
Witness:	
1. _____	Signature _____
_____	Name _____
Corporate Secretary (Seal)	Title _____
2. _____	
_____	_____
Name, Title & Address	Corporate Guarantor (Seal)

FORM OF CONTRACT AGREEMENT

THIS CONTRACT AGREEMENT (hereinafter called the "Agreement") made on the _____ day of _____ (month) 20____ between _____ (hereafter called the "Employer") of the one part and _____ (hereafter called the "Contractor") of the other part.

WHEREAS the Employer is desirous that certain Works, viz _____ should be executed by the Contractor and has accepted a Bid by the Contractor for the execution and completion of such Works and the remedying of any defects therein.

NOW this Agreement witnesseth as follows:

1. In this Agreement words and expressions shall have the same meanings as are respectively assigned to them in the Conditions of Contract hereinafter referred to.
2. The following documents after incorporating addenda, if any, except those parts relating to Instructions to Bidders shall be deemed to form and be read and construed as part of this Agreement, viz:
 - (a) The Contract Agreement;
 - (b) The Letter of Acceptance;
 - (c) The completed Form of Bid;
 - (d) Special Stipulations (Appendix-A to Bid);
 - (e) The Particular Conditions of Contract;
 - (f) The General Conditions;
 - (g) The priced Bill of Quantities;
 - (h) The completed Appendices to Bid;
 - (i) The Drawings;
 - (j) The Specifications.
 - (k) _____ (any other)
3. In consideration of the payments to be made by the Employer to the Contractor as hereinafter mentioned, the Contractor hereby covenants with the Employer to execute and complete the Works and remedy defects therein in conformity and in all respects with the provisions of the Contract.
4. The Employer hereby covenants to pay the Contractor, in consideration of the execution and completion of the Works as per provisions of the Contract, the Contract Price or such other sum as may become payable under the provisions of the Contract at the times and in the manner prescribed by the Contract.

IN WITNESS WHEREOF the parties hereto have caused this Agreement to be executed

on the day, month and year first before written in accordance with their respective laws.

Signature of the Contactor

Signature of Employer

(Seal)

(Seal)

Signed, Sealed and Delivered in the presence of:

Witness:

Witness:

(Name, Title and Address)

(Name, Title and Address)

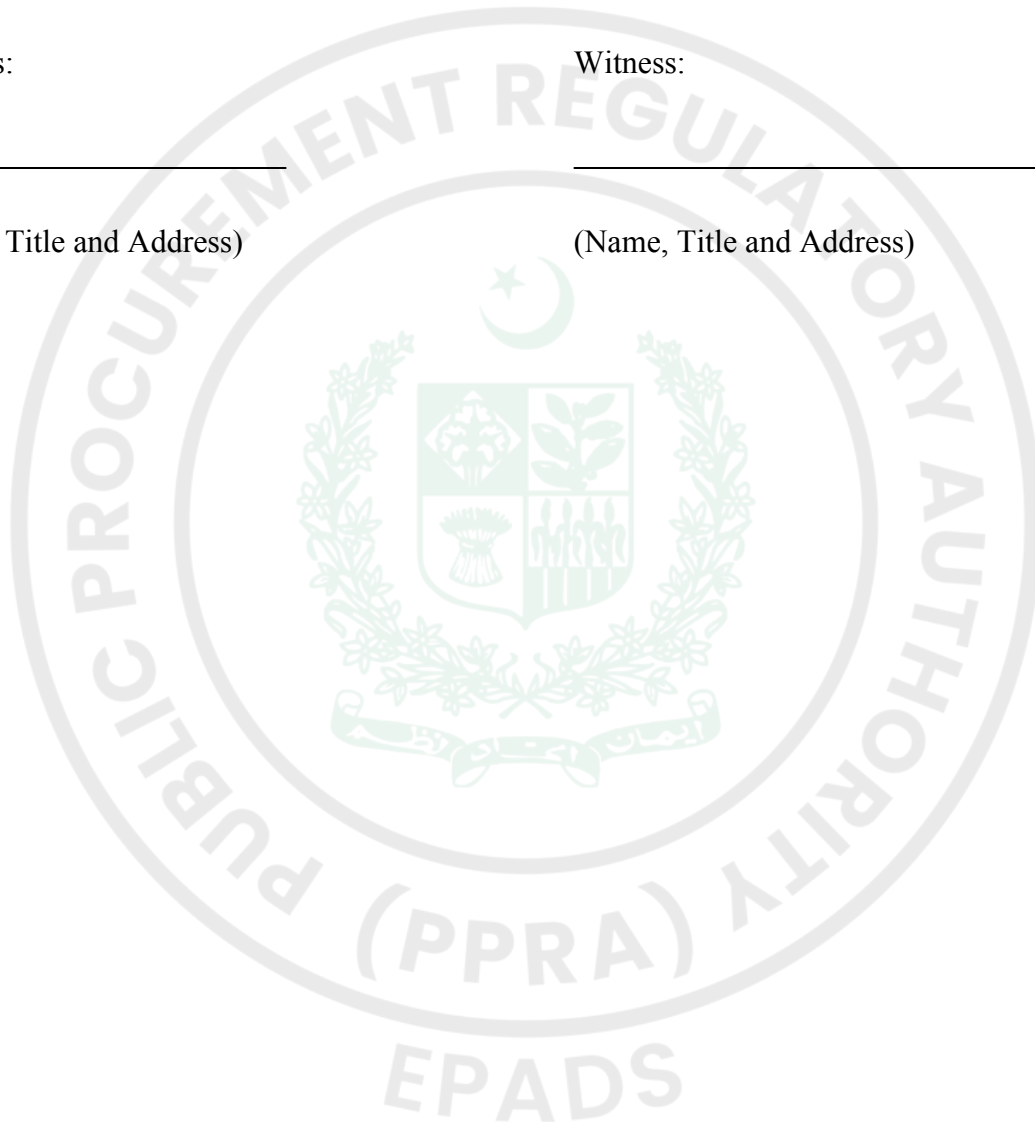

MOBILIZATION ADVANCE GUARANTEE/BOND (Not Applicable)

Guarantee No. _____ Date _____

WHEREAS _____ (hereinafter called the 'Employer') has entered into a Contract for

_____ (Particulars of Contract)

with _____ (hereinafter called the "Contractor").

AND WHEREAS, the Employer has agreed to advance to the Contractor, at the Contractor's request, an amount of Rupees _____ (Rs _____) which amount shall be advanced to the Contractor as per provisions of the Contract.

AND WHEREAS, the Employer has asked the Contractor to furnish Guarantee to secure the mobilization advance for the performance of his obligations under the said Contract.

AND WHEREAS, _____
(Scheduled Bank in Pakistan or Insurance Company acceptable to the Employer)
(hereinafter called the "Guarantor") at the request of the Contractor and in consideration of the Employer agreeing to make the above advance to the Contractor, has agreed to furnish the said Guarantee.

NOW, THEREFORE, the Guarantor hereby guarantees that the Contractor shall use the advance for the purpose of above-mentioned Contract and if he fails and commits default in fulfilment of any of his obligations for which the advance payment is made, the Guarantor shall be liable to the Employer for payment not exceeding the aforementioned amount.

Notice in writing of any default, of which the Employer shall be the sole and final judge, on the part of the Contractor, shall be given by the Employer to the Guarantor, and on such first written demand, payment shall be made by the Guarantor of all sums then due under this Guarantee without any reference to the Contractor and without any objection.

This Guarantee shall remain in force until the advance is fully adjusted against payments from the Interim Payment Certificates of the Contractor or until _____ whichever is earlier.

(Date)

The Guarantor's liability under this Guarantee shall not in any case exceed the sum of Rupees _____ (Rs _____).

This Guarantee shall remain valid up to the aforesaid date and shall be null and void after the aforesaid date or earlier if the advance made to the Contractor is fully adjusted against payments from Interim Payment Certificates of the Contractor provided that the Guarantor agrees that the aforesaid period of validity shall be deemed to be extended if on the above mentioned date the advance payment is not fully adjusted.

GUARANTOR

- 1. Signature _____
- 2. Name _____
- 3. Title _____

WITNESS

1. _____

Corporate Secretary (Seal)

2. _____

(Name Title & Address)

Corporate Guarantor (Seal)

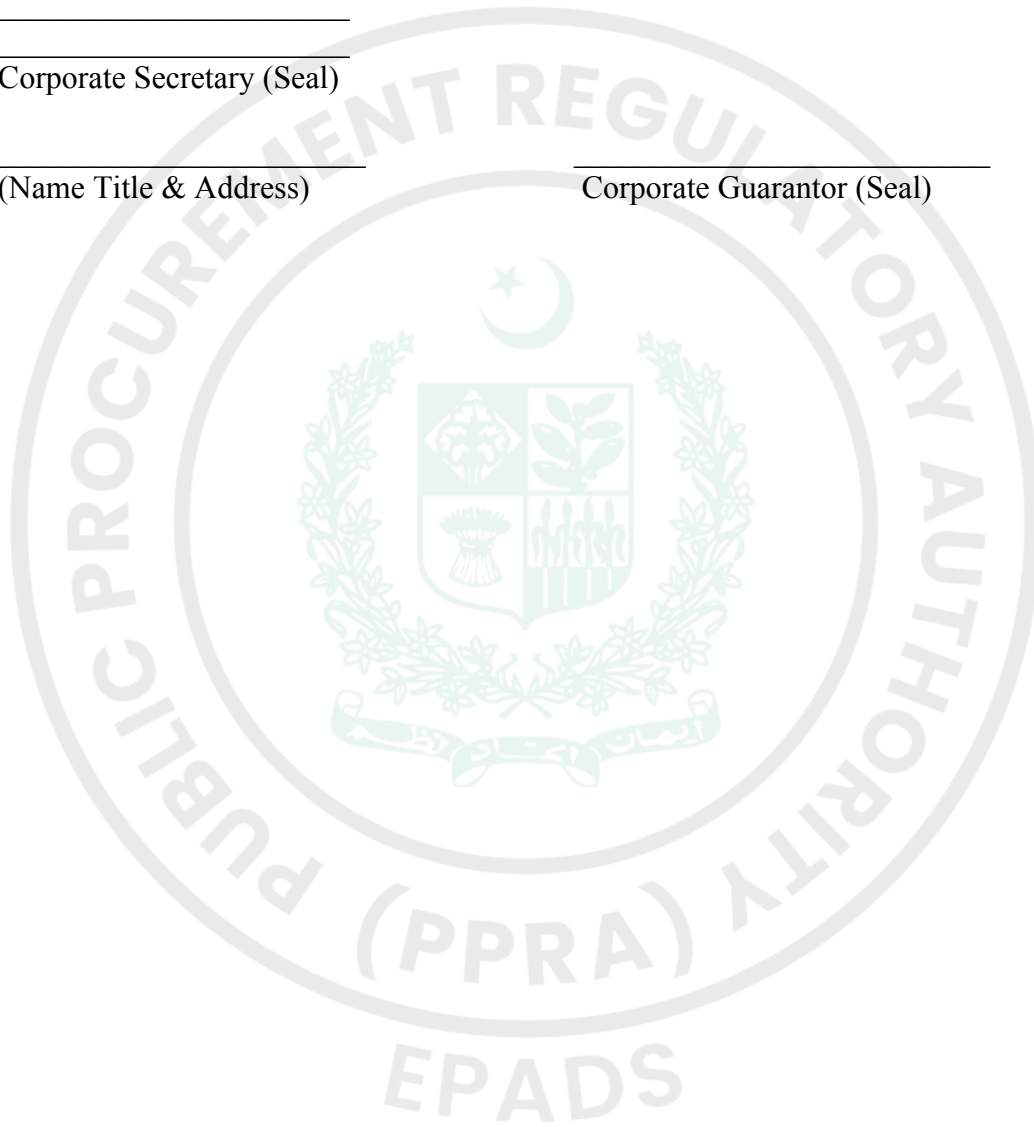

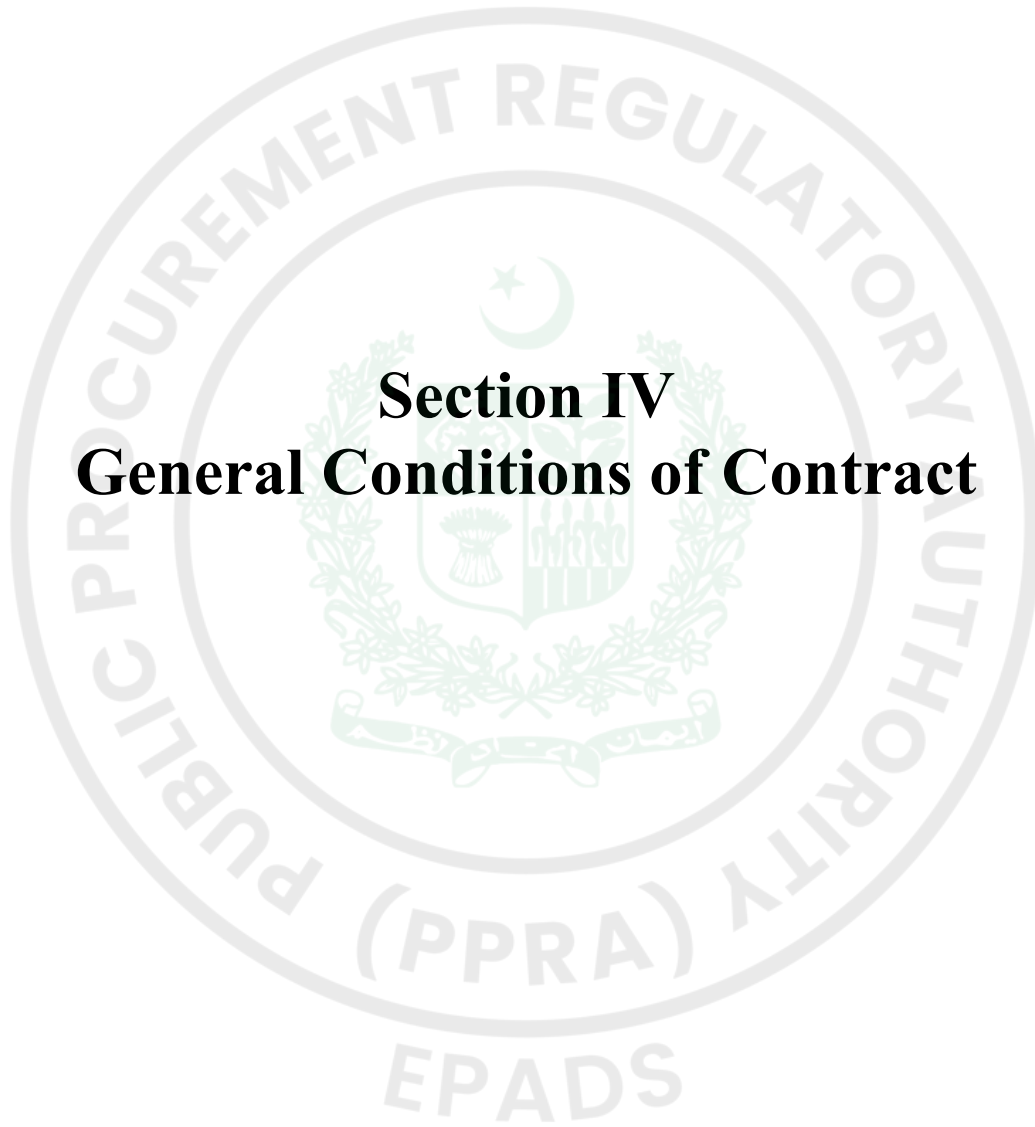

Section IV

General Conditions of Contract

SECTION-IV GENERAL CONDITIONS OF CONTRACT

This bidding document follows the FIDIC conditions of contract for construction works. The Conditions of Contract Comprise of two Sections: Section-IV – General Conditions of Contract, and Section-V – Special Conditions of Contract.

All the general Conditions shall be as per the FIDIC documents indicated below. These shall be read along with the Particular Conditions of Contract for interpretation. In case of any discrepancy between these General Conditions of Contract and the Particular Conditions of the Contract of Section-V, the provisions under the latter shall govern.

FIDIC

FEDERATION INTERNATIONALE DES INGENIEURS – CONSEILS

CONDITIONS OF CONTRACT
FOR WORKS OF CIVIL
ENGINEERING CONSTRUCTION

FOURTH EDITION 1987

Reprinted 1988 with editorial amendments

Reprinted 1992 with editorial amendments



FEDERATION INTERNATIONALE DES INGENIEURS-CONSEILS

CONDITIONS OF CONTRACT

FOR WORKS OF CIVIL

ENGINEERING CONSTRUCTION

**PART I GENERAL CONDITIONS
WITH FORMS OF TENDER AND AGREEMENT**

**PART II CONDITIONS OF PARTICULAR APPLICATION
WITH GUIDELINES FOR PREPARATION OF PART II CLAUSES**

FOURTH EDITION 1987

Reprinted 1988 with editorial amendments

Reprinted 1992 with further amendments



FEDERATION INTERNATIONALE DES INGENIEURS-CONSEILS

CONDITIONS OF CONTRACT

FOR WORKS OF CIVIL

ENGINEERING CONSTRUCTION

**PART I GENERAL CONDITIONS
WITH FORMS OF TENDER AND AGREEMENT**

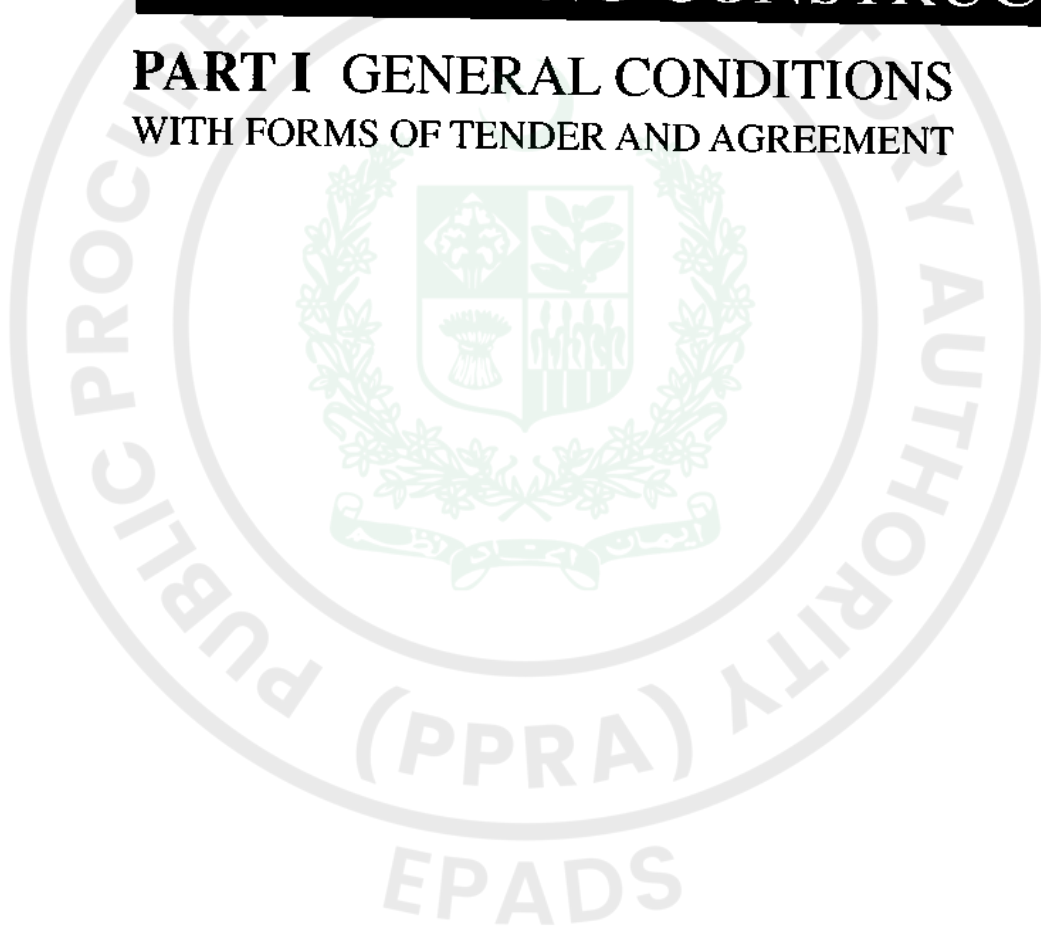

FOURTH EDITION 1987
Reprinted 1988 with editorial amendments
Reprinted 1992 with further amendments

FOREWORD

The terms of the Fourth Edition of the Conditions of Contract for Works of Civil Engineering Construction have been prepared by the Fédération Internationale des Ingénieurs Conseils (FIDIC) and are recommended for general use for the purpose of construction of such works where tenders are invited on an international basis. The Conditions, subject to minor modifications, are also suitable for use on domestic contracts.

The version in English of the Conditions is considered by FIDIC as the official and authentic text for the purpose of translation.

In the preparation of the Conditions it was recognised that while there are numerous Clauses which will be generally applicable there are some Clauses which must necessarily vary to take account of the circumstances and locality of the Works. The Clauses of general application have been grouped together in this document and are referred to as Part I – General Conditions. They have been printed in a form which will facilitate their inclusion as printed in the contract documents normally prepared.

The General Conditions are linked with the Conditions of Particular Application, referred to as Part II, by the corresponding numbering of the Clauses, so that Parts I and II together comprise the Conditions governing the rights and obligations of the parties.

Part II must be specially drafted to suit each individual Contract.

When dredging and certain types of reclamation work are involved special consideration must be given to Part II.

To assist in the preparation of Part II explanatory material and example clauses are published with the Conditions in a separately bound document entitled “Conditions of Contract for Works of Civil Engineering Construction, Part II – Conditions of Particular Application, with Guidelines for preparation of Part II Clauses, Fourth Edition”.

FIDIC has published a “Guide to the Use of FIDIC Conditions of Contract for Works of Civil Engineering Construction” which includes comments on the provisions of the Fourth Edition of the Conditions. Users of the Fourth Edition may find it helpful to refer to this Guide.

It may also be helpful for users to refer to other FIDIC publications, such as:

Tendering Procedure (First Edition 1982)
Construction, Insurance and Law (1986)

FIDIC gratefully acknowledges the suggestions and comments it has received during the preparation of this edition from European International Contractors (EIC) as mandatory of Confederation of International Contractors Associations (CICA) with participation of Associated General Contractors of America (AGC).

CONTENTS

PART I: GENERAL CONDITIONS

Definitions and Interpretation

1.1	Definitions	1
1.2	Headings and Marginal Notes	2
1.3	Interpretation	2
1.4	Singular and Plural	2
1.5	Notices, Consents, Approvals, Certificates and Determinations	3

Engineer and Engineer's Representative

2.1	Engineer's Duties and Authority	3
2.2	Engineer's Representative	3
2.3	Engineer's Authority to Delegate	3
2.4	Appointment of Assistants	3
2.5	Instructions in Writing	3
2.6	Engineer to Act Impartially	4

Assignment and Subcontracting

3.1	Assignment of Contract	4
4.1	Subcontracting	4
4.2	Assignment of Subcontractors' Obligations	4

Contract Documents

5.1	Language/s and Law	4
5.2	Priority of Contract Documents	5
6.1	Custody and Supply of Drawings and Documents	5
6.2	One Copy of Drawings to be Kept on Site	5
6.3	Disruption of Progress	5
6.4	Delays and Cost of Delay of Drawings	5
6.5	Failure by Contractor to Submit Drawings	5
7.1	Supplementary Drawings and Instructions	6
7.2	Permanent Works Designed by Contractor	6
7.3	Responsibility Unaffected by Approval	6

General Obligations

8.1	Contractor's General Responsibilities	6
8.2	Site Operations and Methods of Construction	6
9.1	Contract Agreement	6
10.1	Performance Security	6
10.2	Period of Validity of Performance Security	7
10.3	Claims under Performance Security	7
11.1	Inspection of Site	7
12.1	Sufficiency of Tender	7
12.2	Not Foreseeable Physical Obstructions or Conditions	7
13.1	Work to be in Accordance with Contract	8
14.1	Programme to be Submitted	8
14.2	Revised Programme	8
14.3	Cash Flow Estimate to be Submitted	8
14.4	Contractor not Relieved of Duties or Responsibilities	8
15.1	Contractor's Superintendence	8

16.1	Contractor's Employees	8
16.2	Engineer at Liberty to Object	8
17.1	Setting-out	9
18.1	Boreholes and Exploratory Excavation	9
19.1	Safety, Security and Protection of the Environment	9
19.2	Employer's Responsibilities	9
20.1	Care of Works	9
20.2	Responsibility to Rectify Loss or Damage	10
20.3	Loss or Damage Due to Employer's Risks	10
20.4	Employer's Risks	10
21.1	Insurance of Works and Contractor's Equipment	10
21.2	Scope of Cover	11
21.3	Responsibility for Amounts not Recovered	11
21.4	Exclusions	11
22.1	Damage to Persons and Property	11
22.2	Exceptions	11
22.3	Indemnity by Employer	12
23.1	Third Party Insurance (including Employer's Property)	12
23.2	Minimum Amount of Insurance	12
23.3	Cross Liabilities	12
24.1	Accident or Injury to Workmen	12
24.2	Insurance Against Accident to Workmen	12
25.1	Evidence and Terms of Insurances	12
25.2	Adequacy of Insurances	12
25.3	Remedy on Contractor's Failure to Insure	12
25.4	Compliance with Policy Conditions	12
26.1	Compliance with Statutes, Regulations	13
27.1	Fossils	13
28.1	Patent Rights	13
28.2	Royalties	13
29.1	Interference with Traffic and Adjoining Properties	13
30.1	Avoidance of Damage to Roads	14
30.2	Transport of Contractor's Equipment or Temporary Works	14
30.3	Transport of Materials or Plant	14
30.4	Waterborne Traffic	14
31.1	Opportunities for Other Contractors	14
31.2	Facilities for Other Contractors	14
32.1	Contractor to Keep Site Clear	15
33.1	Clearance of Site on Completion	15

Labour

34.1	Engagement of Staff and Labour	15
35.1	Returns of Labour and Contractor's Equipment	15

Materials, Plant and Workmanship

36.1	Quality of Materials, Plant and Workmanship	15
36.2	Cost of Samples	15
36.3	Cost of Tests	15
36.4	Cost of Tests not Provided for	16
36.5	Engineer's Determination where Tests not Provided for	16
37.1	Inspection of Operations	16
37.2	Inspection and Testing	16
37.3	Dates for Inspection and Testing	16
37.4	Rejection	16
37.5	Independent Inspection	17
38.1	Examination of Work before Covering up	17

38.2	Uncovering and Making Openings	17
39.1	Removal of Improper Work, Materials or Plant	17
39.2	Default of Contractor in Compliance	17

Suspension

40.1	Suspension of Work	17
40.2	Engineer's Determination following Suspension	18
40.3	Suspension lasting more than 84 Days	18

Commencement and Delays

41.1	Commencement of Works	18
42.1	Possession of Site and Access Thereto	18
42.2	Failure to Give Possession	19
42.3	Rights of Way and Facilities	19
43.1	Time for Completion	19
44.1	Extension of Time for Completion	19
44.2	Contractor to Provide Notification and Detailed Particulars	19
44.3	Interim Determination of Extension	19
45.1	Restriction on Working Hours	20
46.1	Rate of Progress	20
47.1	Liquidated Damages for Delay	20
47.2	Reduction of Liquidated Damages	20
48.1	Taking-Over Certificate	21
48.2	Taking-Over of Sections or Parts	21
48.3	Substantial Completion of Parts	21
48.4	Surfaces Requiring Reinstatement	21

Defects Liability

49.1	Defects Liability Period	21
49.2	Completion of Outstanding Work and Remedying Defects	22
49.3	Cost of Remedying Defects	22
49.4	Contractor's Failure to Carry Out Instructions	22
50.1	Contractor to Search	22

Alterations, Additions and Omissions

51.1	Variations	22
51.2	Instructions for Variations	23
52.1	Valuation of Variations	23
52.2	Power of Engineer to Fix Rates	23
52.3	Variations Exceeding 15 percent	23
52.4	Daywork	24

Procedure for Claims

53.1	Notice of Claims	24
53.2	Contemporary Records	24
53.3	Substantiation of Claims	25
53.4	Failure to Comply	25
53.5	Payment of Claims	25

Contractor's Equipment, Temporary Works and Materials

54.1	Contractor's Equipment, Temporary Works and Materials; Exclusive Use for the Works	25
54.2	Employer not Liable for Damage	25
54.3	Customs Clearance	25

54.4	Re-export of Contractor's Equipment	25
54.5	Conditions of Hire of Contractor's Equipment	26
54.6	Costs for the Purpose of Clause 63	26
54.7	Incorporation of Clause in Subcontracts	26
54.8	Approval of Materials not Implied	26

Measurement

55.1	Quantities	26
56.1	Works to be Measured	26
57.1	Method of Measurement	27
57.2	Breakdown of Lump Sum Items	27

Provisional Sums

58.1	Definition of "Provisional Sum"	27
58.2	Use of Provisional Sums	27
58.3	Production of Vouchers	27

Nominated Subcontractors

59.1	Definition of "Nominated Subcontractors"	27
59.2	Nominated Subcontractors; Objection to Nomination	27
59.3	Design Requirements to be Expressly Stated	28
59.4	Payments to Nominated Subcontractors	28
59.5	Certification of Payments to Nominated Subcontractors	28

Certificates and Payment

60.1	Monthly Statements	29
60.2	Monthly Payments	29
60.3	Payment of Retention Money	29
60.4	Correction of Certificates	29
60.5	Statement at Completion	30
60.6	Final Statement	30
60.7	Discharge	30
60.8	Final Payment Certificate	30
60.9	Cessation of Employer's Liability	30
60.10	Time for Payment	31
61.1	Approval only by Defects Liability Certificate	31
62.1	Defects Liability Certificate	31
62.2	Unfulfilled Obligations	31

Remedies

63.1	Default of Contractor	31
63.2	Valuation at Date of Termination	32
63.3	Payment after Termination	32
63.4	Assignment of Benefit of Agreement	32
64.1	Urgent Remedial Work	32

Special Risks

65.1	No Liability for Special Risks	33
65.2	Special Risks	33
65.3	Damage to Works by Special Risks	33
65.4	Projectile, Missile	33
65.5	Increased Costs arising from Special Risks	33
65.6	Outbreak of War	33
65.7	Removal of Contractor's Equipment on Termination	34
65.8	Payment if Contract Terminated	34

	Release from Performance	
66.1	Payment in Event of Release from Performance	35
	Settlement of Disputes	
67.1	Engineer's Decision	35
67.2	Amicable Settlement	35
67.3	Arbitration	36
67.4	Failure to Comply with Engineer's Decision	36
	Notices	
68.1	Notice to Contractor	36
68.2	Notice to Employer and Engineer	36
68.3	Change of Address	36
	Default of Employer	
69.1	Default of Employer	36
69.2	Removal of Contractor's Equipment	37
69.3	Payment on Termination	37
69.4	Contractor's Entitlement to Suspend Work	37
69.5	Resumption of Work	37
	Changes in Cost and Legislation	
70.1	Increase or Decrease of Cost	37
70.2	Subsequent Legislation	37
	Currency and Rates of Exchange	
71.1	Currency Restrictions	38
72.1	Rates of Exchange	38
72.2	Currency Proportions	38
72.3	Currencies of Payment for Provisional Sums	38
	REFERENCE TO PART II	
	INDEX	
	TENDER	
	AGREEMENT	
	EDITORIAL AMENDMENTS IN 1988	
	FURTHER AMENDMENTS IN 1992	

PART I - GENERAL CONDITIONS

Definitions and Interpretation

Definitions

1.1

In the Contract (as hereinafter defined) the following words and expressions shall have the meanings hereby assigned to them, except where the context otherwise requires:

- (a) (i) "Employer" means the person named as such in Part II of these Conditions and the legal successors in title to such person, but not (except with the consent of the Contractor) any assignee of such person.
 - (ii) "Contractor" means the person whose tender has been accepted by the Employer and the legal successors in title to such person, but not (except with the consent of the Employer) any assignee of such person.
 - (iii) "Subcontractor" means any person named in the Contract as a Subcontractor for a part of the Works or any person to whom a part of the Works has been subcontracted with the consent of the Engineer and the legal successors in title to such person, but not any assignee of any such person.
 - (iv) "Engineer" means the person appointed by the Employer to act as Engineer for the purposes of the Contract and named as such in Part II of these Conditions.
 - (v) "Engineer's Representative" means a person appointed from time to time by the Engineer under Sub-Clause 2.2.
- (b) (i) "Contract" means these Conditions (Parts I and II), the Specification, the Drawings, the Bill of Quantities, the Tender, the Letter of Acceptance, the Contract Agreement (if completed) and such further documents as may be expressly incorporated in the Letter of Acceptance or Contract Agreement (if completed).
 - (ii) "Specification" means the specification of the Works included in the Contract and any modification thereof or addition thereto made under Clause 51 or submitted by the Contractor and approved by the Engineer.
 - (iii) "Drawings" means all drawings, calculations and technical information of a like nature provided by the Engineer to the Contractor under the Contract and all drawings, calculations, samples, patterns, models, operation and maintenance manuals and other technical information of a like nature submitted by the Contractor and approved by the Engineer.
 - (iv) "Bill of Quantities" means the priced and completed bill of quantities forming part of the Tender.
 - (v) "Tender" means the Contractor's priced offer to the Employer for the execution and completion of the Works and the remedying of any defects therein in accordance with the provisions of the Contract, as accepted by the Letter of Acceptance.
 - (vi) "Letter of Acceptance" means the formal acceptance by the Employer of the Tender.
 - (vii) "Contract Agreement" means the contract agreement (if any) referred to in Sub-Clause 9.1.
 - (viii) "Appendix to Tender" means the appendix comprised in the form of Tender annexed to these Conditions.
- (c) (i) "Commencement Date" means the date upon which the Contractor receives the notice to commence issued by the Engineer pursuant to Clause 41.
 - (ii) "Time for Completion" means the time for completing the execution of and passing the Tests on Completion of the Works or any Section or part thereof as stated in the Contract (or as extended under Clause 44) calculated from the Commencement Date.

- (d) (i) “Tests on Completion” means the tests specified in the Contract or otherwise agreed by the Engineer and the Contractor which are to be made by the Contractor before the Works or any Section or part thereof are taken over by the Employer.
- (ii) “Taking-Over Certificate” means a certificate issued pursuant to Clause 48.
- (e) (i) “Contract Price” means the sum stated in the Letter of Acceptance as payable to the Contractor for the execution and completion of the Works and the remedying of any defects therein in accordance with the provisions of the Contract.
- (ii) “Retention Money” means the aggregate of all monies retained by the Employer pursuant to Sub-Clause 60.2(a).
- (iii) “Interim Payment Certificate” means any certificate of payment issued by the Engineer other than the Final Payment Certificate.
- (iv) “Final Payment Certificate” means the certificate of payment issued by the Engineer pursuant to Sub-Clause 60.8.
- (f) (i) “Works” means the Permanent Works and the Temporary Works or either of them as appropriate.
- (ii) “Permanent Works” means the permanent works to be executed (including Plant) in accordance with the Contract.
- (iii) “Temporary Works” means all temporary works of every kind (other than Contractor’s Equipment) required in or about the execution and completion of the Works and the remedying of any defects therein.
- (iv) “Plant” means machinery, apparatus and the like intended to form or forming part of the Permanent Works.
- (v) “Contractor’s Equipment” means all appliances and things of whatsoever nature (other than Temporary Works) required for the execution and completion of the Works and the remedying of any defects therein, but does not include Plant, materials or other things intended to form or forming part of the Permanent Works.
- (vi) “Section” means a part of the Works specifically identified in the Contract as a Section.
- (vii) “Site” means the places provided by the Employer where the Works are to be executed and any other places as may be specifically designated in the Contract as forming part of the Site.
- (g) (i) “cost” means all expenditure properly incurred or to be incurred, whether on or off the Site, including overhead and other charges properly allocable thereto but does not include any allowance for profit.
- (ii) “day” means calendar day.
- (iii) “foreign currency” means a currency of a country other than that in which the Works are to be located.
- (iv) “writing” means any hand-written, type-written, or printed communication, including telex, cable and facsimile transmission.

Headings and Marginal Notes

1.2 The headings and marginal notes in these Conditions shall not be deemed part thereof or be taken into consideration in the interpretation or construction thereof or of the Contract.

Interpretation

1.3 Words importing persons or parties shall include firms and corporations and any organisation having legal capacity.

Singular and Plural

1.4 Words importing the singular only also include the plural and vice versa where the context requires.

**Notices,
Consents,
Approvals,
Certificates and
Determinations**

- 1.5** Wherever in the Contract provision is made for the giving or issue of any notice, consent, approval, certificate or determination by any person, unless otherwise specified such notice, consent, approval, certificate or determination shall be in writing and the words “notify”, “certify” or “determine” shall be construed accordingly. Any such consent, approval, certificate or determination shall not unreasonably be withheld or delayed.

Engineer and Engineer’s Representative

**Engineer’s
Duties and
Authority**

- 2.1** (a) The Engineer shall carry out the duties specified in the Contract.
- (b) The Engineer may exercise the authority specified in or necessarily to be implied from the Contract, provided, however, that if the Engineer is required, under the terms of his appointment by the Employer, to obtain the specific approval of the Employer before exercising any such authority, particulars of such requirements shall be set out in Part II of these Conditions. Provided further that any requisite approval shall be deemed to have been given by the Employer for any such authority exercised by the Engineer.
- (c) Except as expressly stated in the Contract, the Engineer shall have no authority to relieve the Contractor of any of his obligations under the Contract.

**Engineer’s
Representative**

- 2.2** The Engineer’s Representative shall be appointed by and be responsible to the Engineer and shall carry out such duties and exercise such authority as may be delegated to him by the Engineer under Sub-Clause 2.3.

**Engineer’s
Authority to
Delegate**

- 2.3** The Engineer may from time to time delegate to the Engineer’s Representative any of the duties and authorities vested in the Engineer and he may at any time revoke such delegation. Any such delegation or revocation shall be in writing and shall not take effect until a copy thereof has been delivered to the Employer and the Contractor.

Any communication given by the Engineer’s Representative to the Contractor in accordance with such delegation shall have the same effect as though it had been given by the Engineer. Provided that:

- (a) any failure of the Engineer’s Representative to disapprove any work, materials or Plant shall not prejudice the authority of the Engineer to disapprove such work, materials or Plant and to give instructions for the rectification thereof; and
- (b) if the Contractor questions any communication of the Engineer’s Representative he may refer the matter to the Engineer who shall confirm, reverse or vary the contents of such communication.

**Appointment
of Assistants**

- 2.4** The Engineer or the Engineer’s Representative may appoint any number of persons to assist the Engineer’s Representative in the carrying out of his duties under Sub-Clause 2.2. He shall notify to the Contractor the names, duties and scope of authority of such persons. Such assistants shall have no authority to issue any instructions to the Contractor save in so far as such instructions may be necessary to enable them to carry out their duties and to secure their acceptance of materials, Plant or workmanship as being in accordance with the Contract, and any instructions given by any of them for those purposes shall be deemed to have been given by the Engineer’s Representative.

**Instructions
in Writing**

- 2.5** Instructions given by the Engineer shall be in writing, provided that if for any reason the Engineer considers it necessary to give any such instruction orally, the Contractor shall comply with such instruction. Confirmation in writing of such oral instruction given by the Engineer, whether before or after the carrying out of the instruction, shall be deemed to be an instruction within the meaning of this Sub-Clause. Provided further that if the Contractor, within 7 days, confirms in writing to the Engineer any oral instruction of the Engineer and such confirmation is not contradicted in writing within 7 days by the Engineer, it shall be deemed to be an instruction of the Engineer.

The provisions of this Sub-Clause shall equally apply to instructions given by the Engineer's Representative and any assistants of the Engineer or the Engineer's Representative appointed pursuant to Sub-Clause 2.4.

Engineer to Act Impartially

- 2.6** Wherever, under the Contract, the Engineer is required to exercise his discretion by:
- (a) giving his decision, opinion or consent,
 - (b) expressing his satisfaction or approval,
 - (c) determining value, or
 - (d) otherwise taking action which may affect the rights and obligations of the Employer or the Contractor

he shall exercise such discretion impartially within the terms of the Contract and having regard to all the circumstances. Any such decision, opinion, consent, expression of satisfaction, or approval, determination of value or action may be opened up, reviewed or revised as provided in Clause 67.

Assignment and Subcontracting

Assignment of Contract

- 3.1** The Contractor shall not, without the prior consent of the Employer (which consent, notwithstanding the provisions of Sub-Clause 1.5, shall be at the sole discretion of the Employer), assign the Contract or any part thereof, or any benefit or interest therein or thereunder, otherwise than by:

- (a) a charge in favour of the Contractor's bankers of any monies due or to become due under the Contract, or
- (b) assignment to the Contractor's insurers (in cases where the insurers have discharged the Contractor's loss or liability) of the Contractor's right to obtain relief against any other party liable.

Subcontracting

- 4.1** The Contractor shall not subcontract the whole of the Works. Except where otherwise provided by the Contract, the Contractor shall not subcontract any part of the Works without the prior consent of the Engineer. Any such consent shall not relieve the Contractor from any liability or obligation under the Contract and he shall be responsible for the acts, defaults and neglects of any Subcontractor, his agents, servants or workmen as fully as if they were the acts, defaults or neglects of the Contractor, his agents, servants or workmen.

Provided that the Contractor shall not be required to obtain such consent for:

- (a) the provision of labour,
- (b) the purchase of materials which are in accordance with the standards specified in the Contract, or
- (c) the subcontracting of any part of the Works for which the Subcontractor is named in the Contract.

Assignment of Subcontractors' Obligations

- 4.2** In the event of a Subcontractor having undertaken towards the Contractor in respect of the work executed, or the goods, materials, Plant or services supplied by such Subcontractor, any continuing obligation extending for a period exceeding that of the Defects Liability Period under the Contract, the Contractor shall at any time, after the expiration of such Period, assign to the Employer, at the Employer's request and cost, the benefit of such obligation for the unexpired duration thereof.

Contract Documents

Language/s and Law

- 5.1** There is stated in Part II of these Conditions:
- (a) the language or languages in which the Contract documents shall be drawn up, and
 - (b) the country or state the law of which shall apply to the Contract and according to which the Contract shall be construed.

If the said documents are written in more than one language, the language according to which the Contract shall be construed and interpreted is also stated in Part II of these Conditions, being therein designated the "Ruling Language".

- Priority of Contract Documents**
- 5.2** The several documents forming the Contract are to be taken as mutually explanatory of one another, but in case of ambiguities or discrepancies the same shall be explained and adjusted by the Engineer who shall thereupon issue to the Contractor instructions thereon and in such event, unless otherwise provided in the Contract, the priority of the documents forming the Contract shall be as follows:
- (1) The Contract Agreement (if completed);
 - (2) The Letter of Acceptance;
 - (3) The Tender;
 - (4) Part II of these Conditions;
 - (5) Part I of these Conditions; and
 - (6) Any other document forming part of the Contract.
- Custody and Supply of Drawings and Documents**
- 6.1** The Drawings shall remain in the sole custody of the Engineer, but two copies thereof shall be provided to the Contractor free of charge. The Contractor shall make at his own cost any further copies required by him. Unless it is strictly necessary for the purposes of the Contract, the Drawings, Specification and other documents provided by the Employer or the Engineer shall not, without the consent of the Engineer, be used or communicated to a third party by the Contractor. Upon issue of the Defects Liability Certificate, the Contractor shall return to the Engineer all Drawings, Specification and other documents provided under the Contract.
- The Contractor shall supply to the Engineer four copies of all Drawings, Specification and other documents submitted by the Contractor and approved by the Engineer in accordance with Clause 7, together with a reproducible copy of any material which cannot be reproduced to an equal standard by photocopying. In addition the Contractor shall supply such further copies of such Drawings, Specification and other documents as the Engineer may request in writing for the use of the Employer, who shall pay the cost thereof.
- One Copy of Drawings to be Kept on Site**
- 6.2** One copy of the Drawings, provided to or supplied by the Contractor as aforesaid, shall be kept by the Contractor on the Site and the same shall at all reasonable times be available for inspection and use by the Engineer and by any other person authorised by the Engineer in writing.
- Disruption of Progress**
- 6.3** The Contractor shall give notice to the Engineer, with a copy to the Employer, whenever planning or execution of the Works is likely to be delayed or disrupted unless any further drawing or instruction is issued by the Engineer within a reasonable time. The notice shall include details of the drawing or instruction required and of why and by when it is required and of any delay or disruption likely to be suffered if it is late.
- Delays and Cost of Delay of Drawings**
- 6.4** If, by reason of any failure or inability of the Engineer to issue, within a time reasonable in all the circumstances, any drawing or instruction for which notice has been given by the Contractor in accordance with Sub-Clause 6.3, the Contractor suffers delay and/or incurs costs then the Engineer shall, after due consultation with the Employer and the Contractor, determine:
- (a) any extension of time to which the Contractor is entitled under Clause 44, and
 - (b) the amount of such costs, which shall be added to the Contract Price,
- and shall notify the Contractor accordingly, with a copy to the Employer.
- Failure by Contractor to Submit Drawings**
- 6.5** If the failure or inability of the Engineer to issue any drawings or instructions is caused in whole or in part by the failure of the Contractor to submit Drawings, Specification or other documents which he is required to submit under the Contract, the Engineer shall take such failure by the Contractor into account when making his determination pursuant to Sub-Clause 6.4.

Supplementary Drawings and Instructions	7.1	The Engineer shall have authority to issue to the Contractor, from time to time, such supplementary Drawings and instructions as shall be necessary for the purpose of the proper and adequate execution and completion of the Works and the remedying of any defects therein. The Contractor shall carry out and be bound by the same.
Permanent Works Designed by Contractor	7.2	Where the Contract expressly provides that part of the Permanent Works shall be designed by the Contractor, he shall submit to the Engineer, for approval: <p>(a) such drawings, specifications, calculations and other information as shall be necessary to satisfy the Engineer as to the suitability and adequacy of that design, and</p> <p>(b) operation and maintenance manuals together with drawings of the Permanent Works as completed, in sufficient detail to enable the Employer to operate, maintain, dismantle, reassemble and adjust the Permanent Works incorporating that design. The Works shall not be considered to be completed for the purposes of taking over in accordance with Clause 48 until such operation and maintenance manuals, together with drawings on completion, have been submitted to and approved by the Engineer.</p>
Responsibility Unaffected by Approval	7.3	Approval by the Engineer, in accordance with Sub-Clause 7.2, shall not relieve the Contractor of any of his responsibilities under the Contract.

General Obligations

Contractor's General Responsibilities	8.1	The Contractor shall, with due care and diligence, design (to the extent provided for by the Contract), execute and complete the Works and remedy any defects therein in accordance with the provisions of the Contract. The Contractor shall provide all superintendence, labour, materials, Plant, Contractor's Equipment and all other things, whether of a temporary or permanent nature, required in and for such design, execution, completion and remedying of any defects, so far as the necessity for providing the same is specified in or is reasonably to be inferred from the Contract. <p>The Contractor shall give prompt notice to the Engineer, with a copy to the Employer, of any error, omission, fault or other defect in the design of or Specification for the Works which he discovers when reviewing the Contract or executing the Works.</p>
Site Operations and Methods of Construction	8.2	The Contractor shall take full responsibility for the adequacy, stability and safety of all Site operations and methods of construction. Provided that the Contractor shall not be responsible (except as stated hereunder or as may be otherwise agreed) for the design or specification of Permanent Works, or for the design or specification of any Temporary Works not prepared by the Contractor. Where the Contract expressly provides that part of the Permanent Works shall be designed by the Contractor, he shall be fully responsible for that part of such Works, notwithstanding any approval by the Engineer.
Contract Agreement	9.1	The Contractor shall, if called upon so to do, enter into and execute the Contract Agreement, to be prepared and completed at the cost of the Employer, in the form annexed to these Conditions with such modification as may be necessary.
Performance Security	10.1	If the Contract requires the Contractor to obtain security for his proper performance of the Contract, he shall obtain and provide to the Employer such security within 28 days after the receipt of the Letter of Acceptance, in the sum stated in the Appendix to Tender. When providing such security to the Employer, the Contractor shall notify the Engineer of so doing. Such security shall be in the form annexed to these Conditions or in such other form as may be agreed between the Employer and the Contractor. The institution providing such security shall be subject to the approval of the Employer. The cost of complying with the requirements of this Clause shall be borne by the Contractor, unless the Contract otherwise provides.

Period of Validity of Performance Security	10.2	The performance security shall be valid until the Contractor has executed and completed the Works and remedied any defects therein in accordance with the Contract. No claim shall be made against such security after the issue of the Defects Liability Certificate in accordance with Sub-Clause 62.1 and such security shall be returned to the Contractor within 14 days of the issue of the said Defects Liability Certificate.
Claims under Performance Security	10.3	Prior to making a claim under the performance security the Employer shall, in every case, notify the Contractor stating the nature of the default in respect of which the claim is to be made.
Inspection of Site	11.1	<p>The Employer shall have made available to the Contractor, before the submission by the Contractor of the Tender, such data on hydrological and sub-surface conditions as have been obtained by or on behalf of the Employer from investigations undertaken relevant to the Works but the Contractor shall be responsible for his own interpretation thereof.</p> <p>The Contractor shall be deemed to have inspected and examined the Site and its surroundings and information available in connection therewith and to have satisfied himself (so far as is practicable, having regard to considerations of cost and time) before submitting his Tender, as to:</p> <ul style="list-style-type: none"> (a) the form and nature thereof, including the sub-surface conditions, (b) the hydrological and climatic conditions, (c) the extent and nature of work and materials necessary for the execution and completion of the Works and the remedying of any defects therein, and (d) the means of access to the Site and the accommodation he may require, <p>and, in general, shall be deemed to have obtained all necessary information, subject as above mentioned, as to risks, contingencies and all other circumstances which may influence or affect his Tender.</p> <p>The Contractor shall be deemed to have based his Tender on the data made available by the Employer and on his own inspection and examination, all as aforementioned.</p>
Sufficiency of Tender	12.1	The Contractor shall be deemed to have satisfied himself as to the correctness and sufficiency of the Tender and of the rates and prices stated in the Bill of Quantities, all of which shall, except insofar as it is otherwise provided in the Contract, cover all his obligations under the Contract (including those in respect of the supply of goods, materials, Plant or services or of contingencies for which there is a Provisional Sum) and all matters and things necessary for the proper execution and completion of the Works and the remedying of any defects therein.
Not Foreseeable Physical Obstructions or Conditions	12.2	<p>If, however, during the execution of the Works the Contractor encounters physical obstructions or physical conditions, other than climatic conditions on the Site, which obstructions or conditions were, in his opinion, not foreseeable by an experienced contractor, the Contractor shall forthwith give notice thereof to the Engineer, with a copy to the Employer. On receipt of such notice, the Engineer shall, if in his opinion such obstructions or conditions could not have been reasonably foreseen by an experienced contractor, after due consultation with the Employer and the Contractor, determine:</p> <ul style="list-style-type: none"> (a) any extension of time to which the Contractor is entitled under Clause 44, and (b) the amount of any costs which may have been incurred by the Contractor by reason of such obstructions or conditions having been encountered, which shall be added to the Contract Price, <p>and shall notify the Contractor accordingly, with a copy to the Employer. Such determination shall take account of any instruction which the Engineer may issue to the Contractor in connection therewith, and any proper and reasonable measures acceptable to the Engineer which the Contractor may take in the absence of specific instructions from the Engineer.</p>

Work to be in Accordance with Contract	13.1	Unless it is legally or physically impossible, the Contractor shall execute and complete the Works and remedy any defects therein in strict accordance with the Contract to the satisfaction of the Engineer. The Contractor shall comply with and adhere strictly to the Engineer's instructions on any matter, whether mentioned in the Contract or not, touching or concerning the Works. The Contractor shall take instructions only from the Engineer (or his delegate).
Programme to be Submitted	14.1	The Contractor shall, within the time stated in Part II of these Conditions after the date of the Letter of Acceptance, submit to the Engineer for his consent a programme, in such form and detail as the Engineer shall reasonably prescribe, for the execution of the Works. The Contractor shall, whenever required by the Engineer, also provide in writing for his information a general description of the arrangements and methods which the Contractor proposes to adopt for the execution of the Works.
Revised Programme	14.2	If at any time it should appear to the Engineer that the actual progress of the Works does not conform to the programme to which consent has been given under Sub-Clause 14.1, the Contractor shall produce, at the request of the Engineer, a revised programme showing the modifications to such programme necessary to ensure completion of the Works within the Time for Completion.
Cash Flow Estimate to be Submitted	14.3	The Contractor shall, within the time stated in Part II of these Conditions after the date of the Letter of Acceptance, provide to the Engineer for his information a detailed cash flow estimate, in quarterly periods, of all payments to which the Contractor will be entitled under the Contract and the Contractor shall subsequently supply revised cash flow estimates at quarterly intervals, if required to do so by the Engineer.
Contractor not Relieved of Duties or Responsibilities	14.4	The submission to and consent by the Engineer of such programmes or the provision of such general descriptions or cash flow estimates shall not relieve the Contractor of any of his duties or responsibilities under the Contract.
Contractor's Superintendence	15.1	The Contractor shall provide all necessary superintendence during the execution of the Works and as long thereafter as the Engineer may consider necessary for the proper fulfilling of the Contractor's obligations under the Contract. The Contractor, or a competent and authorised representative approved of by the Engineer, which approval may at any time be withdrawn, shall give his whole time to the superintendence of the Works. Such authorised representative shall receive, on behalf of the Contractor, instructions from the Engineer. If approval of the representative is withdrawn by the Engineer, the Contractor shall, as soon as is practicable, having regard to the requirement of replacing him as hereinafter mentioned, after receiving notice of such withdrawal, remove the representative from the Works and shall not thereafter employ him again on the Works in any capacity and shall replace him by another representative approved by the Engineer.
Contractor's Employees	16.1	The Contractor shall provide on the Site in connection with the execution and completion of the Works and the remedying of any defects therein: (a) only such technical assistants as are skilled and experienced in their respective callings and such foremen and leading hands as are competent to give proper superintendence of the Works, and (b) such skilled, semi-skilled and unskilled labour as is necessary for the proper and timely fulfilling of the Contractor's obligations under the Contract.
Engineer at Liberty to Object	16.2	The Engineer shall be at liberty to object to and require the Contractor to remove forthwith from the Works any person provided by the Contractor who, in the opinion of the Engineer, misconducts himself, or is incompetent or negligent in the proper performance of his duties, or whose presence on Site is otherwise considered by the Engineer to be undesirable, and such person shall not be again allowed upon the Works without the consent of the Engineer. Any person so removed from the Works shall be replaced as soon as possible.

Setting-out 17.1 The Contractor shall be responsible for:

(a) the accurate setting-out of the Works in relation to original points, lines and levels of reference given by the Engineer in writing,

(b) the correctness, subject as above mentioned, of the position, levels, dimensions and alignment of all parts of the Works, and

(c) the provision of all necessary instruments, appliances and labour in connection with the foregoing responsibilities.

If, at any time during the execution of the Works, any error appears in the position, levels, dimensions or alignment of any part of the Works, the Contractor, on being required so to do by the Engineer, shall, at his own cost, rectify such error to the satisfaction of the Engineer, unless such error is based on incorrect data supplied in writing by the Engineer, in which case the Engineer shall determine an addition to the Contract Price in accordance with Clause 52 and shall notify the Contractor accordingly, with a copy to the Employer.

The checking of any setting-out or of any line or level by the Engineer shall not in any way relieve the Contractor of his responsibility for the accuracy thereof and the Contractor shall carefully protect and preserve all bench-marks, sight-rails, pegs and other things used in setting-out the Works.

**Boreholes and
Exploratory
Excavation 18.1**

If, at any time during the execution of the Works, the Engineer requires the Contractor to make boreholes or to carry out exploratory excavation, such requirement shall be the subject of an instruction in accordance with Clause 51, unless an item or a Provisional Sum in respect of such work is included in the Bill of Quantities.

**Safety, Security
and Protection of
the Environment 19.1**

The Contractor shall, throughout the execution and completion of the Works and the remedying of any defects therein:

(a) have full regard for the safety of all persons entitled to be upon the Site and keep the Site (so far as the same is under his control) and the Works (so far as the same are not completed or occupied by the Employer) in an orderly state appropriate to the avoidance of danger to such persons,

(b) provide and maintain at his own cost all lights, guards, fencing, warning signs and watching, when and where necessary or required by the Engineer or by any duly constituted authority, for the protection of the Works or for the safety and convenience of the public or others, and

(c) take all reasonable steps to protect the environment on and off the Site and to avoid damage or nuisance to persons or to property of the public or others resulting from pollution, noise or other causes arising as a consequence of his methods of operation.

**Employer's
Responsibilities 19.2**

If under Clause 31 the Employer shall carry out work on the Site with his own workmen he shall, in respect of such work:

(a) have full regard to the safety of all persons entitled to be upon the Site, and

(b) keep the Site in an orderly state appropriate to the avoidance of danger to such persons.

If under Clause 31 the Employer shall employ other contractors on the Site he shall require them to have the same regard for safety and avoidance of danger.

Care of Works 20.1

The Contractor shall take full responsibility for the care of the Works and materials and Plant for incorporation therein from the Commencement Date until the date of issue of the Taking-Over Certificate for the whole of the Works, when the responsibility for the said care shall pass to the Employer. Provided that:

(a) if the Engineer issues a Taking-Over Certificate for any Section or part of the Permanent Works the Contractor shall cease to be liable for the care of that Section or part from the date of issue of the Taking-Over Certificate, when the responsibility for the care of that Section or part shall pass to the Employer, and

(b) the Contractor shall take full responsibility for the care of any outstanding Works and materials and Plant for incorporation therein which he undertakes to finish during the Defects Liability Period until such outstanding Works have been completed pursuant to Clause 49.

Responsibility to Rectify Loss or Damage

20.2 If any loss or damage happens to the Works, or any part thereof, or materials or Plant for incorporation therein, during the period for which the Contractor is responsible for the care thereof, from any cause whatsoever, other than the risks defined in Sub-Clause 20.4, the Contractor shall, at his own cost, rectify such loss or damage so that the Permanent Works conform in every respect with the provisions of the Contract to the satisfaction of the Engineer. The Contractor shall also be liable for any loss or damage to the Works occasioned by him in the course of any operations carried out by him for the purpose of complying with his obligations under Clauses 49 and 50.

Loss or Damage Due to Employer's Risks

20.3 In the event of any such loss or damage happening from any of the risks defined in Sub-Clause 20.4, or in combination with other risks, the Contractor shall, if and to the extent required by the Engineer, rectify the loss or damage and the Engineer shall determine an addition to the Contract Price in accordance with Clause 52 and shall notify the Contractor accordingly, with a copy to the Employer. In the case of a combination of risks causing loss or damage any such determination shall take into account the proportional responsibility of the Contractor and the Employer.

Employer's Risks

20.4 The Employer's risks are:

- (a) war, hostilities (whether war be declared or not), invasion, act of foreign enemies,
- (b) rebellion, revolution, insurrection, or military or usurped power, or civil war,
- (c) ionising radiations, or contamination by radio-activity from any nuclear fuel, or from any nuclear waste from the combustion of nuclear fuel, radio-active toxic explosive or other hazardous properties of any explosive nuclear assembly or nuclear component thereof,
- (d) pressure waves caused by aircraft or other aerial devices travelling at sonic or supersonic speeds.
- (e) riot, commotion or disorder, unless solely restricted to employees of the Contractor or of his Subcontractors and arising from the conduct of the Works,
- (f) loss or damage due to the use or occupation by the Employer of any Section or part of the Permanent Works, except as may be provided for in the Contract,
- (g) loss or damage to the extent that it is due to the design of the Works, other than any part of the design provided by the Contractor or for which the Contractor is responsible, and
- (h) any operation of the forces of nature against which an experienced contractor could not reasonably have been expected to take precautions.

Insurance of Works and Contractor's Equipment

21.1 The Contractor shall, without limiting his or the Employer's obligations and responsibilities under Clause 20, insure:

- (a) the Works, together with materials and Plant for incorporation therein, to the full replacement cost (the term "cost" in this context shall include profit),
- (b) an additional sum of 15 per cent of such replacement cost, or as may be specified in Part II of these Conditions, to cover any additional costs of and incidental to the rectification of loss or damage including professional fees and the cost of demolishing and removing any part of the Works and of removing debris of whatsoever nature, and
- (c) the Contractor's Equipment and other things brought onto the Site by the Contractor, for a sum sufficient to provide for their replacement at the Site.

Scope of Cover	21.2	<p>The insurance in paragraphs (a) and (b) of Sub-Clause 21.1 shall be in the joint names of the Contractor and the Employer and shall cover:</p> <p>(a) the Employer and the Contractor against all loss or damage from whatsoever cause arising, other than as provided in Sub-Clause 21.4, from the start of work at the Site until the date of issue of the relevant Taking-Over Certificate in respect of the Works or any Section or part thereof as the case may be, and</p> <p>(b) the Contractor for his liability:</p> <p style="padding-left: 40px;">(i) during the Defects Liability Period for loss or damage arising from a cause occurring prior to the commencement of the Defects Liability Period, and</p> <p style="padding-left: 40px;">(ii) for loss or damage occasioned by the Contractor in the course of any operations carried out by him for the purpose of complying with his obligations under Clauses 49 and 50.</p>
Responsibility for Amounts not Recovered	21.3	<p>Any amounts not insured or not recovered from the insurers shall be borne by the Employer or the Contractor in accordance with their responsibilities under Clause 20.</p>
Exclusions	21.4	<p>There shall be no obligation for the insurances in Sub-Clause 21.1 to include loss or damage caused by:</p> <p>(a) war, hostilities (whether war be declared or not), invasion, act of foreign enemies,</p> <p>(b) rebellion, revolution, insurrection, or military or usurped power, or civil war,</p> <p>(c) ionising radiations, or contamination by radio-activity from any nuclear fuel, or from any nuclear waste from the combustion of nuclear fuel, radio-active toxic explosive or other hazardous properties of any explosive nuclear assembly or nuclear component thereof, or</p> <p>(d) pressure waves caused by aircraft or other aerial devices travelling at sonic or supersonic speeds.</p>
Damage to Persons and Property	22.1	<p>The Contractor shall, except if and so far as the Contract provides otherwise, indemnify the Employer against all losses and claims in respect of:</p> <p>(a) death of or injury to any person, or</p> <p>(b) loss of or damage to any property (other than the Works),</p> <p>which may arise out of or in consequence of the execution and completion of the Works and the remedying of any defects therein, and against all claims, proceedings, damages, costs, charges and expenses whatsoever in respect thereof or in relation thereto, subject to the exceptions defined in Sub-Clause 22.2.</p>
Exceptions	22.2	<p>The “exceptions” referred to in Sub-Clause 22.1 are:</p> <p>(a) the permanent use or occupation of land by the Works, or any part thereof,</p> <p>(b) the right of the Employer to execute the Works, or any part thereof, on, over, under, in or through any land,</p> <p>(c) damage to property which is the unavoidable result of the execution and completion of the Works, or the remedying of any defects therein, in accordance with the Contract, and</p> <p>(d) death of or injury to persons or loss of or damage to property resulting from any act or neglect of the Employer, his agents, servants or other contractors, not being employed by the Contractor, or in respect of any claims, proceedings, damages, costs, charges and expenses in respect thereof or in relation thereto, where the injury or damage was contributed to by the Contractor, his servants or agents, such part of the said injury or damage as may be just and equitable having regard to the extent of the responsibility of the Employer, his servants or agents or other contractors for the injury or damage.</p>

Indemnity by Employer	22.3	The Employer shall indemnify the Contractor against all claims, proceedings, damages, costs, charges and expenses in respect of the matters referred to in the exceptions defined in Sub-Clause 22.2.
Third Party Insurance (including Employer's Property)	23.1	The Contractor shall, without limiting his or the Employer's obligations and responsibilities under Clause 22, insure, in the joint names of the Contractor and the Employer, against liabilities for death of or injury to any person (other than as provided in Clause 24) or loss of or damage to any property (other than the Works) arising out of the performance of the Contract, other than the exceptions defined in paragraphs (a), (b) and (c) of Sub-Clause 22.2.
Minimum Amount of Insurance	23.2	Such insurance shall be for at least the amount stated in the Appendix to Tender.
Cross Liabilities	23.3	The insurance policy shall include a cross liability clause such that the insurance shall apply to the Contractor and to the Employer as separate insureds.
Accident or Injury to Workmen	24.1	The Employer shall not be liable for or in respect of any damages or compensation payable to any workman or other person in the employment of the Contractor or any Subcontractor, other than death or injury resulting from any act or default of the Employer, his agents or servants. The Contractor shall indemnify and keep indemnified the Employer against all such damages and compensation, other than those for which the Employer is liable as aforesaid, and against all claims, proceedings, damages, costs, charges, and expenses whatsoever in respect thereof or in relation thereto.
Insurance Against Accident to Workmen	24.2	The Contractor shall insure against such liability and shall continue such insurance during the whole of the time that any persons are employed by him on the Works. Provided that, in respect of any persons employed by any Subcontractor, the Contractor's obligations to insure as aforesaid under this Sub-Clause shall be satisfied if the Subcontractor shall have insured against the liability in respect of such persons in such manner that the Employer is indemnified under the policy, but the Contractor shall require such Subcontractor to produce to the Employer, when required, such policy of insurance and the receipt for the payment of the current premium.
Evidence and Terms of Insurances	25.1	The Contractor shall provide evidence to the Employer prior to the start of work at the Site that the insurances required under the Contract have been effected and shall, within 84 days of the Commencement Date, provide the insurance policies to the Employer. When providing such evidence and such policies to the Employer, the Contractor shall notify the Engineer of so doing. Such insurance policies shall be consistent with the general terms agreed prior to the issue of the Letter of Acceptance. The Contractor shall effect all insurances for which he is responsible with insurers and in terms approved by the Employer.
Adequacy of Insurances	25.2	The Contractor shall notify the insurers of changes in the nature, extent or programme for the execution of the Works and ensure the adequacy of the insurances at all times in accordance with the terms of the Contract and shall, when required, produce to the Employer the insurance policies in force and the receipts for payment of the current premiums.
Remedy on Contractor's Failure to Insure	25.3	If the Contractor fails to effect and keep in force any of the insurances required under the Contract, or fails to provide the policies to the Employer within the period required by Sub-Clause 25.1, then and in any such case the Employer may effect and keep in force any such insurances and pay any premium as may be necessary for that purpose and from time to time deduct the amount so paid from any monies due or to become due to the Contractor, or recover the same as a debt due from the Contractor.
Compliance with Policy Conditions	25.4	In the event that the Contractor or the Employer fails to comply with conditions imposed by the insurance policies effected pursuant to the Contract, each shall indemnify the other against all losses and claims arising from such failure.

- Compliance with Statutes, Regulations** **26.1** The Contractor shall conform in all respects, including by the giving of all notices and the paying of all fees, with the provisions of:
- (a) any National or State Statute, Ordinance, or other Law, or any regulation, or bye-law of any local or other duly constituted authority in relation to the execution and completion of the Works and the remedying of any defects therein, and
 - (b) the rules and regulations of all public bodies and companies whose property or rights are affected or may be affected in any way by the Works,
- and the Contractor shall keep the Employer indemnified against all penalties and liability of every kind for breach of any such provisions. Provided always that the Employer shall be responsible for obtaining any planning, zoning or other similar permission required for the Works to proceed and shall indemnify the Contractor in accordance with Sub-Clause 22.3.
- Fossils** **27.1** All fossils, coins, articles of value or antiquity and structures and other remains or things of geological or archaeological interest discovered on the Site shall, as between the Employer and the Contractor, be deemed to be the absolute property of the Employer. The Contractor shall take reasonable precautions to prevent his workmen or any other persons from removing or damaging any such article or thing and shall, immediately upon discovery thereof and before removal, acquaint the Engineer of such discovery and carry out the Engineer's instructions for dealing with the same. If, by reason of such instructions, the Contractor suffers delay and/or incurs costs then the Engineer shall, after due consultation with the Employer and the Contractor, determine:
- (a) any extension of time to which the Contractor is entitled under Clause 44, and
 - (b) the amount of such costs, which shall be added to the Contract Price, and shall notify the Contractor accordingly, with a copy to the Employer.
- Patent Rights** **28.1** The Contractor shall save harmless and indemnify the Employer from and against all claims and proceedings for or on account of infringement of any patent rights, design trademark or name or other protected rights in respect of any Contractor's Equipment, materials or Plant used for or in connection with or for incorporation in the Works and from and against all damages, costs, charges and expenses whatsoever in respect thereof or in relation thereto, except where such infringement results from compliance with the design or Specification provided by the Engineer.
- Royalties** **28.2** Except where otherwise stated, the Contractor shall pay all tonnage and other royalties, rent and other payments or compensation, if any, for getting stone, sand, gravel, clay or other materials required for the Works.
- Interference with Traffic and Adjoining Properties** **29.1** All operations necessary for the execution and completion of the Works and the remedying of any defects therein shall, so far as compliance with the requirements of the Contract permits, be carried on so as not to interfere unnecessarily or improperly with:
- (a) the convenience of the public, or
 - (b) the access to, use and occupation of public or private roads and footpaths to or of properties whether in the possession of the Employer or of any other person.
- The Contractor shall save harmless and indemnify the Employer in respect of all claims, proceedings, damages, costs, charges and expenses whatsoever arising out of, or in relation to, any such matters insofar as the Contractor is responsible therefor.

- Avoidance of Damage to Roads** **30.1** The Contractor shall use every reasonable means to prevent any of the roads or bridges communicating with or on the routes to the Site from being damaged or injured by any traffic of the Contractor or any of his Subcontractors and, in particular, shall select routes, choose and use vehicles and restrict and distribute loads so that any such extraordinary traffic as will inevitably arise from the moving of materials, Plant, Contractor's Equipment or Temporary Works from and to the Site shall be limited, as far as reasonably possible, and so that no unnecessary damage or injury may be occasioned to such roads and bridges.
- Transport of Contractor's Equipment or Temporary Works** **30.2** Save insofar as the Contract otherwise provides, the Contractor shall be responsible for and shall pay the cost of strengthening any bridges or altering or improving any road communicating with or on the routes to the Site to facilitate the movement of Contractor's Equipment or Temporary Works and the Contractor shall indemnify and keep indemnified the Employer against all claims for damage to any such road or bridge caused by such movement, including such claims as may be made directly against the Employer, and shall negotiate and pay all claims arising solely out of such damage.
- Transport of Materials or Plant** **30.3** If, notwithstanding Sub-Clause 30.1, any damage occurs to any bridge or road communicating with or on the routes to the Site arising from the transport of materials or Plant, the Contractor shall notify the Engineer with a copy to the Employer, as soon as he becomes aware of such damage or as soon as he receives any claim from the authority entitled to make such claim. Where under any law or regulation the haulier of such materials or Plant is required to indemnify the road authority against damage the Employer shall not be liable for any costs, charges or expenses in respect thereof or in relation thereto. In other cases the Employer shall negotiate the settlement of and pay all sums due in respect of such claim and shall indemnify the Contractor in respect thereof and in respect of all claims, proceedings, damages, costs, charges and expenses in relation thereto. Provided that if and so far as any such claim or part thereof is, in the opinion of the Engineer, due to any failure on the part of the Contractor to observe and perform his obligations under Sub-Clause 30.1, then the amount, determined by the Engineer, after due consultation with the Employer and the Contractor, to be due to such failure shall be recoverable from the Contractor by the Employer and may be deducted by the Employer from any monies due or to become due to the Contractor and the Engineer shall notify the Contractor accordingly, with a copy to the Employer. Provided also that the Employer shall notify the Contractor whenever a settlement is to be negotiated and, where any amount may be due from the Contractor, the Employer shall consult with the Contractor before such settlement is agreed.
- Waterborne Traffic** **30.4** Where the nature of the Works is such as to require the use by the Contractor of waterborne transport the foregoing provisions of this Clause shall be construed as though "road" included a lock, dock, sea wall or other structure related to a waterway and "vehicle" included craft, and shall have effect accordingly.
- Opportunities for Other Contractors** **31.1** The Contractor shall, in accordance with the requirements of the Engineer, afford all reasonable opportunities for carrying out their work to:
- (a) any other contractors employed by the Employer and their workmen,
 - (b) the workmen of the Employer, and
 - (c) the workmen of any duly constituted authorities who may be employed in the execution on or near the Site of any work not included in the Contract or of any contract which the Employer may enter into in connection with or ancillary to the Works.
- Facilities for Other Contractors** **31.2** If, however, pursuant to Sub-Clause 31.1 the Contractor shall, on the written request of the Engineer:
- (a) make available to any such other contractor, or to the Employer or any such authority, any roads or ways for the maintenance of which the Contractor is responsible,

(b) permit the use, by any such, of Temporary Works or Contractor's Equipment on the Site, or

(c) provide any other service of whatsoever nature for any such,

the Engineer shall determine an addition to the Contract Price in accordance with Clause 52 and shall notify the Contractor accordingly, with a copy to the Employer.

- Contractor to Keep Site Clear** **32.1** During the execution of the Works the Contractor shall keep the Site reasonably free from all unnecessary obstruction and shall store or dispose of any Contractor's Equipment and surplus materials and clear away and remove from the Site any wreckage, rubbish or Temporary Works no longer required.
- Clearance of Site on Completion** **33.1** Upon the issue of any Taking-Over Certificate the Contractor shall clear away and remove from that part of the Site to which such Taking-Over Certificate relates all Contractor's Equipment, surplus material, rubbish and Temporary Works of every kind, and leave such part of the Site and Works clean and in a workmanlike condition to the satisfaction of the Engineer. Provided that the Contractor shall be entitled to retain on Site, until the end of the Defects Liability Period, such materials, Contractor's Equipment and Temporary Works as are required by him for the purpose of fulfilling his obligations during the Defects Liability Period.

Labour

- Engagement of Staff and Labour** **34.1** The Contractor shall, unless otherwise provided in the Contract, make his own arrangements for the engagement of all staff and labour, local or other, and for their payment, housing, feeding and transport.
- Returns of Labour and Contractor's Equipment** **35.1** The Contractor shall, if required by the Engineer, deliver to the Engineer a return in detail, in such form and at such intervals as the Engineer may prescribe, showing the staff and the numbers of the several classes of labour from time to time employed by the Contractor on the Site and such information respecting Contractor's Equipment as the Engineer may require.

Materials, Plant and Workmanship

- Quality of Materials, Plant and Workmanship** **36.1** All materials, Plant and workmanship shall be:
- (a) of the respective kinds described in the Contract and in accordance with the Engineer's instructions, and
 - (b) subjected from time to time to such tests as the Engineer may require at the place of manufacture, fabrication or preparation, or on the Site or at such other place or places as may be specified in the Contract, or at all or any of such places.
- The Contractor shall provide such assistance, labour, electricity, fuels, stores, apparatus and instruments as are normally required for examining, measuring and testing any materials or Plant and shall supply samples of materials, before incorporation in the Works, for testing as may be selected and required by the Engineer.
- Cost of Samples** **36.2** All samples shall be supplied by the Contractor at his own cost if the supply thereof is clearly intended by or provided for in the Contract.
- Cost of Tests** **36.3** The cost of making any test shall be borne by the Contractor if such test is:
- (a) clearly intended by or provided for in the Contract, or
 - (b) particularised in the Contract (in cases only of a test under load or of a test to ascertain whether the design of any finished or partially finished work is appropriate for the purposes which it was intended to fulfil) in sufficient detail to enable the Contractor to price or allow for the same in his Tender.

Cost of Tests not Provided for	36.4	<p>If any test required by the Engineer which is:</p> <p>(a) not so intended by or provided for,</p> <p>(b) (in the cases above mentioned) not so particularised, or</p> <p>(c) (though so intended or provided for) required by the Engineer to be carried out at any place other than the Site or the place of manufacture, fabrication or preparation of the materials or Plant tested,</p> <p>shows the materials, Plant or workmanship not to be in accordance with the provisions of the Contract to the satisfaction of the Engineer, then the cost of such test shall be borne by the Contractor, but in any other case Sub-Clause 36.5 shall apply.</p>
Engineer's Determination where Tests not Provided for	36.5	<p>Where, pursuant to Sub-Clause 36.4, this Sub-Clause applies the Engineer shall, after due consultation with the Employer and the Contractor, determine:</p> <p>(a) any extension of time to which the Contractor is entitled under Clause 44, and</p> <p>(b) the amount of such costs, which shall be added to the Contract Price,</p> <p>and shall notify the Contractor accordingly, with a copy to the Employer.</p>
Inspection of Operations	37.1	<p>The Engineer, and any person authorised by him, shall at all reasonable times have access to the Site and to all workshops and places where materials or Plant are being manufactured, fabricated or prepared for the Works and the Contractor shall afford every facility for and every assistance in obtaining the right to such access.</p>
Inspection and Testing	37.2	<p>The Engineer shall be entitled, during manufacture, fabrication or preparation to inspect and test the materials and Plant to be supplied under the Contract. If materials or Plant are being manufactured, fabricated or prepared in workshops or places other than those of the Contractor, the Contractor shall obtain permission for the Engineer to carry out such inspection and testing in those workshops or places. Such inspection or testing shall not release the Contractor from any obligation under the Contract.</p>
Dates for Inspection and Testing	37.3	<p>The Contractor shall agree with the Engineer on the time and place for the inspection or testing of any materials or Plant as provided in the Contract. The Engineer shall give the Contractor not less than 24 hours notice of his intention to carry out the inspection or to attend the tests. If the Engineer, or his duly authorised representative, does not attend on the date agreed, the Contractor may, unless otherwise instructed by the Engineer, proceed with the tests, which shall be deemed to have been made in the presence of the Engineer. The Contractor shall forthwith forward to the Engineer duly certified copies of the test readings. If the Engineer has not attended the tests, he shall accept the said readings as accurate.</p>
Rejection	37.4	<p>If, at the time and place agreed in accordance with Sub-Clause 37.3, the materials or Plant are not ready for inspection or testing or if, as a result of the inspection or testing referred to in this Clause, the Engineer determines that the materials or Plant are defective or otherwise not in accordance with the Contract, he may reject the materials or Plant and shall notify the Contractor thereof immediately. The notice shall state the Engineer's objections with reasons. The Contractor shall then promptly make good the defect or ensure that rejected materials or Plant comply with the Contract. If the Engineer so requests, the tests of rejected materials or Plant shall be made or repeated under the same terms and conditions. All costs incurred by the Employer by the repetition of the tests shall, after due consultation with the Employer and the Contractor, be determined by the Engineer and shall be recoverable from the Contractor by the Employer and may be deducted from any monies due or to become due to the Contractor and the Engineer shall notify the Contractor accordingly, with a copy to the Employer.</p>

Independent Inspection	37.5	The Engineer may delegate inspection and testing of materials or Plant to an independent inspector. Any such delegation shall be effected in accordance with Sub-Clause 2.4 and for this purpose such independent inspector shall be considered as an assistant of the Engineer. Notice of such appointment (not being less than 14 days) shall be given by the Engineer to the Contractor.
Examination of Work before Covering up	38.1	No part of the Works shall be covered up or put out of view without the approval of the Engineer and the Contractor shall afford full opportunity for the Engineer to examine and measure any such part of the Works which is about to be covered up or put out of view and to examine foundations before any part of the Works is placed thereon. The Contractor shall give notice to the Engineer whenever any such part of the Works or foundations is or are ready or about to be ready for examination and the Engineer shall, without unreasonable delay, unless he considers it unnecessary and advises the Contractor accordingly, attend for the purpose of examining and measuring such part of the Works or of examining such foundations.
Uncovering and Making Openings	38.2	The Contractor shall uncover any part of the Works or make openings in or through the same as the Engineer may from time to time instruct and shall reinstate and make good such part. If any such part has been covered up or put out of view after compliance with the requirement of Sub-Clause 38.1 and is found to be executed in accordance with the Contract, the Engineer shall, after due consultation with the Employer and the Contractor, determine the amount of the Contractor's costs in respect of such of uncovering, making openings in or through, reinstating and making good the same, which shall be added to the Contract Price, and shall notify the Contractor accordingly, with a copy to the Employer. In any other case all costs shall be borne by the Contractor.
Removal of Improper Work, Materials or Plant	39.1	<p>The Engineer shall have authority to issue instructions from time to time, for:</p> <p>(a) the removal from the Site, within such time or times as may be specified in the instruction, of any materials or Plant which, in the opinion of the Engineer, are not in accordance with the Contract,</p> <p>(b) the substitution of proper and suitable materials or Plant, and</p> <p>(c) the removal and proper re-execution, notwithstanding any previous test thereof or interim payment therefor, of any work which, in respect of</p> <p style="padding-left: 40px;">(i) materials, Plant or workmanship, or</p> <p style="padding-left: 40px;">(ii) design by the Contractor or for which he is responsible,</p> <p>is not, in the opinion of the Engineer, in accordance with the Contract.</p>
Default of Contractor in Compliance	39.2	In case of default on the part of the Contractor in carrying out such instruction within the time specified therein or, if none, within a reasonable time, the Employer shall be entitled to employ and pay other persons to carry out the same and all costs consequent thereon or incidental thereto shall, after due consultation with the Employer and the Contractor, be determined by the Engineer and shall be recoverable from the Contractor by the Employer, and may be deducted by the Employer from any monies due or to become due to the Contractor and the Engineer shall notify the Contractor accordingly, with a copy to the Employer.

Suspension

Suspension of Work	40.1	<p>The Contractor shall, on the instructions of the Engineer, suspend the progress of the Works or any part thereof for such time and in such manner as the Engineer may consider necessary and shall, during such suspension, properly protect and secure the Works or such part thereof so far as is necessary in the opinion of the Engineer. Unless such suspension is:</p> <p>(a) otherwise provided for in the Contract,</p> <p>(b) necessary by reason of some default of or breach of contract by the Contractor or for which he is responsible,</p>
---------------------------	-------------	--

(c) necessary by reason of climatic conditions on the Site, or

(d) necessary for the proper execution of the Works or for the safety of the Works or any part thereof (save to the extent that such necessity arises from any act or default by the Engineer or the Employer or from any of the risks defined in Sub-Clause 20.4),

Sub-Clause 40.2 shall apply.

Engineer's Determination following Suspension **40.2** Where, pursuant to Sub-Clause 40.1, this Sub-Clause applies the Engineer shall, after due consultation with the Employer and the Contractor, determine:

(a) any extension of time to which the Contractor is entitled under Clause 44, and

(b) the amount, which shall be added to the Contract Price, in respect of the cost incurred by the Contractor by reason of such suspension,

and shall notify the Contractor accordingly, with a copy to the Employer.

Suspension lasting more than 84 Days **40.3** If the progress of the Works or any part thereof is suspended on the instructions of the Engineer and if permission to resume work is not given by the Engineer within a period of 84 days from the date of suspension then, unless such suspension is within paragraph (a), (b), (c) or (d) of Sub-Clause 40.1, the Contractor may give notice to the Engineer requiring permission, within 28 days from the receipt thereof, to proceed with the Works or that part thereof in regard to which progress is suspended. If, within the said time, such permission is not granted, the Contractor may, but is not bound to, elect to treat the suspension, where it affects part only of the Works, as an omission of such part under Clause 51 by giving a further notice to the Engineer to that effect, or, where it affects the whole of the Works, treat the suspension as an event of default by the Employer and terminate his employment under the Contract in accordance with the provisions of Sub-Clause 69.1, whereupon the provisions of Sub-Clauses 69.2 and 69.3 shall apply.

Commencement and Delays

Commencement of Works **41.1** The Contractor shall commence the Works as soon as is reasonably possible after the receipt by him of a notice to this effect from the Engineer, which notice shall be issued within the time stated in the Appendix to Tender after the date of the Letter of Acceptance. Thereafter, the Contractor shall proceed with the Works with due expedition and without delay.

Possession of Site and Access Thereto **42.1** Save insofar as the Contract may prescribe:

(a) the extent of portions of the Site of which the Contractor is to be given possession from time to time,

(b) the order in which such portions shall be made available to the Contractor,

and, subject to any requirement in the Contract as to the order in which the Works shall be executed, the Employer will, with the Engineer's notice to commence the Works, give to the Contractor possession of

(c) so much of the Site, and

(d) such access as, in accordance with the Contract, is to be provided by the Employer as may be required to enable the Contractor to commence and proceed with the execution of the Works in accordance with the programme referred to in Clause 14, if any, and otherwise in accordance with such reasonable proposals as the Contractor shall, by notice to the Engineer with a copy to the Employer, make. The Employer will, from time to time as the Works proceed, give to the Contractor possession of such further portions of the Site as may be required to enable the Contractor to proceed with the execution of the Works with due dispatch in accordance with such programme or proposals, as the case may be.

Failure to Give Possession	42.2	<p>If the Contractor suffers delay and/or incurs costs from failure on the part of the Employer to give possession in accordance with the terms of Sub-Clause 42. 1, the Engineer shall, after due consultation with the Employer and the Contractor, determine:</p> <p>(a) any extension of time to which the Contractor is entitled under Clause 44, and</p> <p>(b) the amount of such costs, which shall be added to the Contract Price, and shall notify the Contractor accordingly, with a copy to the Employer.</p>
Rights of Way and Facilities	42.3	<p>The Contractor shall bear all costs and charges for special or temporary rights of way required by him in connection with access to the Site. The Contractor shall also provide at his own cost any additional facilities outside the Site required by him for the purposes of the Works.</p>
Time for Completion	43.1	<p>The whole of the Works and, if applicable, any Section required to be completed within a particular time as stated in the Appendix to Tender, shall be completed, in accordance with the provisions of Clause 48, within the time stated in the Appendix to Tender for the whole of the Works or the Section (as the case may be), calculated from the Commencement Date, or such extended time as may be allowed under Clause 44.</p>
Extension of Time for Completion	44.1	<p>In the event of:</p> <p>(a) the amount or nature of extra or additional work,</p> <p>(b) any cause of delay referred to in these Conditions,</p> <p>(c) exceptionally adverse climatic conditions,</p> <p>(d) any delay, impediment or prevention by the Employer, or</p> <p>(e) other special circumstances which may occur, other than through a default of or breach of contract by the Contractor or for which he is responsible,</p> <p>being such as fairly to entitle the Contractor to an extension of the Time for Completion of the Works, or any Section or part thereof, the Engineer shall, after due consultation with the Employer and the Contractor, determine the amount of such extension and shall notify the Contractor accordingly, with a copy to the Employer.</p>
Contractor to Provide Notification and Detailed Particulars	44.2	<p>Provided that the Engineer is not bound to make any determination unless the Contractor has</p> <p>(a) within 28 days after such event has first arisen notified the Engineer with a copy to the Employer, and</p> <p>(b) within 28 days, or such other reasonable time as may be agreed by the Engineer, after such notification submitted to the Engineer detailed particulars of any extension of time to which he may consider himself entitled in order that such submission may be investigated at the time.</p>
Interim Determination of Extension	44.3	<p>Provided also that where an event has a continuing effect such that it is not practicable for the Contractor to submit detailed particulars within the period of 28 days referred to in Sub-Clause 44.2(b), he shall nevertheless be entitled to an extension of time provided that he has submitted to the Engineer interim particulars at intervals of not more than 28 days and final particulars within 28 days of the end of the effects resulting from the event. On receipt of such interim particulars, the Engineer shall, without undue delay, make an interim determination of extension of time and, on receipt of the final particulars, the Engineer shall review all the circumstances and shall determine an overall extension of time in regard to the event. In both such cases the Engineer shall make his determination after due consultation with the Employer and the Contractor and shall notify the Contractor of the determination, with a copy to the Employer. No final review shall result in a decrease of any extension of time already determined by the Engineer.</p>

Restriction on Working Hours

45.1 Subject to any provision to the contrary contained in the Contract, none of the Works shall, save as hereinafter provided, be carried on during the night or on locally recognised days of rest without the consent of the Engineer, except when work is unavoidable or absolutely necessary for the saving of life or property or for the safety of the Works, in which case the Contractor shall immediately advise the Engineer. Provided that the provisions of this Clause shall not be applicable in the case of any work which it is customary to carry out by multiple shifts.

Rate of Progress

46.1 If for any reason, which does not entitle the Contractor to an extension of time, the rate of progress of the Works or any Section is at any time, in the opinion of the Engineer, too slow to comply with the Time for Completion, the Engineer shall so notify the Contractor who shall thereupon take such steps as are necessary, subject to the consent of the Engineer, to expedite progress so as to comply with the Time for Completion. The Contractor shall not be entitled to any additional payment for taking such steps. If, as a result of any notice given by the Engineer under this Clause, the Contractor considers that it is necessary to do any work at night or on locally recognised days of rest, he shall be entitled to seek the consent of the Engineer so to do. Provided that if any steps, taken by the Contractor in meeting his obligations under this Clause, involve the Employer in additional supervision costs, such costs shall, after due consultation with the Employer and the Contractor, be determined by the Engineer and shall be recoverable from the Contractor by the Employer, and may be deducted by the Employer from any monies due or to become due to the Contractor and the Engineer shall notify the Contractor accordingly, with a copy to the Employer.

Liquidated Damages for Delay

47.1 If the Contractor fails to comply with the Time for Completion in accordance with Clause 48, for the whole of the Works or, if applicable, any Section within the relevant time prescribed by Clause 43, then the Contractor shall pay to the Employer the relevant sum stated in the Appendix to Tender as liquidated damages for such default and not as a penalty (which sum shall be the only monies due from the Contractor for such default) for every day or part of a day which shall elapse between the relevant Time for Completion and the date stated in a Taking-Over Certificate of the whole of the Works or the relevant Section, subject to the applicable limit stated in the Appendix to Tender. The Employer may, without prejudice to any other method of recovery, deduct the amount of such damages from any monies due or to become due to the Contractor. The payment or deduction of such damages shall not relieve the Contractor from his obligation to complete the Works, or from any other of his obligations and liabilities under the Contract.

Reduction of Liquidated Damages

47.2 If, before the Time for Completion of the whole of the Works or, if applicable, any Section, a Taking-Over Certificate has been issued for any part of the Works or of a Section, the liquidated damages for delay in completion of the remainder of the Works or of that Section shall, for any period of delay after the date stated in such Taking-Over Certificate, and in the absence of alternative provisions in the Contract, be reduced in the proportion which the value of the part so certified bears to the value of the whole of the Works or Section, as applicable. The provisions of this Sub-Clause shall only apply to the rate of liquidated damages and shall not affect the limit thereof.

Taking-Over Certificate 48.1 When the whole of the Works have been substantially completed and have satisfactorily passed any Tests on Completion prescribed by the Contract, the Contractor may give a notice to that effect to the Engineer, with a copy to the Employer, accompanied by a written undertaking to finish with due expedition any outstanding work during the Defects Liability Period. Such notice and undertaking shall be deemed to be a request by the Contractor for the Engineer to issue a Taking-Over Certificate in respect of the Works. The Engineer shall, within 21 days of the date of delivery of such notice, either issue to the Contractor, with a copy to the Employer, a Taking-Over Certificate, stating the date on which, in his opinion, the Works were substantially completed in accordance with the Contract, or give instructions in writing to the Contractor specifying all the work which, in the Engineer's opinion, is required to be done by the Contractor before the issue of such Certificate. The Engineer shall also notify the Contractor of any defects in the Works affecting substantial completion that may appear after such instructions and before completion of the Works specified therein. The Contractor shall be entitled to receive such Taking-Over Certificate within 21 days of completion, to the satisfaction of the Engineer, of the Works so specified and remedying any defects so notified.

Taking Over of Sections or Parts 48.2 Similarly, in accordance with the procedure set out in Sub-Clause 48.1, the Contractor may request and the Engineer shall issue a Taking-Over Certificate in respect of:

(a) any Section in respect of which a separate Time for Completion is provided in the Appendix to Tender,

(b) any substantial part of the Permanent Works which has been both completed to the satisfaction of the Engineer and, otherwise than as provided for in the Contract, occupied or used by the Employer, or

(c) any part of the Permanent Works which the Employer has elected to occupy or use prior to completion (where such prior occupation or use is not provided for in the Contract or has not been agreed by the Contractor as a temporary measure).

Substantial Completion of Parts 48.3 If any part of the Permanent Works has been substantially completed and has satisfactorily passed any Tests on Completion prescribed by the Contract, the Engineer may issue a Taking-Over Certificate in respect of that part of the Permanent Works before completion of the whole of the Works and, upon the issue of such Certificate, the Contractor shall be deemed to have undertaken to complete with due expedition any outstanding work in that part of the Permanent Works during the Defects Liability Period.

Surfaces Requiring Reinstatement 48.4 Provided that a Taking-Over Certificate given in respect of any Section or part of the Permanent Works before completion of the whole of the Works shall not be deemed to certify completion of any ground or surfaces requiring reinstatement, unless such Taking-Over Certificate shall expressly so state.

Defects Liability

Defects Liability Period 49.1 In these Conditions the expression "Defects Liability Period" shall mean the defects liability period named in the Appendix to Tender, calculated from:

(a) the date of completion of the Works certified by the Engineer in accordance with Clause 48, or

(b) in the event of more than one certificate having been issued by the Engineer under Clause 48, the respective dates so certified,

and in relation to the Defects Liability Period the expression "the Works" shall be construed accordingly.

- Completion of Outstanding Work and Remedying Defects** **49.2** To the intent that the Works shall, at or as soon as practicable after the expiration of the Defects Liability Period, be delivered to the Employer in the condition required by the Contract, fair wear and tear excepted, to the satisfaction of the Engineer, the Contractor shall:
- (a) complete the work, if any, outstanding on the date stated in the Taking-Over Certificate as soon as practicable after such date, and
- (b) execute all such work of amendment, reconstruction, and remedying defects, shrinkages or other faults as the Engineer may, during the Defects Liability Period or within 14 days after its expiration, as a result of an inspection made by or on behalf of the Engineer prior to its expiration, instruct the Contractor to execute.
- Cost of Remedying Defects** **49.3** All work referred to in Sub-Clause 49.2 (b) shall be executed by the Contractor at his own cost if the necessity thereof is, in the opinion of the Engineer, due to:
- (a) the use of materials, Plant or workmanship not in accordance with the Contract,
- (b) where the Contractor is responsible for the design of part of the Permanent Works, any fault in such design, or
- (c) the neglect or failure on the part of the Contractor to comply with any obligation, expressed or implied, on the Contractor's part under the Contract.
- If, in the opinion of the Engineer, such necessity is due to any other cause, he shall determine an addition to the Contract Price in accordance with Clause 52 and shall notify the Contractor accordingly, with a copy to the Employer.
- Contractor's Failure to Carry Out Instructions** **49.4** In case of default on the part of the Contractor in carrying out such instruction within a reasonable time, the Employer shall be entitled to employ and pay other persons to carry out the same and if such work is work which, in the opinion of the Engineer, the Contractor was liable to do at his own cost under the Contract, then all costs consequent thereon or incidental thereto shall, after due consultation with the Employer and the Contractor, be determined by the Engineer and shall be recoverable from the Contractor by the Employer, and may be deducted by the Employer from any monies due or to become due to the Contractor and the Engineer shall notify the Contractor accordingly, with a copy to the Employer.
- Contractor to Search** **50.1** If any defect, shrinkage or other fault in the Works appears at any time prior to the end of the Defects Liability Period, the Engineer may instruct the Contractor, with copy to the Employer, to search under the directions of the Engineer for the cause thereof. Unless such defect, shrinkage or other fault is one for which the Contractor is liable under the Contract, the Engineer shall, after due consultation with the Employer and the Contractor, determine the amount in respect of the costs of such search incurred by the Contractor, which shall be added to the Contract Price and shall notify the Contractor accordingly, with a copy to the Employer. If such defect, shrinkage or other fault is one for which the Contractor is liable, the cost of the work carried out in searching as aforesaid shall be borne by the Contractor and he shall in such case remedy such defect, shrinkage or other fault at his own cost in accordance with the provisions of Clause 49.

Alterations, Additions and Omissions

- Variations** **51.1** The Engineer shall make any variation of the form, quality or quantity of the Works or any part thereof that may, in his opinion, be necessary and for that purpose, or if for any other reason it shall, in his opinion, be appropriate, he shall have the authority to instruct the Contractor to do and the Contractor shall do any of the following:
- (a) increase or decrease the quantity of any work included in the Contract,
- (b) omit any such work (but not if the omitted work is to be carried out by the Employer or by another contractor),

- (c) change the character or quality or kind of any such work,
- (d) change the levels, lines, position and dimensions of any part of the Works,
- (e) execute additional work of any kind necessary for the completion of the Works, or
- (f) change any specified sequence or timing of construction of any part of the Works.

No such variation shall in any way vitiate or invalidate the Contract, but the effect, if any, of all such variations shall be valued in accordance with Clause 52. Provided that where the issue of an instruction to vary the Works is necessitated by some default of or breach of contract by the Contractor or for which he is responsible, any additional cost attributable to such default shall be borne by the Contractor.

Instructions for Variations **51.2** The Contractor shall not make any such variation without an instruction of the Engineer. Provided that no instruction shall be required for increase or decrease in the quantity of any work where such increase or decrease is not the result of an instruction given under this Clause, but is the result of the quantities exceeding or being less than those stated in the Bill of Quantities.

Valuation of Variations **52.1** All variations referred to in Clause 51 and any additions to the Contract Price which are required to be determined in accordance with Clause 52 (for the purposes of this Clause referred to as “varied work”), shall be valued at the rates and prices set out in the Contract if, in the opinion of the Engineer, the same shall be applicable. If the Contract does not contain any rates or prices applicable to the varied work, the rates and prices in the Contract shall be used as the basis for valuation so far as may be reasonable, failing which, after due consultation by the Engineer with the Employer and the Contractor, suitable rates or prices shall be agreed upon between the Engineer and the Contractor. In the event of disagreement the Engineer shall fix such rates or prices as are, in his opinion, appropriate and shall notify the Contractor accordingly, with a copy to the Employer. Until such time as rates or prices are agreed or fixed, the Engineer shall determine provisional rates or prices to enable on-account payments to be included in certificates issued in accordance with Clause 60.

Power of Engineer to Fix Rates **52.2** Provided that if the nature or amount of any varied work relative to the nature or amount of the whole of the Works or to any part thereof, is such that, in the opinion of the Engineer, the rate or price contained in the Contract for any item of the Works is, by reason of such varied work, rendered inappropriate or inapplicable, then, after due consultation by the Engineer with the Employer and the Contractor, a suitable rate or price shall be agreed upon between the Engineer and the Contractor. In the event of disagreement the Engineer shall fix such other rate or price as is, in his opinion, appropriate and shall notify the Contractor accordingly, with a copy to the Employer. Until such time as rates or prices are agreed or fixed, the Engineer shall determine provisional rates or prices to enable on-account payments to be included in certificates issued in accordance with Clause 60.

Provided also that no varied work instructed to be done by the Engineer pursuant to Clause 51 shall be valued under Sub-Clause 52.1 or under this Sub-Clause unless, within 14 days of the date of such instruction and, other than in the case of omitted work, before the commencement of the varied work, notice shall have been given either:

- (a) by the Contractor to the Engineer of his intention to claim extra payment or a varied rate or price, or
- (b) by the Engineer to the Contractor of his intention to vary a rate or price.

Variations Exceeding 15 per cent **52.3** If, on the issue of the Taking-Over Certificate for the whole of the Works, it is found that as a result of:

- (a) all varied work valued under Sub-Clauses 52.1 and 52.2, and

(b) all adjustments upon measurement of the estimated quantities set out in the Bill of Quantities, excluding Provisional Sums, dayworks and adjustments of price made under Clause 70,

but not from any other cause, there have been additions to or deductions from the Contract Price which taken together are in excess of 15 per cent of the "Effective Contract Price" (which for the purposes of this Sub-Clause shall mean the Contract Price, excluding Provisional Sums and allowance for dayworks, if any) then and in such event (subject to any action already taken under any other Sub-Clause of this Clause), after due consultation by the Engineer with the Employer and the Contractor, there shall be added to or deducted from the Contract Price such further sum as may be agreed between the Contractor and the Engineer or, failing agreement, determined by the Engineer having regard to the Contractor's Site and general overhead costs of the Contract. The Engineer shall notify the Contractor of any determination made under this Sub-Clause, with a copy to the Employer. Such sum shall be based only on the amount by which such additions or deductions shall be in excess of 15 per cent of the Effective Contract Price.

Daywork 52.4 The Engineer may, if in his opinion it is necessary or desirable, issue an instruction that any varied work shall be executed on a daywork basis. The Contractor shall then be paid for such varied work under the terms set out in the daywork schedule included in the Contract and at the rates and prices affixed thereto by him in the Tender.

The Contractor shall furnish to the Engineer such receipts or other vouchers as may be necessary to prove the amounts paid and, before ordering materials, shall submit to the Engineer quotations for the same for his approval.

In respect of such of the Works executed on a daywork basis, the Contractor shall, during the continuance of such work, deliver each day to the Engineer an exact list in duplicate of the names, occupation and time of all workmen employed on such work and a statement, also in duplicate, showing the description and quantity of all materials and Contractor's Equipment used thereon or therefor other than Contractor's Equipment which is included in the percentage addition in accordance with such daywork schedule. One copy of each list and statement will, if correct, or when agreed, be signed by the Engineer and returned to the Contractor.

At the end of each month the Contractor shall deliver to the Engineer a priced statement of the labour, materials and Contractor's Equipment, except as aforesaid, used and the Contractor shall not be entitled to any payment unless such lists and statements have been fully and punctually rendered. Provided always that if the Engineer considers that for any reason the sending of such lists or statements by the Contractor, in accordance with the foregoing provision, was impracticable he shall nevertheless be entitled to authorise payment for such work, either as daywork, on being satisfied as to the time employed and the labour, materials and Contractor's Equipment used on such work, or at such value therefor as shall, in his opinion, be fair and reasonable.

Procedure for Claims

Notice of Claims 53.1 Notwithstanding any other provision of the Contract, if the Contractor intends to claim any additional payment pursuant to any Clause of these Conditions or otherwise, he shall give notice of his intention to the Engineer, with a copy to the Employer, within 28 days after the event giving rise to the claim has first arisen.

Contemporary Records 53.2 Upon the happening of the event referred to in Sub-Clause 53.1, the Contractor shall keep such contemporary records as may reasonably be necessary to support any claim he may subsequently wish to make. Without necessarily admitting the Employer's liability, the Engineer shall, on receipt of a notice under Sub-Clause 53.1, inspect such contemporary records and may instruct the Contractor to keep

any further contemporary records as are reasonable and may be material to the claim of which notice has been given. The Contractor shall permit the Engineer to inspect all records kept pursuant to this Sub-Clause and shall supply him with copies thereof as and when the Engineer so instructs.

- Substantiation of Claims** 53.3 Within 28 days, or such other reasonable time as may be agreed by the Engineer, of giving notice under Sub-Clause 53.1, the Contractor shall send to the Engineer an account giving detailed particulars of the amount claimed and the grounds upon which the claim is based. Where the event giving rise to the claim has a continuing effect, such account shall be considered to be an interim account and the Contractor shall, at such intervals as the Engineer may reasonably require, send further interim accounts giving the accumulated amount of the claim and any further grounds upon which it is based. In cases where interim accounts are sent to the Engineer, the Contractor shall send a final account within 28 days of the end of the effects resulting from the event. The Contractor shall, if required by the Engineer so to do, copy to the Employer all accounts sent to the Engineer pursuant to this Sub-Clause.
- Failure to Comply** 53.4 If the Contractor fails to comply with any of the provisions of this Clause in respect of any claim which he seeks to make, his entitlement to payment in respect thereof shall not exceed such amount as the Engineer or any arbitrator or arbitrators appointed pursuant to Sub-Clause 67.3 assessing the claim considers to be verified by contemporary records (whether or not such records were brought to the Engineer's notice as required under Sub-Clauses 53.2 and 53.3).
- Payment of Claims** 53.5 The Contractor shall be entitled to have included in any interim payment certified by the Engineer pursuant to Clause 60 such amount in respect of any claim as the Engineer, after due consultation with the Employer and the Contractor, may consider due to the Contractor provided that the Contractor has supplied sufficient particulars to enable the Engineer to determine the amount due. If such particulars are insufficient to substantiate the whole of the claim, the Contractor shall be entitled to payment in respect of such part of the claim as such particulars may substantiate to the satisfaction of the Engineer. The Engineer shall notify the Contractor of any determination made under this Sub-Clause, with a copy to the Employer.

Contractor's Equipment, Temporary Works and Materials

- Contractor's Equipment, Temporary Works and Materials; Exclusive Use for the Works** 54.1 All Contractor's Equipment, Temporary Works and materials provided by the Contractor shall, when brought on to the Site, be deemed to be exclusively intended for the execution of the Works and the Contractor shall not remove the same or any part thereof, except for the purpose of moving it from one part of the Site to another, without the consent of the Engineer. Provided that consent shall not be required for vehicles engaged in transporting any staff, labour, Contractor's Equipment, Temporary Works, Plant or materials to or from the Site.
- Employer not Liable for Damage** 54.2 The Employer shall not at any time be liable, save as mentioned in Clauses 20 and 65, for the loss of or damage to any of the said Contractor's Equipment, Temporary Works or materials.
- Customs Clearance** 54.3 The Employer will use his best endeavours in assisting the Contractor, where required, in obtaining clearance through the Customs of Contractor's Equipment, materials and other things required for the Works.
- Re-export of Contractor's Equipment** 54.4 In respect of any Contractor's Equipment which the Contractor has imported for the purposes of the Works, the Employer will use his best endeavours to assist the Contractor, where required, in procuring any necessary Government consent to the re-export of such Contractor's Equipment by the Contractor upon the removal thereof pursuant to the terms of the Contract.

- Conditions of Hire of Contractor's Equipment** **54.5** With a view to securing, in the event of termination under Clause 63, the continued availability, for the purpose of executing the Works, of any hired Contractor's Equipment, the Contractor shall not bring on to the Site any hired Contractor's Equipment unless there is an agreement for the hire thereof (which agreement shall be deemed not to include an agreement for hire purchase) which contains a provision that the owner thereof will, on request in writing made by the Employer within 7 days after the date on which any termination has become effective, and on the Employer undertaking to pay all hire charges in respect thereof from such date, hire such Contractor's Equipment to the Employer on the same terms in all respects as the same was hired to the Contractor save that the Employer shall be entitled to permit the use thereof by any other contractor employed by him for the purpose of executing and completing the Works and remedying any defects therein, under the terms of the said Clause 63.
- Costs for the Purpose of Clause 63** **54.6** In the event of the Employer entering into any agreement for the hire of Contractor's Equipment pursuant to Sub-Clause 54.5, all sums properly paid by the Employer under the provisions of any such agreement and all costs incurred by him (including stamp duties) in entering into such agreement shall be deemed, for the purpose of Clause 63, to be part of the cost of executing and completing the Works and the remedying of any defects therein.
- Incorporation of Clause in Subcontracts** **54.7** The Contractor shall, where entering into any subcontract for the execution of any part of the Works, incorporate in such subcontract (by reference or otherwise) the provisions of this Clause in relation to Contractor's Equipment, Temporary Works or materials brought on to the Site by the Subcontractor.
- Approval of Materials not Implied** **54.8** The operation of this Clause shall not be deemed to imply any approval by the Engineer of the materials or other matters referred to therein nor shall it prevent the rejection of any such materials at any time by the Engineer.

Measurement

- Quantities** **55.1** The quantities set out in the Bill of Quantities are the estimated quantities for the Works, and they are not to be taken as the actual and correct quantities of the Works to be executed by the Contractor in fulfilment of his obligations under the Contract.
- Works to be Measured** **56.1** The Engineer shall, except as otherwise stated, ascertain and determine by measurement the value of the Works in accordance with the Contract and the Contractor shall be paid that value in accordance with Clause 60. The Engineer shall, when he requires any part of the Works to be measured, give reasonable notice to the Contractor's authorised agent, who shall:
- (a) forthwith attend or send a qualified representative to assist the Engineer in making such measurement, and
 - (b) supply all particulars required by the Engineer.

Should the Contractor not attend, or neglect or omit to send such representative, then the measurement made by the Engineer or approved by him shall be taken to be the correct measurement of such part of the Works. For the purpose of measuring such Permanent Works as are to be measured by records and drawings, the Engineer shall prepare records and drawings as the work proceeds and the Contractor, as and when called upon to do so in writing, shall, within 14 days, attend to examine and agree such records and drawings with the Engineer and shall sign the same when so agreed. If the Contractor does not attend to examine and agree such records and drawings, they shall be taken to be correct. If, after examination of such records and drawings, the Contractor does not agree the same or does not sign the same as agreed, they shall nevertheless be taken to be correct, unless the Contractor, within 14 days of such examination, lodges with the Engineer notice of the respects in which such records and drawings are claimed by him to be incorrect. On receipt of such notice, the Engineer shall review the records and drawings and either confirm or vary them.

Method of Measurement	57.1	The Works shall be measured net, notwithstanding any general or local custom, except where otherwise provided for in the Contract.
Breakdown of Lump Sum Items	57.2	For the purposes of statements submitted in accordance with Sub-Clause 60.1, the Contractor shall submit to the Engineer, within 28 days after the receipt of the Letter of Acceptance, a breakdown for each of the lump sum items contained in the Tender. Such breakdowns shall be subject to the approval of the Engineer.

Provisional Sums

Definition of “Provisional Sum”	58.1	“Provisional Sum” means a sum included in the Contract and so designated in the Bill of Quantities for the execution of any part of the Works or for the supply of goods, materials, Plant or services, or for contingencies, which sum may be used, in whole or in part, or not at all, on the instructions of the Engineer. The Contractor shall be entitled to only such amounts in respect of the work, supply or contingencies to which such Provisional Sums relate as the Engineer shall determine in accordance with this Clause. The Engineer shall notify the Contractor of any determination made under this Sub-Clause, with a copy to the Employer.
Use of Provisional Sums	58.2	In respect of every Provisional Sum the Engineer shall have authority to issue instructions for the execution of work or for the supply of goods, materials, Plant or services by: <ul style="list-style-type: none"> (a) the Contractor, in which case the Contractor shall be entitled to an amount equal to the value thereof determined in accordance with Clause 52, and (b) a nominated Subcontractor, as hereinafter defined, in which case the sum to be paid to the Contractor therefor shall be determined and paid in accordance with Sub-Clause 59.4.
Production of Vouchers	58.3	The Contractor shall produce to the Engineer all quotations, invoices, vouchers and accounts or receipts in connection with expenditure in respect of Provisional Sums, except where work is valued in accordance with rates or prices set out in the Tender.

Nominated Subcontractors

Definition of “Nominated Subcontractors”	59.1	All specialists, merchants, tradesmen and others executing any work or supplying any goods, materials, Plant or services for which Provisional Sums are included in the Contract, who may have been or be nominated or selected or approved by the Employer or the Engineer, and all persons to whom by virtue of the provisions of the Contract the Contractor is required to subcontract shall, in the execution of such work or the supply of such goods, materials, Plant or services, be deemed to be subcontractors to the Contractor and are referred to in this Contract as “nominated Subcontractors”.
Nominated Subcontractors; Objection to Nomination	59.2	The Contractor shall not be required by the Employer or the Engineer, or be deemed to be under any obligation, to employ any nominated Subcontractor against whom the Contractor may raise reasonable objection, or who declines to enter into a subcontract with the Contractor containing provisions: <ul style="list-style-type: none"> (a) that in respect of the work, goods, materials, Plant or services the subject of the subcontract, the nominated Subcontractor will undertake towards the Contractor such obligations and liabilities as will enable the Contractor to discharge his own obligations and liabilities towards the Employer under the terms of the Contract and will save harmless and indemnify the Contractor from and against the same and from all claims, proceedings, damages, costs, charges and expenses whatsoever arising out of or in connection therewith, or arising out of or in connection with any failure to perform such obligations or to fulfil such liabilities, and

(b) that the nominated Subcontractor will save harmless and indemnify the Contractor from and against any negligence by the nominated Subcontractor, his agents, workmen and servants and from and against any misuse by him or them of any Temporary Works provided by the Contractor for the purposes of the Contract and from all claims as aforesaid.

Design Requirements to be Expressly Stated

59.3 If in connection with any Provisional Sum the services to be provided include any matter of design or specification of any part of the Permanent Works or of any Plant to be incorporated therein, such requirement shall be expressly stated in the Contract and shall be included in any nominated Subcontract. The nominated Subcontract shall specify that the nominated Subcontractor providing such services will save harmless and indemnify the Contractor from and against the same and from all claims, proceedings, damages, costs, charges and expenses whatsoever arising out of or in connection with any failure to perform such obligations or to fulfil such liabilities.

Payments to Nominated Subcontractors

59.4 For all work executed or goods, materials, Plant or services supplied by any nominated Subcontractor, the Contractor shall be entitled to:

(a) the actual price paid or due to be paid by the Contractor, on the instructions of the Engineer, and in accordance with the subcontract;

(b) in respect of labour supplied by the Contractor, the sum, if any, entered in the Bill of Quantities or, if instructed by the Engineer pursuant to paragraph (a) of Sub-Clause 58.2, as may be determined in accordance with Clause 52; and

(c) in respect of all other charges and profit, a sum being a percentage rate of the actual price paid or due to be paid calculated, where provision has been made in the Bill of Quantities for a rate to be set against the relevant Provisional Sum, at the rate inserted by the Contractor against that item or, where no such provision has been made, at the rate inserted by the Contractor in the Appendix to Tender and repeated where provision for such is made in a special item provided in the Bill of Quantities for such purpose.

Certification of Payments to Nominated Subcontractors

59.5 Before issuing, under Clause 60, any certificate, which includes any payment in respect of work done or goods, materials, Plant or services supplied by any nominated Subcontractor, the Engineer shall be entitled to demand from the Contractor reasonable proof that all payments, less retentions, included in previous certificates in respect of the work or goods, materials, Plant or services of such nominated Subcontractor have been paid or discharged by the Contractor. If the Contractor fails to supply such proof then, unless the Contractor:

(a) satisfies the Engineer in writing that he has reasonable cause for withholding or refusing to make such payments, and

(b) produces to the Engineer reasonable proof that he has so informed such nominated Subcontractor in writing,

the Employer shall be entitled to pay to such nominated Subcontractor direct, upon the certificate of the Engineer, all payments, less retentions, provided for in the nominated Subcontract, which the Contractor has failed to make to such nominated Subcontractor and to deduct by way of set-off the amount so paid by the Employer from any sums due or to become due from the Employer to the Contractor.

Provided that, where the Engineer has certified and the Employer has paid direct as aforesaid, the Engineer shall, in issuing any further certificate in favour of the Contractor, deduct from the amount thereof the amount so paid, direct as aforesaid, but shall not withhold or delay the issue of the certificate itself when due to be issued under the terms of the Contract.

Certificates and Payment

Monthly Statements

60.1 The Contractor shall submit to the Engineer after the end of each month six copies, each signed by the Contractor's representative approved by the Engineer in accordance with Sub-Clause 15.1, of a statement, in such form as the Engineer may from time to time prescribe, showing the amounts to which the Contractor considers himself to be entitled up to the end of the month in respect of:

- (a) the value of the Permanent Works executed,
- (b) any other items in the Bill of Quantities including those for Contractor's Equipment, Temporary Works, dayworks and the like,
- (c) the percentage of the invoice value of listed materials, all as stated in the Appendix to Tender, and Plant delivered by the Contractor on the Site for incorporation in the Permanent Works but not incorporated in such Works,
- (d) adjustments under Clause 70, and
- (e) any other sum to which the Contractor may be entitled under the Contract or otherwise.

Monthly Payments

60.2 The Engineer shall, within 28 days of receiving such statement, deliver to the Employer an Interim Payment Certificate stating the amount of payment to the Contractor which the Engineer considers due and payable in respect of such statement, subject:

- (a) firstly, to the retention of the amount calculated by applying the Percentage of Retention stated in the Appendix to Tender, to the amount to which the Contractor is entitled under paragraphs (a), (b), (c) and (e) of Sub-Clause 60.1 until the amount so retained reaches the Limit of Retention Money stated in the Appendix to Tender, and
- (b) secondly, to the deduction, other than pursuant to Clause 47, of any sums which may have become due and payable by the Contractor to the Employer.

Provided that the Engineer shall not be bound to certify any payment under this Sub-Clause if the net amount thereof, after all retentions and deductions, would be less than the Minimum Amount of Interim Payment Certificates stated in the Appendix to Tender.

Notwithstanding the terms of this Clause or any other Clause of the Contract no amount will be certified by the Engineer for payment until the performance security, if required under the Contract, has been provided by the Contractor and approved by the Employer.

Payment of Retention Money

60.3 (a) Upon the issue of the Taking-Over Certificate with respect to the whole of the Works, one half of the Retention Money, or upon the issue of a Taking-Over Certificate with respect to a Section or part of the Permanent Works only such proportion thereof as the Engineer determines having regard to the relative value of such Section or part of the Permanent Works, shall be certified by the Engineer for payment to the Contractor.

(b) Upon the expiration of the Defects Liability Period for the Works the other half of the Retention Money shall be certified by the Engineer for payment to the Contractor. Provided that, in the event of different Defects Liability Periods having become applicable to different Sections or parts of the Permanent Works pursuant to Clause 48, the expression "expiration of the Defects Liability Period" shall, for the purposes of this Sub-Clause, be deemed to mean the expiration of the latest of such periods. Provided also that if at such time there shall remain to be executed by the Contractor any work instructed, pursuant to Clauses 49 and 50, in respect of the Works, the Engineer shall be entitled to withhold certification until completion of such work of so much of the balance of the Retention Money as shall, in the opinion of the Engineer, represent the cost of the work remaining to be executed.

Correction of Certificates

60.4 The Engineer may by any Interim Payment Certificate make any correction or modification in any previous Interim Payment Certificate which shall have been issued by him and shall have authority, if any work is not being carried out to his satisfaction, to omit or reduce the value of such work in any Interim Payment Certificate.

Statement at Completion **60.5** Not later than 84 days after the issue of the Taking-Over Certificate in respect of the whole of the Works, the Contractor shall submit to the Engineer six copies of a Statement at Completion with supporting documents showing in detail, in the form approved by the Engineer:

(a) the final value of all work done in accordance with the Contract up to the date stated in such Taking-Over Certificate,

(b) any further sums which the Contractor considers to be due, and

(c) an estimate of amounts which the Contractor considers will become due to him under the Contract.

The estimated amounts shall be shown separately in such Statement at Completion. The Engineer shall certify payment in accordance with Sub-Clause 60.2.

Final Statement **60.6** Not later than 56 days after the issue of the Defects Liability Certificate pursuant to Sub-Clause 62.1, the Contractor shall submit to the Engineer for consideration six copies of a draft final statement with supporting documents showing in detail, in the form approved by the Engineer:

(a) the value of all work done in accordance with the Contract, and

(b) any further sums which the Contractor considers to be due to him under the Contract or otherwise.

If the Engineer disagrees with or cannot verify any part of the draft final statement, the Contractor shall submit such further information as the Engineer may reasonably require and shall make such changes in the draft as may be agreed between them. The Contractor shall then prepare and submit to the Engineer the final statement as agreed (for the purposes of these Conditions referred to as the "Final Statement").

If, following discussions between the Engineer and the Contractor and any changes to the draft final statement which may be agreed between them, it becomes evident that a dispute exists, the Engineer shall deliver to the Employer an Interim Payment Certificate for those parts of the draft final statement, if any, which are not in dispute. The dispute may then be settled in accordance with Clause 67.

Discharge **60.7** Upon submission of the Final Statement, the Contractor shall give to the Employer, with a copy to the Engineer, a written discharge confirming that the total of the Final Statement represents full and final settlement of all monies due to the Contractor arising out of or in respect of the Contract. Provided that such discharge shall become effective only after payment due under the Final Payment Certificate issued pursuant to Sub-Clause 60.8 has been made and the performance security referred to in Sub-Clause 10.1, if any, has been returned to the Contractor.

Final Payment Certificate **60.8** Within 28 days after receipt of the Final Statement, and the written discharge, the Engineer shall issue to the Employer (with a copy to the Contractor) a Final Payment Certificate stating:

(a) the amount which, in the opinion of the Engineer, is finally due under the Contract or otherwise, and

(b) after giving credit to the Employer for all amounts previously paid by the Employer and for all sums to which the Employer is entitled other than under Clause 47, the balance, if any, due from the Employer to the Contractor or from the Contractor to the Employer as the case may be.

Cessation of Employer's Liability **60.9** The Employer shall not be liable to the Contractor for any matter or thing arising out of or in connection with the Contract or execution of the Works, unless the Contractor shall have included a claim in respect thereof in his Final Statement and (except in respect of matters or things arising after the issue of the Taking-Over Certificate in respect of the whole of the Works) in the Statement at Completion referred to in Sub-Clause 60.5.

Time for Payment	60.10	The amount due to the Contractor under any Interim Payment Certificate issued by the Engineer pursuant to this Clause, or to any other term of the Contract, shall, subject to Clause 47, be paid by the Employer to the Contractor within 28 days after such Interim Payment Certificate has been delivered to the Employer, or, in the case of the Final Payment Certificate referred to in Sub-Clause 60.8, within 56 days, after such Final Payment Certificate has been delivered to the Employer. In the event of the failure of the Employer to make payment within the times stated, the Employer shall pay to the Contractor interest at the rate stated in the Appendix to Tender upon all sums unpaid from the date by which the same should have been paid. The provisions of this Sub-Clause are without prejudice to the Contractor's entitlement under Clause 69 or otherwise.
Approval only by Defects Liability Certificate	61.1	Only the Defects Liability Certificate, referred to in Clause 62, shall be deemed to constitute approval of the Works.
Defects Liability Certificate	62.1	The Contract shall not be considered as completed until a Defects Liability Certificate shall have been signed by the Engineer and delivered to the Employer, with a copy to the Contractor, stating the date on which the Contractor shall have completed his obligations to execute and complete the Works and remedy any defects therein to the Engineer's satisfaction. The Defects Liability Certificate shall be given by the Engineer within 28 days after the expiration of the Defects Liability Period, or, if different defects liability periods shall become applicable to different Sections or parts of the Permanent Works, the expiration of the latest such period, or as soon thereafter as any works instructed, pursuant to Clauses 49 and 50, have been completed to the satisfaction of the Engineer. Provided that the issue of the Defects Liability Certificate shall not be a condition precedent to payment to the Contractor of the second portion of the Retention Money in accordance with the conditions set out in Sub-Clause 60.3.
Unfulfilled Obligations	62.2	Notwithstanding the issue of the Defects Liability Certificate the Contractor and the Employer shall remain liable for the fulfilment of any obligation incurred under the provisions of the Contract prior to the issue of the Defects Liability Certificate which remains unperformed at the time such Defects Liability Certificate is issued and, for the purposes of determining the nature and extent of any such obligation, the Contract shall be deemed to remain in force between the parties to the Contract.

Remedies

Default of Contractor	63.1	<p>If the Contractor is deemed by law unable to pay his debts as they fall due, or enters into voluntary or involuntary bankruptcy, liquidation or dissolution (other than a voluntary liquidation for the purposes of amalgamation or reconstruction), or becomes insolvent, or makes an arrangement with, or assignment in favour of, his creditors, or agrees to carry out the Contract under a committee of inspection of his creditors, or if a receiver, administrator, trustee or liquidator is appointed over any substantial part of his assets, or if, under any law or regulation relating to reorganization, arrangement or readjustment of debts, proceedings are commenced against the Contractor or resolutions passed in connection with dissolution or liquidation or if any steps are taken to enforce any security interest over a substantial part of the assets of the Contractor, or if any act is done or event occurs with respect to the Contractor or his assets which, under any applicable law has a substantially similar effect to any of the foregoing acts or events, or if the Contractor has contravened Sub-Clause 3.1, or has an execution levied on his goods, or if the Engineer certifies to the Employer, with a copy to the Contractor, that, in his opinion, the Contractor:</p> <ul style="list-style-type: none"> (a) has repudiated the Contract, (b) without reasonable excuse has failed <ul style="list-style-type: none"> (i) to commence the Works in accordance with Sub-Clause 41.1, or (ii) to proceed with the Works, or any Section thereof, within 28 days after receiving notice pursuant to Sub-Clause 46.1,
------------------------------	-------------	---

(c) has failed to comply with a notice issued pursuant to Sub-Clause 37.4 or an instruction issued pursuant to Sub-Clause 39.1 within 28 days after having received it,

(d) despite previous warning from the Engineer, in writing, is otherwise persistently or flagrantly neglecting to comply with any of his obligations under the Contract, or

(e) has contravened Sub-Clause 4.1,

then the Employer may, after giving 14 days' notice to the Contractor, enter upon the Site and the Works and terminate the employment of the Contractor without thereby releasing the Contractor from any of his obligations or liabilities under the Contract, or affecting the rights and authorities conferred on the Employer or the Engineer by the Contract, and may himself complete the Works or may employ any other contractor to complete the Works. The Employer or such other contractor may use for such completion so much of the Contractor's Equipment, Temporary Works and materials as he or they may think proper.

Valuation at Date of Termination	63.2	<p>The Engineer shall, as soon as may be practicable after any such entry and termination by the Employer, fix and determine ex parte, or by or after reference to the parties or after such investigation or enquiries as he may think fit to make or institute, and shall certify:</p> <p>a) what amount (if any) had, at the time of such entry and termination, been reasonably earned by or would reasonably accrue to the Contractor in respect of work then actually done by him under the Contract, and</p> <p>(b) the value of any of the said unused or partially used materials, any Contractor's Equipment and any Temporary Works.</p>
Payment after Termination	63.3	<p>If the Employer terminates the Contractor's employment under this Clause, he shall not be liable to pay to the Contractor any further amount (including damages) in respect of the Contract until the expiration of the Defects Liability Period and there after until the costs of execution, completion and remedying of any defects, damages for delay in completion (if any) and all other expenses incurred by the Employer have been ascertained and the amount thereof certified by the Engineer. The Contractor shall then be entitled to receive only such sum (if any) as the Engineer may certify would have been payable to him upon due completion by him after deducting the said amount. If such amount exceeds the sum which would have been payable to the Contractor on due completion by him, then the Contractor shall, upon demand, pay to the Employer the amount of such excess and it shall be deemed a debt due by the Contractor to the Employer and shall be recoverable accordingly.</p>
Assignment of Benefit of Agreement	63.4	<p>Unless prohibited by law, the Contractor shall, if so instructed by the Engineer within 14 days of such entry and termination referred to in Sub-Clause 63.1, assign to the Employer the benefit of any agreement for the supply of any goods or materials or services and/or for the execution of any work for the purposes of the Contract, which the Contractor may have entered into.</p>
Urgent Remedial Work	64.1	<p>If, by reason of any accident, or failure, or other event occurring to, in, or in connection with the Works, or any part thereof, either during the execution of the Works, or during the Defects Liability Period, any remedial or other work is, in the opinion of the Engineer, urgently necessary for the safety of the Works and the Contractor is unable or unwilling at once to do such work, the Employer shall be entitled to employ and pay other persons to carry out such work as the Engineer may consider necessary. If the work or repair so done by the Employer is work which, in the opinion of the Engineer, the Contractor was liable to do at his own cost under the Contract, then all costs consequent thereon or incidental thereto shall, after due consultation with the Employer and the Contractor, be determined by the Engineer and shall be recoverable from the Contractor by the Employer, and may be deducted by the Employer from any monies due or to become due to the Contractor and the Engineer shall notify the Contractor accordingly, with a copy to the Employer. Provided that the Engineer shall, as soon after the occurrence of any such emergency as may be reasonably practicable, notify the Contractor thereof.</p>

Special Risks

- No Liability for Special Risks** 65.1 The Contractor shall be under no liability whatsoever in consequence of any of the special risks referred to in Sub-Clause 65.2, whether by way of indemnity or otherwise, for or in respect of:
- (a) destruction of or damage to the Works, save to work condemned under the provisions of Clause 39 prior to the occurrence of any of the said special risks,
 - (b) destruction of or damage to property, whether of the Employer or third parties, or
 - (c) injury or loss of life.
- Special Risks** 65.2 The special risks are:
- (a) the risks defined under paragraphs (a), (c), (d) and (e) of Sub-Clause 20.4, and
 - (b) the risks defined under paragraph (b) of Sub-Clause 20.4 insofar as these relate to the country in which the Works are to be executed.
- Damage to Works by Special Risks** 65.3 If the Works or any materials or Plant on or near or in transit to the Site, or any of the Contractor's Equipment, sustain destruction or damage by reason of any of the said special risks, the Contractor shall be entitled to payment in accordance with the Contract for any Permanent Works duly executed and for any materials or Plant so destroyed or damaged and, so far as may be required by the Engineer or as may be necessary for the completion of the Works, to payment for:
- (a) rectifying any such destruction or damage to the Works, and
 - (b) replacing or rectifying such materials or Contractor's Equipment,
- and the Engineer shall determine an addition to the Contract Price in accordance with Clause 52 (which shall in the case of the cost of replacement of Contractor's Equipment include the fair market value thereof as determined by the Engineer) and shall notify the Contractor accordingly, with a copy to the Employer.
- Projectile, Missile** 65.4 Destruction, damage, injury or loss of life caused by the explosion or impact, whenever and wherever occurring, of any mine, bomb, shell, grenade, or other projectile, missile, munition, or explosive of war, shall be deemed to be a consequence of the said special risks.
- Increased Costs arising from Special Risks** 65.5 Save to the extent that the Contractor is entitled to payment under any other provision of the Contract, the Employer shall repay to the Contractor any costs of the execution of the Works (other than such as may be attributable to the cost of reconstructing work condemned under the provisions of Clause 39 prior to the occurrence of any special risk) which are howsoever attributable to or consequent on or the result of or in any way whatsoever connected with the said special risks, subject however to the provisions in this Clause hereinafter contained in regard to outbreak of war, but the Contractor shall, as soon as any such cost comes to his knowledge, forthwith notify the Engineer thereof. The Engineer shall, after due consultation with the Employer and the Contractor, determine the amount of the Contractor's costs in respect thereof which shall be added to the Contract Price and shall notify the Contractor accordingly, with a copy to the Employer.
- Outbreak of War** 65.6 If, during the currency of the Contract, there is an outbreak of war, whether war is declared or not, in any part of the world which, whether financially or otherwise, materially affects the execution of the Works, the Contractor shall, unless and until the Contract is terminated under the provisions of this Clause, continue to use his best endeavours to complete the execution of the Works. Provided that the Employer shall be entitled, at any time after such outbreak of war, to terminate the Contract by giving notice to the Contractor and, upon such notice being given, the Contract shall, except as to the rights of the parties under this Clause and Clause 67, terminate, but without prejudice to the rights of either party in respect of any antecedent breach thereof.

Removal of Contractor's Equipment on Termination

65.7 If the Contract is terminated under the provisions of Sub-Clause 65.6, the Contractor shall, with all reasonable dispatch, remove from the Site all Contractor's Equipment and shall give similar facilities to his Subcontractors to do so.

Payment if Contract Terminated

65.8 If the Contract is terminated as aforesaid, the Contractor shall be paid by the Employer, insofar as such amounts or items have not already been covered by payments on account made to the Contractor, for all work executed prior to the date of termination at the rates and prices provided in the Contract and in addition:

(a) the amounts payable in respect of any preliminary items referred to in the Bill of Quantities, so far as the work or service comprised therein has been carried out or performed, and a proper proportion of any such items which have been partially carried out or performed;

(b) the cost of materials, Plant or goods reasonably ordered for the Works which have been delivered to the Contractor or of which the Contractor is legally liable to accept delivery, such materials, Plant or goods becoming the property of the Employer upon such payments being made by him;

(c) a sum being the amount of any expenditure reasonably incurred by the Contractor in the expectation of completing the whole of the Works insofar as such expenditure has not been covered by any other payments referred to in this Sub-Clause;

(d) any additional sum payable under the provisions of Sub-Clauses 65.3 and 65.5;

(e) such proportion of the cost as may be reasonable, taking into account payments made or to be made for work executed, of removal of Contractor's Equipment under Sub-Clause 65.7 and, if required by the Contractor, return thereof to the Contractor's main plant yard in his country of registration or to other destination, at no greater cost; and

(f) the reasonable cost of repatriation of all the Contractor's staff and workmen employed on or in connection with the Works at the time of such termination.

Provided that against any payment due from the Employer under this Sub-Clause, the Employer shall be entitled to be credited with any outstanding balances due from the Contractor for advances in respect of Contractor's Equipment, materials and Plant and any other sums which, at the date of termination, were recoverable by the Employer from the Contractor under the terms of the Contract. Any sums payable under this Sub-Clause shall, after due consultation with the Employer and the Contractor, be determined by the Engineer who shall notify the Contractor accordingly, with a copy to the Employer.

Release from Performance

Payment in Event of Release from Performance

66.1 If any circumstance outside the control of both parties arises after the issue of the Letter of Acceptance which renders it impossible or unlawful for either or both parties to fulfil his or their contractual obligations, or under the law governing the Contract the parties are released from further performance, then the parties shall be discharged from the Contract, except as to their rights under this Clause and Clause 67 and without prejudice to the rights of either party in respect of any antecedent breach of the Contract, and the sum payable by the Employer to the Contractor in respect of the work executed shall be the same as that which would have been payable under Clause 65 if the Contract had been terminated under the provisions of Clause 65.

Settlement of Disputes

Engineer's Decision

67.1 If a dispute of any kind whatsoever arises between the Employer and the Contractor in connection with, or arising out of, the Contract or the execution of the Works, whether during the execution of the Works or after their completion and whether before or after repudiation or other termination of the Contract, including any dispute as to any opinion, instruction, determination, certificate or valuation of the Engineer, the matter in dispute shall, in the first place, be referred in writing to the Engineer, with a copy to the other party. Such reference shall state that it is made pursuant to this Clause. No later than the eighty-fourth day after the day on which he received such reference the Engineer shall give notice of his decision to the Employer and the Contractor. Such decision shall state that it is made pursuant to this Clause.

Unless the Contract has already been repudiated or terminated, the Contractor shall, in every case, continue to proceed with the Works with all due diligence and the Contractor and the Employer shall give effect forthwith to every such decision of the Engineer unless and until the same shall be revised, as hereinafter provided, in an amicable settlement or an arbitral award.

If either the Employer or the Contractor be dissatisfied with any decision of the Engineer, or if the Engineer fails to give notice of his decision on or before the eighty-fourth day after the day on which he received the reference, then either the Employer or the Contractor may, on or before the seventieth day after the day on which he received notice of such decision, or on or before the seventieth day after the day on which the said period of 84 days expired, as the case may be, give notice to the other party, with a copy for information to the Engineer, of his intention to commence arbitration, as hereinafter provided, as to the matter in dispute. Such notice shall establish the entitlement of the party giving the same to commence arbitration, as hereinafter provided, as to such dispute and, subject to Sub-Clause 67.4, no arbitration in respect thereof may be commenced unless such notice is given.

If the Engineer has given notice of his decision as to a matter in dispute to the Employer and the Contractor and no notice of intention to commence arbitration as to such dispute has been given by either the Employer or the Contractor on or before the seventieth day after the day on which the parties received notice as to such decision from the Engineer, the said decision shall become final and binding upon the Employer and the Contractor.

Amicable Settlement

67.2 Where notice of intention to commence arbitration as to a dispute has been given in accordance with Sub-Clause 67.1, the parties shall attempt to settle such dispute amicably before the commencement of arbitration. Provided that, unless the parties otherwise agree, arbitration may be commenced on or after the fifty-sixth day after the day on which notice of intention to commence arbitration of such dispute was given, even if no attempt at amicable settlement thereof has been made.

Arbitration

67.3 Any dispute in respect of which:

(a) the decision, if any, of the Engineer has not become final and binding pursuant to Sub-Clause 67.1, and

(b) amicable settlement has not been reached within the period stated in Sub-Clause 67.2,

shall be finally settled, unless otherwise specified in the Contract, under the Rules of Conciliation and Arbitration of the International Chamber of Commerce by one or more arbitrators appointed under such Rules. The said arbitrator/s shall have full power to open up, review and revise any decision, opinion, instruction, determination, certificate or valuation of the Engineer related to the dispute.

Neither party shall be limited in the proceedings before such arbitrator/s to the evidence or arguments put before the Engineer for the purpose of obtaining his said decision pursuant to Sub-Clause 67.1. No such decision shall disqualify the Engineer from being called as a witness and giving evidence before the arbitrator/s on any matter whatsoever relevant to the dispute.

Arbitration may be commenced prior to or after completion of the Works, provided that the obligations of the Employer, the Engineer and the Contractor shall not be altered by reason of the arbitration being conducted during the progress of the Works.

- Failure to Comply with Engineer's Decision** 67.4 Where neither the Employer nor the Contractor has given notice of intention to commence arbitration of a dispute within the period stated in Sub-Clause 67.1 and the related decision has become final and binding, either party may, if the other party fails to comply with such decision, and without prejudice to any other rights it may have, refer the failure to arbitration in accordance with Sub-Clause 67.3. The provisions of Sub-Clauses 67.1 and 67.2 shall not apply to any such reference.

Notices

- Notice to Contractor** 68.1 All certificates, notices or instructions to be given to the Contractor by the Employer or the Engineer under the terms of the Contract shall be sent by post, cable, telex or facsimile transmission to or left at the Contractor's principal place of business or such other address as the Contractor shall nominate for that purpose.
- Notice to Employer and Engineer** 68.2 Any notice to be given to the Employer or to the Engineer under the terms of the Contract shall be sent by post, cable, telex or facsimile transmission to or left at the respective addresses nominated for that purpose in Part II of these Conditions.
- Change of Address** 68.3 Either party may change a nominated address to another address in the country where the Works are being executed by prior notice to the other party, with a copy to the Engineer, and the Engineer may do so by prior notice to both parties.

Default of Employer

- Default of Employer** 69.1 In the event of the Employer:
- (a) failing to pay to the Contractor the amount due under any certificate of the Engineer within 28 days after the expiry of the time stated in Sub-Clause 60.10 within which payment is to be made, subject to any deduction that the Employer is entitled to make under the Contract,
 - (b) interfering with or obstructing or refusing any required approval to the issue of any such certificate,
 - (c) becoming bankrupt or, being a company, going into liquidation, other than for the purpose of a scheme of reconstruction or amalgamation, or
 - (d) giving notice to the Contractor that for unforeseen economic reasons it is impossible for him to continue to meet his contractual obligations,
- the Contractor shall be entitled to terminate his employment under the Contract by giving notice to the Employer, with a copy to the Engineer. Such termination shall take effect 14 days after the giving of the notice.
- Removal of Contractor's Equipment** 69.2 Upon the expiry of the 14 days' notice referred to in Sub-Clause 69.1, the Contractor shall, notwithstanding the provisions of Sub-Clause 54.1, with all reasonable despatch, remove from the Site all Contractor's Equipment brought by him thereon.
- Payment on Termination** 69.3 In the event of such termination the Employer shall be under the same obligations to the Contractor in regard to payment as if the Contract had been terminated under the provisions of Clause 65, but, in addition to the payments specified in Sub-Clause 65.8, the Employer shall pay to the Contractor the amount of any loss or damage to the Contractor arising out of or in connection with or by consequence of such termination.

Contractor's Entitlement to Suspend Work

69.4 Without prejudice to the Contractor's entitlement to interest under Sub-Clause 60.10 and to terminate under Sub-Clause 69.1, the Contractor may, if the Employer fails to pay the Contractor the amount due under any certificate of the Engineer within 28 days after the expiry of the time stated in Sub-Clause 60.10 within which payment is to be made, subject to any deduction that the Employer is entitled to make under the Contract, after giving 28 days' prior notice to the Employer, with a copy to the Engineer, suspend work or reduce the rate of work.

If the Contractor suspends work or reduces the rate of work in accordance with the provisions of this Sub-Clause and thereby suffers delay or incurs costs the Engineer shall, after due consultation with the Employer and the Contractor, determine:

- (a) any extension of time to which the Contractor is entitled under Clause 44, and
 - (b) the amount of such costs, which shall be added to the Contract Price,
- and shall notify the Contractor accordingly, with a copy to the Employer.

Resumption of Work

69.5 Where the Contractor suspends work or reduces the rate of work, having given notice in accordance with Sub-Clause 69.4, and the Employer subsequently pays the amount due, including interest pursuant to Sub-Clause 60.10, the Contractor's entitlement under Sub-Clause 69.1 shall, if notice of termination has not been given, lapse and the Contractor shall resume normal working as soon as is reasonably possible.

Changes in Cost and Legislation

Increase or Decrease of Cost

70.1 There shall be added to or deducted from the Contract Price such sums in respect of rise or fall in the cost of labour and/or materials or any other matters affecting the cost of the execution of the Works as may be determined in accordance with Part II of these Conditions.

Subsequent Legislation

70.2 If, after the date 28 days prior to the latest date for submission of tenders for the Contract there occur in the country in which the Works are being or are to be executed changes to any National or State Statute, Ordinance, Decree or other Law or any regulation or bye-law of any local or other duly constituted authority, or the introduction of any such State Statute, Ordinance, Decree, Law, regulation or bye-law which causes additional or reduced cost to the Contractor, other than under Sub-Clause 70.1, in the execution of the Contract, such additional or reduced cost shall, after due consultation with the Employer and the Contractor, be determined by the Engineer and shall be added to or deducted from the Contract Price- and the Engineer shall notify the Contractor accordingly, with a copy to the Employer.

Currency and Rates of Exchange

Currency Restrictions

71.1 If, after the date 28 days prior to the latest date for submission of tenders for the Contract, the Government or authorised agency of the Government of the country in which the Works are being or are to be executed imposes currency restrictions and/or transfer of currency restrictions in relation to the currency or currencies in which the Contract Price is to be paid, the Employer shall reimburse any loss or damage to the Contractor arising therefrom, without prejudice to the right of the Contractor to exercise any other rights or remedies to which he is entitled in such event.

Rates of Exchange

72.1 Where the Contract provides for payment in whole or in part to be made to the Contractor in foreign currency or currencies, such payment shall not be subject to variations in the rate or rates of exchange between such specified foreign currency or currencies and the currency of the country in which the Works are to be executed.

Currency Proportions

72.2 Where the Employer has required the Tender to be expressed in a single currency but with payment to be made in more than one currency and the Contractor has stated the proportions or amounts of other currency or currencies in which he requires payment to be made, the rate or rates of exchange applicable for calculating the payment of such proportions or amounts shall, unless otherwise stated in Part II of these Conditions, be those prevailing, as determined by the Central Bank of the country in which the Works are to be executed, on the date 28 days prior to the latest date for the submission of tenders for the Contract, as has been notified to the Contractor by the Employer prior to the submission of tenders or as provided for in the Tender.

Currencies of Payment for Provisional Sums

72.3 Where the Contract provides for payment in more than one currency, the proportions or amounts to be paid in foreign currencies in respect of Provisional Sums shall be determined in accordance with the principles set forth in Sub-Clauses 72.1 and 72.2 as and when these sums are utilised in whole or in part in accordance with the provisions of Clauses 58 and 59.

REFERENCE TO PART II

As stated in the Foreword at the beginning of this document, the FIDIC Conditions comprise both Part I and Part II. Certain Clauses, namely Sub-Clauses 1.1 paragraph (a) (i) and (iv), 5.1 (part), 14.1, 14.3, 68.2 and 70.1 must include additional wording in Part II for the Conditions to be complete. Other Clauses may require additional wording to supplement Part I or to cover particular circumstances or the type of work (dredging is an example).

Part II Conditions of Particular Application with guidelines for the preparation of Part II are printed in a separately bound document.

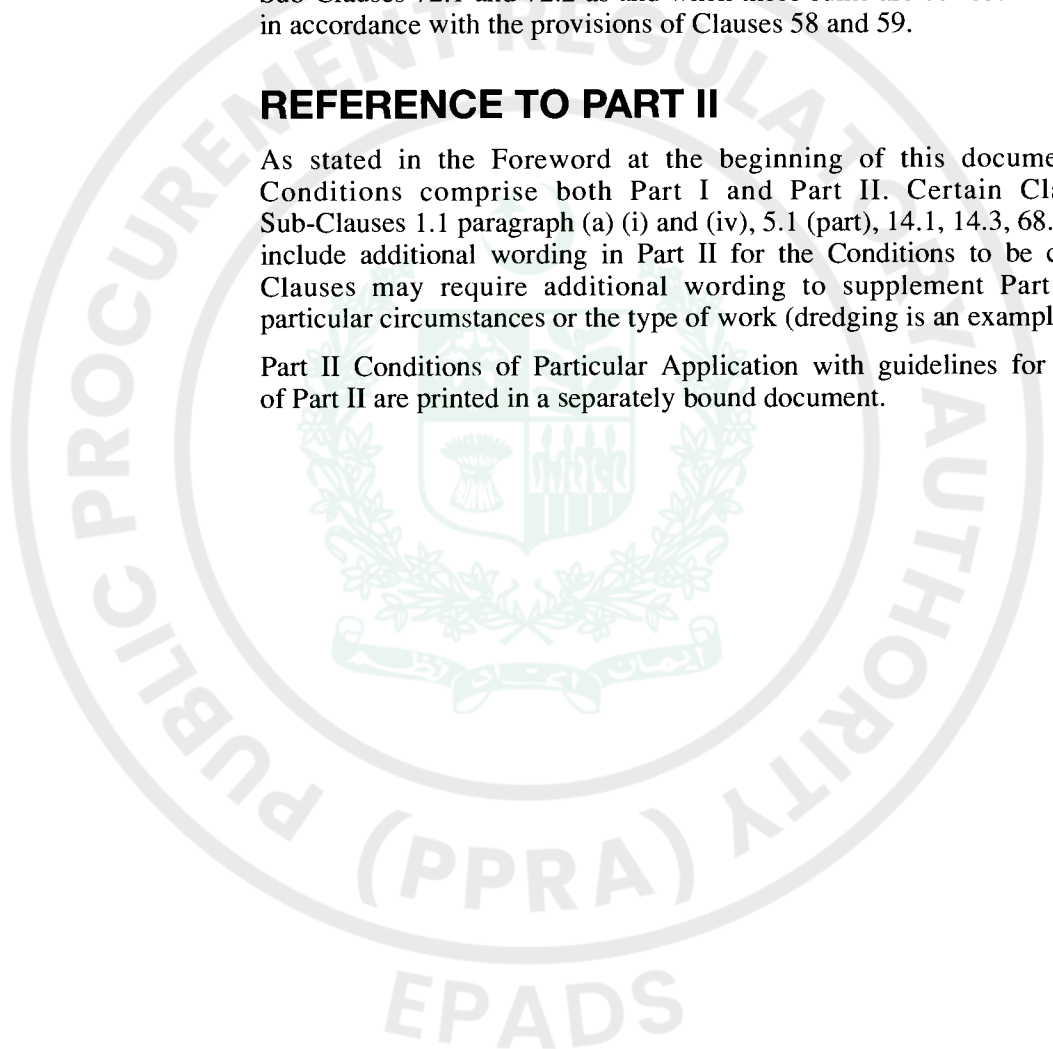

PART I – GENERAL CONDITIONS

Index

	Clause
Access to Site	42.1
Access to Works, Engineer	37.1
Access, Contractor to Satisfy Himself	11.1
Accident or Injury to Workmen – Insurance Against	24.2
Accident or Injury to Workmen – Liability for	24.1
Address, Change of	68.3
Adequacy of Insurance	25.2
Adjustment of Contract Price if Variations Exceed 15 per cent of Tender Sum	52.3
Agreement	9.1
Alterations, Additions and Omissions	51. & 52.
Ambiguities in Contract Documents	5.2
Amicable Settlement of Disputes	67.2
Appointment of Assistants to Engineer	2.4
Approval by the Engineer	7.3
Approval of Materials not Implied	54.8
Approval Only by Defects Liability Certificate	61.1
Arbitration	67.3
Assignment of Contract	3.1
Avoidance of Damage to Roads	30.1
Bills of Quantities – Estimated Only	55.1
Boreholes and Exploratory Excavation	18.1
Breakdown of Lump Sum Items	57.2
Care of Works	20.1
Cash Flow Estimate to be Submitted	14.3
Certificate, Final Payment	60.8
Certificates and Payment, Monthly Statements	60.1
Certificates, Correction of	60.4
Certificate, Taking-Over	48.1
Certification of Completion of Works	48.1
Certification of Completion of Sections or Parts	48.2
Cessation of Employer's Liability	60.9
Change of Address, Notice of	68.3
Claims, Contemporary Records	53.2
Claims, Notice of	53.1
Claims, Payment of	53.5
Claims, Substantiation of	53.3
Claims Under Performance Security	10.3
Clearance of Site on Completion	33.1
Commencement of Works	41.1
Completion of Works, Time for	43.1
Completion of Works, Time for, Extension of	44.1
Completion, Statement at	60.5
Compliance with Insurance Policy Conditions	25.4
Compliance with Statutes and Regulations	26.1
Contemporary Records for Claims	53.2
Contract Agreement	9.1
Contractor Not Relieved of Duties or Responsibilities	14.4
Contractor's Employees	16.1
Contractor's Employees, Engineer at Liberty to Object	16.2
Contractor's Entitlement to Suspend Work for Employer's Default	69.4
Contractor's Equipment, Conditions of Hire	54.5
Contractor's Equipment, Employer not Liable for Damage	54.2

Index

Clause

Contractor's Equipment, Insurance of	21.1
Contractor's Equipment, Reference in Subcontracts	54.7
Contractor's Equipment, Temporary Works and Materials; Exclusive Use for the Works	54.1
Contractor's Equipment, Transport of	30.2
Contractor's Failure to Carry Out Instructions	49.4
Contractor's Failure to Insure, Remedy	25.3
Contractor's General Responsibilities	8.1
Contractor's Superintendence	15.1
Contractor to Keep Site Clear	32.1
Contractor to Search	50.1
Correction of Certificates	60.4
Cost of Remedying Defects	49.3
Cost of Samples	36.2
Cost of Tests	36.3
Cost of Tests not Provided for	36.4
Covering up Work, Examination Before	38.1
Cross Liabilities	23.3
Currencies of Payment for Provisional Sums	72.3
Currencies, Rates of Exchange	72.1
Currency Restrictions	71.1
Custody and Supply of Drawings and Documents	6.1
Customs Clearance	54.3
Damage to Persons and Property	22.1
Damage to Roads, Avoidance of	30.1
Damage to Works, Special Risks	65.3
Damages, Liquidated	47.1
Dates for Inspection and Testing	37.3
Daywork	52.4
Decrease or Increase of Costs	70.1
Default of Contractor in Compliance with Instructions on Improper Work	39.2
Default of Contractor, Remedies for	63.1
Default of Employer	69.1
Defective Materials and Work	39.1
Defects, Contractor to Search for, if Required	50.1
Defects, Cost of Remedying	49.3
Defects Liability Certificate	62.1
Defects Liability Period	49.1
Defects, Remedying of	49.2
Definitions	1.1
Delay, Liquidated Damages for	47.1
Delays and Cost of Delay of Drawings	6.4
Design by Nominated Subcontractors	59.3
Discharge	60.7
Discrepancies in Documents	5.2
Dismissal of Contractor's Employees	16.2
Disorderly Conduct, etc.	34.1
Disputes, Engineer's Decision	67.1
Disruption of Progress	6.3
Documents Mutually Explanatory	5.2
Drawings	6 & 7
Drawings and Documents – Custody and Supply of	6.1
Drawings and Instructions – Supplementary	7.1
Drawings, Copy to be Kept on Site	6.2
Drawings, Delays and Cost of Delay of Drawings	6.4
Drawings, Failure by Contractor to Submit	6.5
Employer not Liable for Damage to Contractor's Equipment etc.	54.2

Index

Clause

Employer's Liability, Cessation of	60.9
Employer's Responsibilities	19.2
Employer's Risks	20.4
Engagement of Staff and Labour	34.1
Engineer's Authority to Delegate	2.3
Engineer's Determination Where Tests not Provided for	36.5
Engineer's Duties and Authority	2.1
Engineer to Act Impartially	2.6
Environment – Protection of	19.1
Errors in Setting Out	17.1
Evidence and Terms of Insurance	25.1
Examination of Work before Covering Up	38.1
Exceptions	22.2
Exchange, Rates of	72.1
Exclusions	21.4
Extension of Time, due to Employer's Failure to give Possession of Site	42.2
Extension of Time for Completion	44.1
Extension of Time for Completion, Contractor's Claim	44.2
Extension of Time for Completion, Engineer's Determination	44.3
Extraordinary Traffic	30.
Facilities for Other Contractors	31.2
Facilities – Rights of Way and	42.3
Failure by Contractor to Submit Drawings	6.5
Failure to Comply with Claims Procedure	53.4
Failure to Comply with Engineer's Decision	67.4
Failure to Give Possession of Site	42.2
Faulty Work, Removal of	39.1
Fees and Notices	26.1
Fencing, Watching, Lighting, etc.	19.1
Final Payment Certificate	60.8
Final Statement	60.6
Foreign Currencies, Payment in	72.
Fossils	27.1
Foundations, Examination of	38.1
General Responsibilities of Contractor	8.1
Giving of Notices – Payment of Fees	26.1
Headings and Marginal Notes	1.2
Improper Work and Materials, Removal of	39.1
Increase or Decrease of Costs	70.1
Indemnity by Contract	22.1
	& 24.1
Indemnity by Employer	22.3
Independent Inspection	37.5
Injury to Persons – Damage to Property	22.1
Injury to Workmen	24.1
Inspection and Testing	37.2
Inspection and Testing, Dates for	37.3
Inspection of Foundations, etc.	38.1
Inspection of Operations	37.1
Inspection of Site by Contractor	11.1
Instructions for Variations	51.2
Instructions in Writing	2.5
Instructions, Supplementary	7.1
Insurance, Adequacy of	25.2

Index

Clause

Insurance, Evidence and Terms of	25.1
Insurance, Minimum Amount of	23.2
Insurance of Works and Contractor's Equipment	21.1
Insurance, Remedy on Failure to Insure	25.3
Insurance, Responsibility for Amounts not Recovered	21.3
Insurance, Scope of Cover	21.2
Insurance, Third Party	23.1
Insurance, Workmen	24.2
Interference with Traffic and Adjoining Properties	29.1
Interim Determination of Extension	44.3
Interpretations	1.3
Labour, Engagement of	34.1
Language/s and Law	5.1
Law to which Contract Subject	5.1
Legislation, Subsequent	70.2
Lighting, Fencing, Watching, etc.	19.1
Liquidated Damages for Delay	47.1
Liquidated Damages, Reduction of	47.2
Loss or Damage due to Employer's Risks	20.3
Loss or Damage – Responsibility to Rectify	20.2
Lump Sum Items – Breakdown of	57.2
Materials and Plant, Transport of	30.3
Materials – Approval of, etc, not Implied	54.8
Materials, Improper – Removal of	39.1
Materials, Quality of	36.1
Materials, Supply of	8.1
Measurement by Engineer	56.1
Measurement, Method of	57.1
Measurement, Quantities Estimated Only	55.1
Methods of Construction	8.2
Minimum Amount of Insurance	23.2
Monthly Payments	60.2
Nominated Subcontractors, Certification of Payments to	59.5
Nominated Subcontractors, Definition	59.1
Nominated Subcontractors, Design by	59.3
Nominated Subcontractors, Objection to Nomination	59.2
Nominated Subcontractors, Payment to	59.4
Not Foreseeable Physical Obstructions or Conditions	12.2
Notice of Claims	53.1
Notices and Fees, Payment of	26.1
Notices, Consents and Approvals	1.5
Notice to Contractor	68.1
Notice to Employer and Engineer	68.2
Objections to Contractor's Employees	16.2
Obstructions or Conditions – Not Foreseeable Physical	12.2
Omissions, Alterations and Additions	59.
Openings, Uncovering and making	38.2
Operations, Inspection of	37.1
Order of Work, Contractor to Furnish Programme	14.1
Other Contractors, Opportunities for	31.1
Patent Rights	28.1
Payment if Contract Terminated for Contractor's Default	63.3
Payment if Contract Terminated for Employer's Default	69.3
Payment of Claims	53.5

Index

Clause

Payment, Time for	60.10
Performance Security	10.1
Performance Security – Claims Under	10.3
Performance Security – Period of Validity	10.2
Period of Defects Liability	49.1
Permanent Works Designed by Contractor	7.2
Physical Obstructions or Conditions – Not Foreseeable	12.2
Physical Obstructions or Conditions – Engineer’s Determination	12.3
Plant and Materials, Transport of	30.3
Plant, Conditions of Hire	54.5
Plant, Customs Clearance	54.3
Plant, Employer not Liable for damage to	54.2
Plant, etc. – Exclusive Use for the Works	54.1
Plant, Quality of	36.1
Plant, Re-export of	54.4
Plant, Removal of	39.1
Policy of Insurance – Compliance with Conditions	25.4
Possession of Site	42.1
Possession of Site, Failure to Give	42.2
Power of Engineer to Fix Rates	52.2
Priority of Contract Documents	5.2
Programme to be Submitted	14.1
Progress – Disruption of	6.3
Progress – Rate of	46.1
Protection of Environment	19.1
Provision to Indemnify Contractor	22.3
Provision to Indemnify Employer	22.2
Provisional Sums, Currencies of Payment	72.3
Provisional Sums, Definition	58.1
Provisional Sums, Production of Vouchers	58.3
Provisional Sums, Use of	58.2
Quality of Materials and Workmanship	36.1
Quantities	55.1
Rate of Progress	46.1
Rates of Exchange	72.1
Rates, Power of Engineer to Fix	52.2
Rectification of Loss or Damage	20.2
Reduction of Liquidated Damages	47.2
Re-export of Plant	54.4
Regulations, Statutes, etc., Compliance with	26.1
Rejection	37.4
Release from Performance	66.1
Remedies for Default of Contractor	63.1
Remedying of Defects	49.2
Remedying of Defects, Cost of	49.3
Remedy on Contractor’s Failure to Insure	25.3
Removal of Contractor’s Employees	16.2
Removal of Contractor’s Equipment	69.2
Removal of Improper Work, Materials or Plant	39.1
Removal of Plant, etc.	65.7
Responsibility to Rectify Loss or Damage	20.2
Responsibility Unaffected by Approval	7.3
Restriction on Working Hours	45.1
Resumption of Work	69.5
Retention Money, Payment of	60.3
Returns of Labour and Contractor’s Equipment	35.1

Index

Clause

Revised Programme	14.2
Rights of Way and Facilities	42.3
Risks, Employer's	20.4
Risks, Special	65.
Roads, etc., - Damage by Extraordinary Traffic	30.1
Roads, Interference with Access to	29.1
Royalties	28.2
Safety, Security and Protection of the Environment	19.1
Samples, Cost of	36.2
Security, Safety and Protection of the Environment	19.1
Setting-Out	17.1
Singular and Plural	1.4
Site, Clearance on Completion	33.1
Site, Contractor to Keep Clear	32.1
Site, Inspection of by Contractor	11.1
Site Operations and Methods of Construction	8.2
Site, Possession of	42.1
Special Risks	65.
Staff, Engagement of	34.1
Statement at Completion	60.5
Statement, Final	60.6
Statutes, Regulations, etc. - Compliance with	26.1
Subcontracting	4.1
Subcontractors, Nominated	59.
Subcontractors, Responsibility of the Contractor for Acts and Default of	4.1
Subsequent Legislation	70.2
Substantial Completion of Sections or Parts	48.3
Sufficiency of Tender	12.1
Supply of Plant, Materials and Labour	8.1
Surfaces Requiring Reinstatement	48.4
Suspension, Engineer's Determination	40.2
Suspension lasting more than 84 days	40.3
Suspension of Work	40.1
Taking Over Certificate	48.1
Taking Over of Sections or Parts	48.2
Tender Documents	11.1
Tender, Sufficiency of	12.1
Termination of Contract by Employer	63.1
Termination of Contract by Employer, Assignment of Benefit	63.4
Terms of Insurance	25.1
Tests, Cost of	36.3
Tests not Provided for - Cost of	36.4
Third Party Insurance	23.1
Time for Completion	43.1
Time for Completion, Extension of	44.1
Time for Payment	60.10
Traffic, Extraordinary	30.1
Traffic, Interference with	29.1
Traffic, Waterborne	30.4
Transport of Contractor's Equipment and Temporary Works	30.2
Transport of Materials and Plant	30.3
Uncovering Work and Making Openings	38.2
Unfulfilled Obligations	62.2
Urgent Remedial Work	64.1

Index

Clause

Valuation at Date of Termination by the Employer	63.2
Variations	51.1
Variations, Daywork Basis	52.4
Variations, Exceeding 15 per cent	52.3
Variations, Instructions for	51.2
Variations, Power of the Engineer to Fix Rates	52.2
Variations, Valuation of	51.3
Vouchers, Production of	58.3
War, Outbreak of	20.4
Watching and Lighting, etc.	19.1
Waterborne Traffic	30.4
Work, Examination of Before Covering Up	38.1
Work, Improper, Removal of	39.1
Working Hours, Restriction of	45.1
Workmanship, Quality of	36.1
Workmen, Accident or Injury to	24.1
Works, Care of	20.1
Works, Completion of (Defects Liability Certificate)	62.1
Works, Commencement of	41.1
Works, Insurance of	21.1
Works, Remedying of Defects	49.2
Works, Time for Completion of	43.1
Works to be Measured	56.1
Work, Suspension of	40.1
Work to be in Accordance with the Contract	13.1

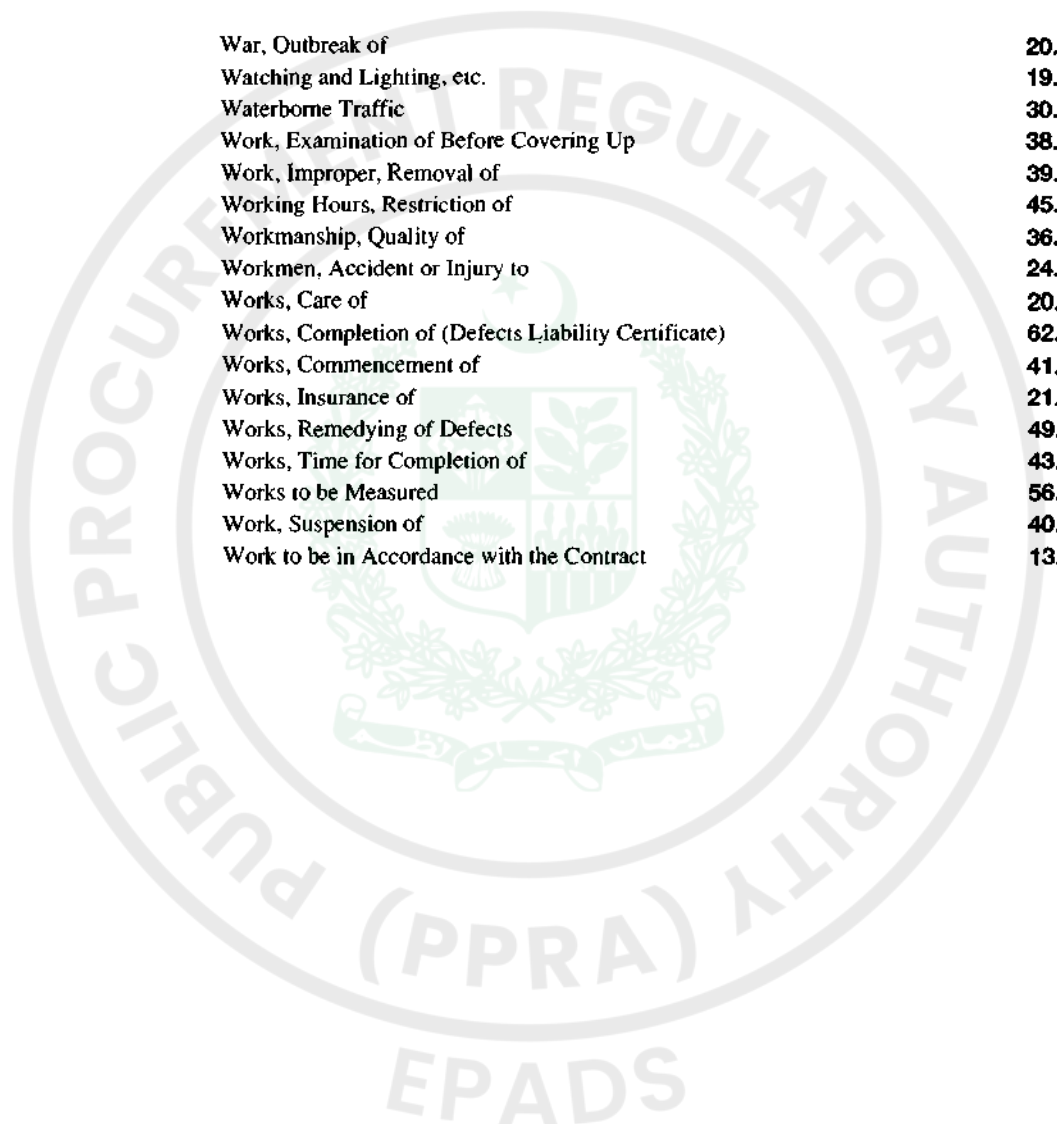

Page blank
in original



TENDER

NAME OF CONTRACT: * _____

TO:* _____

Gentlemen,

1. Having examined the Conditions of Contract, Specification, Drawings, and Bill of Quantities and Addenda Nos _____ for the execution of the above-named Works, we, the undersigned, offer to execute and complete such Works and remedy any defects therein in conformity with the Conditions of Contract, Specification, Drawings, Bill of Quantities and Addenda for the sum of _____

(_____)
or such other sum as may be ascertained in accordance with the said Conditions.

2. We acknowledge that the Appendix forms part of our Tender.
3. We undertake, if our Tender is accepted, to commence the Works as soon as is reasonably possible after the receipt of the Engineer's notice to commence, and to complete the whole of the Works comprised in the Contract within the time stated in the Appendix to Tender.
4. We agree to abide by this Tender for the period of * _____ days from the date fixed for receiving the same and it shall remain binding upon us and may be accepted at any time before the expiration of that period.
5. Unless and until a formal Agreement is prepared and executed this Tender, together with your written acceptance thereof, shall constitute a binding contract between us.
6. We understand that you are not bound to accept the lowest or any tender you may receive.

Dated this _____ day of _____ 19 _____

Signature _____ in the capacity of _____

duly authorised to sign tenders for and on behalf of _____

(IN BLOCK CAPITALS)

Address _____

Witness _____

Address _____

Occupation _____

(Note: All details marked * shall be inserted before issue of Tender documents.)

Appendix

	Sub-Clause	
Amount of security (if any) _____	10.1	_____ per cent of the Contract Price
Minimum amount of third party insurance	23.2	_____ per occurrence, with the number of occurrences unlimited
Time for issue of notice to commence	41.1	_____ days
Time for Completion _____	43.1	_____ days
Amount of liquidated damages _____	47.1	_____ per day
Limit of liquidated damages _____	47.1	_____
Defects Liability Period _____	49.1	_____ days
Percentage for adjustment of Provisional Sums	59.4(c)	_____ percent
Percentage of invoice value of listed materials and Plant _____	60.1 (c)	_____ per cent
Percentage of Retention _____	60.2	_____ per cent
Limit of Retention Money _____	60.2	_____
Minimum Amount of Interim Payment Certificates _____	60.2	_____
Rate of interest upon unpaid sums _____	60.10	_____ per cent per annum
Initials of Signatory of Tender _____		

(Notes: All details in the list above, other than percentage figure against Sub-Clause 59.4, shall be inserted before issue of Tender documents. Where a number of days is to be inserted, it is desirable, for consistency with the Conditions, that the number should be a multiple of seven.

Additional entries are necessary where provision is included in the Contract for:

- (a) completion of Sections (Sub-Clauses 43.1 and 48.2(a))
- (b) liquidated damages for Sections (Sub-Clause 47.1)
- (c) a bonus (Sub-Clause 47.3 – Part II)
- (d) payment for materials on Site (Sub-Clause 60.1(c))
- (e) payment in foreign currencies (Clause 60 – Part II)
- (f) an advance payment (Clause 60 – Part II)
- (g) adjustments to the Contract Price on account of Specified Materials
(Sub-Clause 70.1 – Part II)
- (h) rates of exchange (Sub-Clause 72.2 – Part II)

Agreement

This Agreement made the _____ day of _____ 19 _____

Between _____

of _____

_____ (hereinafter called "the Employer") of the one part and

_____ of _____

(hereinafter called "the Contractor") of the other part

Whereas the Employer is desirous that certain Works should be executed by the Contractor, viz _____

and has accepted a Tender by the Contractor for the execution and completion of such Works and the remedying of any defects therein

Now this Agreement witnesseth as follows:

1. In this Agreement words and expressions shall have the same meanings as are respectively assigned to them in the Conditions of Contract hereinafter referred to.
2. The following documents shall be deemed to form and be read and construed as part of this Agreement, viz:
 - (a) The Letter of Acceptance;
 - (b) The said Tender;
 - (c) The Conditions of Contract (Parts I and II);
 - (d) The Specification;
 - (e) The Drawings; and
 - (f) The Bill of Quantities.
3. In consideration of the payments to be made by the Employer to the Contractor as hereinafter mentioned the Contractor hereby covenants with the Employer to execute and complete the Works and remedy any defects therein in conformity in all respects with the provisions of the Contract.
4. The Employer hereby covenants to pay the Contractor in consideration of the execution and completion of the works and the remedying of defects therein the Contract Price or such other sum as may become payable under the provisions of the Contract at the times and in the manner prescribed by the Contract.

In Witness whereof the parties hereto have caused this Agreement to be executed the day and year first before written in accordance with their respective laws.

The Common Seal of _____

_____ was hereunto affixed in the presence of:-

or

Signed Sealed and Delivered by the

said _____

in the presence of:

EDITORIAL AMENDMENTS IN 1988

Following publication of the Fourth Edition in 1987 of the Conditions of Contract for Works of Civil Engineering Construction, a number of editorial amendments were agreed by FIDIC. The amendments were incorporated during a 1988 reprinting and the list below clarifies the differences between the 1988 reprint and the original document.

Foreword		The last sentence of the first paragraph previously read “The Conditions are equally suitable for use on domestic contracts. ”
Page	6	Sub-Clause 10.1. A comma has been inserted after the word “Contract” in the second line. The third sentence previously read “Such security shall be in such form as may be agreed between the Employer and the Contractor.”
Page	11	Sub-Clause 22.1 (b) was previously one complete paragraph, ie there was no space between the words “. . . other than the Works), ” and the remainder of the Sub-Clause.
Page	15	Sub-Clause 31.2 (c) was previously one complete paragraph, ie there was no space between the words “. . . nature for any such,” and the remainder of the Sub-Clause.
Page	20	Sub-Clause 44.3. The penultimate sentence was previously, “In both such cases the Engineer shall notify the Contractor accordingly, with a copy to the Employer. ”
Page	21	Sub-Clause 49.1 (a). The word “substantial” has been deleted.
Page	29	Sub-Clause 60.3 (b) was previously two paragraphs, the second beginning with the words “Provided also that if at such time . . . ”
Page	30	Sub-Clause 60.5. The word “The” has been inserted at the beginning of the final paragraph.
Page	35	Sub-Clause 67.1. In the eighth line of the third paragraph, a comma has been inserted after the word “provided”. In the second line of the fourth paragraph, the word “notice” replaces the word “notification”.
Page	38	Reference to Part II. In the third line, the words “and (iv)” have been inserted after paragraph (a) (i).
Tender		
Item	3.	The word “Works” has been capitalised.
Agreement		
Line	4	Inverted commas have been inserted following the words “the Employer.”
Line	6	Inverted commas have been inserted before the word “the” instead of before the word “Contractor.”
Line	8	The word “Contractor” has been capitalised.
Line	9	The words “Tender by the Contractor” were previously “Tender by Contractor. ”
Line	11	The word “Agreement” has been capitalised.
Last lines		The Agreement previously ended with the words “Binding Signature of Employer” and “Binding Signature of Contractor”.

FURTHER AMENDMENTS IN 1992

The following amendments have been made to the 1988 Reprint of the Fourth Edition of the Conditions of Contract for Works of Civil Engineering Construction. The amendments of the 1988 Reprint are shown on the previous page. In addition, some minor changes in the use of punctuation marks (commas, semicolons, colons and stops), as well as the use of the words “or” and “and” have been introduced to attain uniformity in the style of all Clauses. These minor changes which improve the style, but which have no effect on the meaning of Clauses, have not been listed below.

FOREWORD

The eighth paragraph previously referred to the anticipated publication of the “Guide to the Use of FIDIC Conditions of Contract for Works of Civil Engineering Construction”.

- Page 2** Sub-Clause 1.1, sub-para (e). Definitions (iii) “Interim Payment Certificate” and (iv) “Final Payment Certificate” have been added.
- Page 6** Sub-Clause 8.1. Second paragraph has been added.
- Page 7** Sub-Clause 12.2. Marginal note. The word “Adverse” has been changed to read “Not Foreseeable” (also amended in the Contents and the Index).
- Page 8** Sub-Clause 13.1. Last sentence has been shortened by deleting the words “or, subject to the provisions of Clause 2, from the Engineer’s Representative.”, and adding the words “(or his delegate).”.
- Sub-Clause 15.1, para 1. Last sentence has been shortened by placing a full stop after the word “Engineer”, deleting the words “or subject to the provisions of Clause 2, the Engineer’s Representative.”
- Page 10** Sub-Clause 21.1, sub-para (a). The words “(the term “cost” in this context shall include profit)” have been added.
- Page 11** Sub-Clause 21.4, sub-para (a). The word “where” has been corrected to read “whether”.
- Page 18** Sub-Clause 40.3. The word “written” has been deleted at the end of the first line.
- Page 19** Sub-Clause 42.3. The word “wayleaves” has been changed to read “rights of way” in the text and marginal note (also amended in the Contents and the Index).
- Page 29** Sub-Clause 60.1, sub-para (e). The words “or otherwise” have been added at the end
- Sub-Clause 60.2. The words “certify to the Employer” have been changed to read “deliver to the Employer an Interim Payment Certificate stating”, the word “thereof” has been changed to read “of such statement” and the word “he” has been changed to read “the Engineer”. Sub-para (b). The words “Interim Certificates” have been changed to read “Interim Payment Certificates”.
- Sub-Clause 60.3, sub-para (b). In the eighth line, the word “ordered” has been changed to read “instructed”.
- Sub-Clause 60.4. The words “interim certificate” in the first and fourth lines, and the word “certificate” in the second line, have been changed to read “Interim Payment Certificate”.
- Page 30** Sub-Clause 60.5. In the second line, after the word “Engineer”, the words “six copies of” have been added.
- Sub-Clause 60.6. In the second line, after the word “consideration”, the words “six copies of” have been added. Sub-para (b). The words “or otherwise” have been added at the end. At the end of the sub-clause, the final paragraph has been added.
- Sub-Clause 60.7 and Sub-Clause 60.8 (text and marginal note). The words “Final Certificate” have been changed to read “Final Payment Certificate” (also amended in the Contents and the Index).
- Sub-Clause 60.8 (a). The words “or otherwise” have been added. Sub-Clause 60.8 (b). The words “under the Contract other than Clause 47” have been changed to read “other than under Clause 47”.
- Sub-Clause 60.10. In the first and fourth lines, the words “interim certificate” have

Page	31	been changed to read “Interim Payment Certificate”. In the fifth and sixth lines, the words “Final Certificate” have been changed to read “Final Payment Certificate”. The words “or otherwise” have been added at the end.
Page	33	Sub-Clause 65.6. In the ninth line, the words “and to the operation of Clause 67” have been changed to read “and Clause 67”.
Page	34	Sub-Clause 66.1. In the second line the word “party” has been changed to read “or both parties”, in the third line between the words “his” and “contractual” the words “or their” have been added. In the fourth line after the word “then”, the words “the parties shall be discharged from the Contract, except as to their rights under this Clause and Clause 67 and without prejudice to the rights of either party in respect of any antecedent breach of the Contract, and ” have been added.
Page	35	Sub-Clause 67.2. The words “arbitration of such dispute shall not be commenced unless an attempt has first been made by the parties to settle such dispute amicably” have been changed to read “ the parties shall attempt to settle such dispute amicably before the commencement of arbitration.” The words “whether or not any attempt at amicable settlement thereof has been made” have been changed to read “even if no attempt at amicable settlement thereof has been made”.
Page	37	Sub-Clause 69.1, Sub-para (d). The words “unforeseen reasons, due to economic dislocation” have been changed to read “unforeseen economic reasons”. Sub-Clause 69.4. In the second line of the second paragraph, the word “cost” has been changed to read “costs”.
Page	38	REFERENCE TO PART II. In the third line, the words “5.1 part” have been changed to read “5.1 (part)”.
TENDER Appendix		Paragraph 1. In the last line, the word “sums” has been changed to read “sum”. In the ninth line, the words “and Plant” have been added. In the twelfth line, the word “Payment” has been added. In the thirteenth line, the words “per annum” have been added.
EDITORIAL AMENDMENTS		For page 35, after the words “Sub-Clause 67.1” the first sentence has been inserted.



Published by
Fédération Internationale des
Ingénieurs-Conseils (FIDIC)
PO Box 86
CH 1000 Lausanne 12
Switzerland
Tel. +41 21 653 50 03
Fax +41 21 653 54 32

Copyright FIDIC 1987

**Reprinted 1988
with editorial amendments**

**Reprinted 1992 with
further [REDACTED] amendments**

All rights reserved.
No part of this publication may be
reproduced or transmitted in any
form or by any means without
permission of publisher.



FEDERATION INTERNATIONALE DES INGENIEURS-CONSEILS

CONDITIONS OF CONTRACT

FOR WORKS OF CIVIL

ENGINEERING CONSTRUCTION

**PART II CONDITIONS OF PARTICULAR
APPLICATION WITH GUIDELINES FOR
PREPARATION OF PART II CLAUSES**

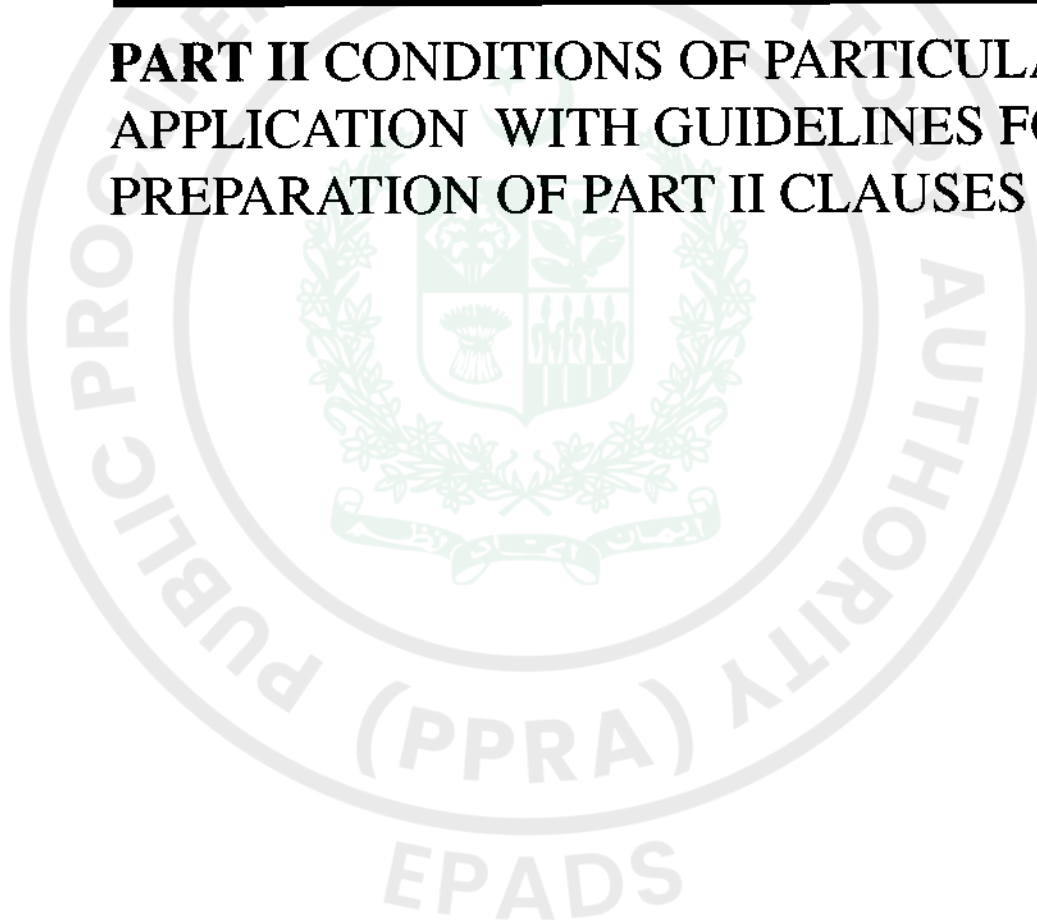

FOURTH EDITION 1987

Reprinted 1988 with editorial amendments

Reprinted 1992 with further amendments

CONTENTS

PART II: CONDITIONS OF PARTICULAR APPLICATION

	Page
Introduction (including special reference to Dredging and Reclamation Work)	1
1 Definitions	3
2 Engineer's Duties	3
5 Language/s and Law and Documents	3
9 Contract Agreement	4
10 Performance Security	4
11 Inspection of Site	5
12 Not Foreseeable Physical Obstructions or Conditions	5
14 Programme and Cash Flow Estimate	5
15 Contractor's Superintendence	9
16 Contractor's Employees	9
18 Boreholes and Exploratory Excavation	9
19 Safety, Security and Protection of the Environment	9
21 Insurance of Works and Contractor's Equipment	10
21, 23 & 25 Insurances Arranged by Employer	10
28 Royalties	11
31 Opportunities for Other Contractors	12
34 Labour	12
35 Records and Reports	14
40 Suspension	14
43 Time for Completion	14
45 Restriction on Working Hours	14
47 Bonuses	15
48 Prevention from Testing	15
49 Defects Liability	16
50 Contractor to Search	16
51 Variations	16
52 Payment in Foreign Currency	17
54 Vesting of Contractor's Equipment	17
60 Certificates and Payments	18
67 Settlement of Disputes	19
68 Notices	20
69 Default of Employer	20
70 Changes in Cost and Legislation	20
72 Currency Proportions	24
73 Additional Clauses	25
INDEX	
EDITORIAL AMENDMENTS IN 1988	
FURTHER AMENDMENTS IN 1992	

INTRODUCTION

The terms of the Fourth Edition of the Conditions of Contract for Works of Civil Engineering Construction have been prepared by the Fédération Internationale des Ingénieurs Conseils (FIDIC) and are recommended for general use for the purpose of construction of such works where tenders are invited on an international basis. The Conditions, subject to minor modifications, are also suitable for use on domestic contracts.

The version in English of the Conditions is considered by FIDIC as the official and authentic text for the purpose of translation.

The Clauses of general application have been grouped together in a separately bound document and are referred to as Part I—General Conditions. They have been printed in a form which will facilitate their inclusion, as printed, in the contract documents normally prepared.

In the preparation of the Conditions it was recognised that while there are numerous Clauses which will be generally applicable there are some Clauses which must necessarily vary to take account of the circumstances and locality of the Works.

Part I – General Conditions and Part II – Conditions of Particular Application together comprise the Conditions governing the rights and obligations of the parties.

For this reason a Part II standard form has not been produced. It will be necessary to prepare a Part II document for each individual contract and the Guidelines are intended to aid in this task by giving options for various clauses where appropriate.

Part II clauses may arise for one or more reasons, of which the following are examples:

(i) Where the wording in Part I specifically requires that further information is to be included in Part II and the Conditions would not be complete without that information, namely in Sub-Clauses 1.1 paragraphs (a) (i) and (iv), 5.1 (part), 14.1, 14.3, 68.2 and 70.1

(ii) Where the wording in Part I indicates that supplementary information may be included in Part II, but the conditions would still be complete without any such information, namely in Sub-Clauses 2.1 paragraph (b), 5.1 (part), 21.1 paragraph (b) and 72.2.

(iii) Where the type, circumstances or locality of the Works necessitates additional Clauses or Sub-Clauses.

(iv) Where the law of the country or exceptional circumstances necessitate an alteration in Part I. Such alterations should be effected by stating in Part II that a particular Clause, or part of a Clause, in Part I is deleted and giving the substitute Clause, or part, as applicable.

As far as possible, in the Clauses that are mentioned hereunder, example wording is provided. In the case of some Clauses, however, only an aide-memoire for the preparation is given. Before incorporating any example wording it must be checked to ensure that it is wholly suitable for the particular circumstances and, if not, it must be varied. Where example wording is varied and in all cases where additional material is included in Part II, care must be taken that no ambiguity is created with Part I or between the Clauses in Part II.

Dredging and Reclamation Work

Special consideration must be given to Part II where dredging and certain types of reclamation work are involved. Dredgers are considerably more expensive than most items of Contractor's Equipment and the capital value of a dredger can often exceed the value of the Contract on which it is used.

For this reason, it is in the interests of both the Employer and the Contractor that a dredger is operated intensively in the most economic fashion, subject to the quality of work and any other over-riding factors. With this end in view, it is customary to allow the Contractor to execute dredging work continuously by day and by night seven days a week. Another difference from most civil engineering is that on dredging work the Contractor is not normally held responsible for the remedying of defects after the date of completion as certified under Clause 48. Part II contains explanations and example wording to cover the above points and others relating to dredging. Clauses 11, 12, 18, 19, 28, 40, 45, 49, 50 and 51 are those which most often require attention in Part II when dredging work is involved and reference is included under each of these Clauses. Other Clauses may also need additions in Part II in certain circumstances. Reclamation work varies greatly in character and each instance must be considered before deciding whether it is appropriate to introduce in Part II changes similar to those adopted for dredging, or to use the standard civil engineering form unaltered.

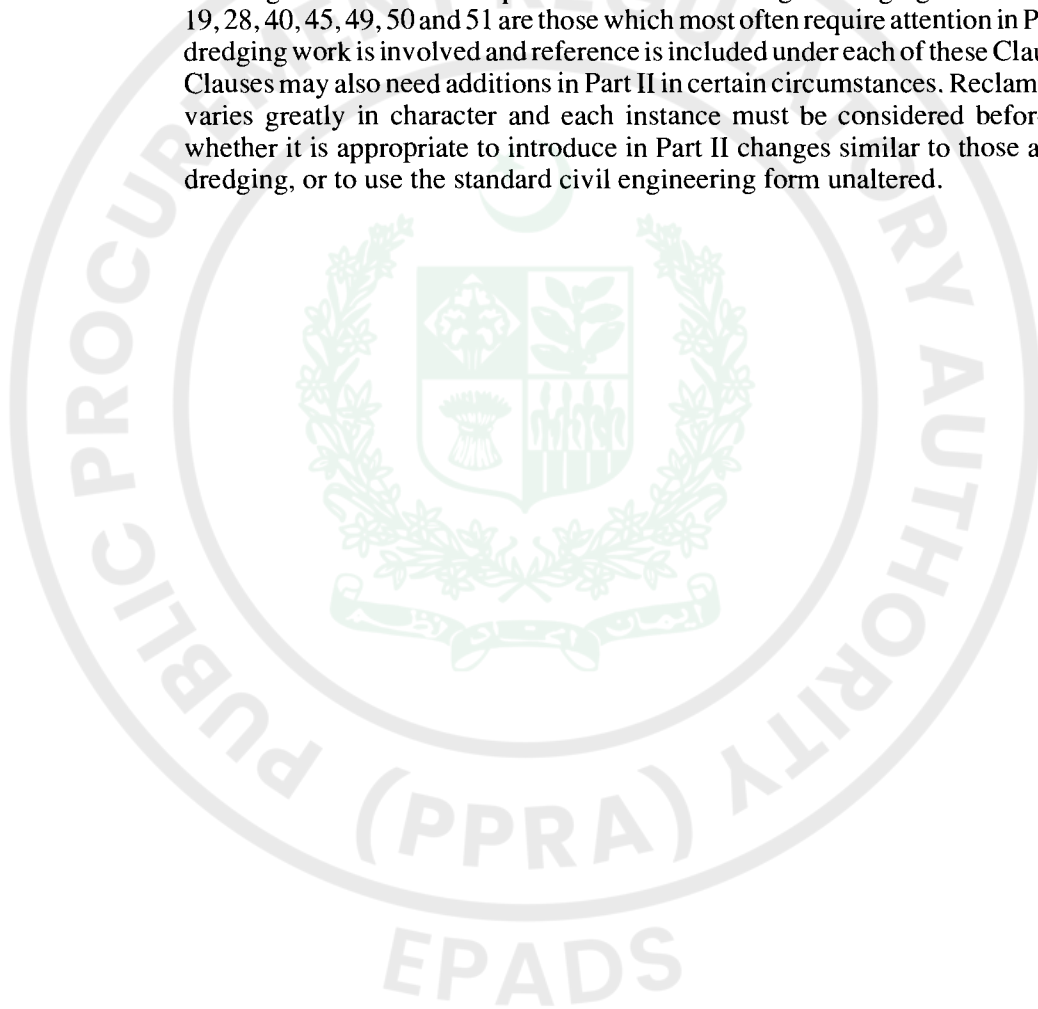

PART II CONDITIONS OF PARTICULAR APPLICATION

Clause 1

Sub-Clause 1.1 – Definitions

(a) (i) The Employer is (insert name)

(a) (iv) The Engineer is (insert name)

If further definitions are essential, additions should be made to the list.

Clause 2

Sub-Clause 2.1 – Engineer’s Duties

EXAMPLE

The Engineer shall obtain the specific approval of the Employer before carrying out his duties in accordance with the following Clauses of Part 1:

(a) Clause (insert applicable number)

(b) Clause (insert applicable number)

(c) Clause (insert applicable number)

This list should be extended or reduced as necessary.

In some cases the obligation to obtain the approval of the Employer may apply to only one Sub-Clause out of several in a Clause or approval may only be necessary beyond certain limits, monetary or otherwise. Where this is so, the example wording must be varied.

If the obligation to obtain the approval of the Employer could lead to the Engineer being unable to take action in an emergency, where matters of safety are involved, an additional paragraph may be necessary.

EXAMPLE

Notwithstanding the obligation, as set out above, to obtain approval, if, in the opinion of the Engineer, an emergency occurs affecting the safety of life or of the Works or of adjoining property, he may, without relieving the Contractor of any of his duties and responsibilities under the Contract, instruct the Contractor to execute all such work or to do all such things as may, in the opinion of the Engineer, be necessary to abate or reduce the risk. The Contractor shall forthwith comply, despite the absence of approval of the Employer, with any such instruction of the Engineer. The Engineer shall determine an addition to the Contract Price, in respect of such instruction, in accordance with Clause 52 and shall notify the Contractor accordingly, with a copy to the Employer.

Clause 5

Sub-Clause 5.1 – Language/s and Law

(a) The language is (insert as applicable)

(b) The law is that in force in (insert name of country)

If necessary (a) above should be varied to read:

The languages are (insert as applicable)

and there should be added

The Ruling Language is (insert as applicable)

Sub-Clause 5.2 – Priority of Contract Documents

Where it is decided that an order of precedence of all documents should be included, this Sub-Clause may be varied as follows:

EXAMPLE

Delete the documents listed 1 - 6 and substitute:

(1) the Contract Agreement (if completed);

(2) the Letter of Acceptance;

(3) the Tender;

(4) the Conditions of Contract Part II;

(5) the Conditions of Contract Part I;

(6) the Specification;

(7) the Drawings; and

(8) the priced Bill of Quantities

or

Where it is decided that no order of precedence of documents should be included, this Sub-Clause may be varied as follows:

EXAMPLE

Delete the text of the Sub-Clause and substitute:

The several documents forming the Contract are to be taken as mutually explanatory of one another, but in the case of ambiguities or discrepancies the priority shall be that accorded by law. If, in the opinion of the Engineer, such ambiguities or discrepancies make it necessary to issue any instruction to the Contractor in explanation or adjustment, the Engineer shall have authority to issue such instruction.

Clause 9

Where it is decided that a Contract Agreement should be entered into and executed the form must be annexed to these Conditions as stated in Sub-Clause 9.1 of Part I of these Conditions.

A suitable form is annexed to Part I – General Conditions.

Clause 10

Sub-Clause 10.1 – Performance Security

Where it is decided that a performance security should be obtained by the Contractor, the form must be annexed to these Conditions as stated in Sub-Clause 10.1 of Part I of these Conditions.

Two example forms of performance security are given on pages 7, 8 and 9. The Clause and wording of the example forms may have to be varied to comply with the law of the Contract which may require the forms to be executed under seal.

Where there is provision in the Contract for payments to the Contractor to be made in foreign currency, Sub-Clause 10.1 of Part I of these Conditions may be varied.

EXAMPLE

After the first sentence, insert the following sentence:

The security shall be denominated in the types and proportions of currencies stated in the Appendix to Tender.

Where the source of the performance security is to be restricted, an additional Sub-Clause may be added.

Source of Performance Security 10.4 **EXAMPLE SUB-CLAUSES**
The performance security, submitted by the Contractor in accordance with Sub-Clause 10.1, shall be furnished by an institution registered in (insert the country where the Works are to be executed) or licensed to do business in such country.

or

Source of Performance Security 10.4 *Where the performance security is in the form of a bank guarantee, it shall be issued by:*
(a) a bank located in the country of the Employer, or
(b) a foreign bank through a correspondent bank located in the country of the Employer.

Clause 11

Where the bulk or complexity of the data, or reasons of security enforced by the country where the Works are to be executed, makes it impracticable for the Employer to make all data available with the Tender Documents and inspection of some data by the Contractor at an office is therefore expected, it would be advisable to make the circumstances clear.

Access to Data 11.2 **EXAMPLE SUB-CLAUSE**
Data made available by the Employer in accordance with Sub-Clause 11.1 shall be deemed to include data listed elsewhere in the Contract as open for inspection at (insert particulars of the office or offices where such data is stored)

Sub-Clause 11.1 – Inspection of Site

For a Contract comprising dredging and reclamation work the Clause may be varied as follows:

EXAMPLE

In the first paragraph, delete the words “hydrological and sub-surface” and substitute “hydrographic and sub-seabed”.

In the second paragraph, under (a) delete the word “sub-surface” and substitute “sub-seabed” and under (b) delete the word “hydrological” and substitute “hydrographic”.

Clause 12

Sub-Clause 12.2 – Not Foreseeable Obstructions or Conditions

For a Contract comprising dredging and some types of reclamation work the Sub-Clause may require to be varied.

EXAMPLE

Delete the words “, other than climatic conditions on the Site,”.

Clause 14

Sub-Clause 14.1 – Programme to be Submitted

The time within which the programme shall be submitted shall be (insert number) days.

Sub-Clause 14.3 – Cash Flow Estimate to be Submitted

The time within which the detailed cash flow estimate shall be submitted shall be (insert number) days.

In both examples given above it is desirable for consistency with the rest of the Conditions that the number of days inserted should be a multiple of seven.

EXAMPLE PERFORMANCE GUARANTEE

By this guarantee We, _____
whose registered office is at _____
(hereinafter called "the Contractor") and _____
whose registered office is at _____
(hereinafter called "the Guarantor") are held and firmly bound unto
_____ (hereinafter called "the Employer")
in the sum of _____ for the payment of which sum
the Contractor and the Guarantor bind themselves, their successors and assigns
jointly and severally by these presents.

Whereas the Contractor by an Agreement made between the Employer of the one
part and the Contractor of the other part has entered into a Contract (hereinafter
called "the said Contract ") to execute and complete certain Works and remedy
any defects therein as therein mentioned in conformity with the provisions of the
said Contract.

Now the Condition of the above-written Guarantee is such that if the Contractor
shall duly perform and observe all the terms provisions conditions and
stipulations of the said Contract on the Contractor's part to be performed and
observed according to the true purport intent and meaning thereof or if on
default by the Contractor the Guarantor shall satisfy and discharge the damages
sustained by the Employer thereby up to the amount of the above-written
Guarantee then this obligation shall be null and void but otherwise shall be and
remain in full force and effect but no alteration in terms of the said Contract or in
the extent or nature of the Works to be executed, completed and defects therein
remedied thereunder and no allowance of time by the Employer or the Engineer
under the said Contract nor any forbearance or forgiveness in or in respect of any
matter or thing concerning the said Contract on the part of the Employer or the
said Engineer shall in any way release the Guarantor from any liability under the
above-written Guarantee. Provided always that the above obligation of
Guarantor to satisfy and discharge the damages sustained by the Employer shall
arise only

(a) on written notice from both the Employer and the Contractor that the
Employer and the Contractor have mutually agreed that the amount of damages
concerned is payable to the Employer or

(b) on receipt by the Guarantor of a legally certified copy of an award issued in
arbitration proceeding carried out in conformity with the terms of the said
Contract that the amount of the damages is payable to the Employer.

Signed on _____ Signed on _____
on behalf of _____ on behalf of _____
by _____ by _____
in the capacity of _____ in the capacity of _____
in the presence of _____ in the presence of _____

EXAMPLE SURETY BOND FOR PERFORMANCE

Know all Men by these Presents that (name and address of Contractor)

_____ as Principal (hereinafter called "the Contractor") and (name, legal title and address of Surety) _____

_____ as Surety (hereinafter called "the Surety"), are held and firmly bound unto (name and address of Employer) _____

_____ as Obligee (hereinafter called "the Employer") in the amount of _____ for the payment of which sum, well and truly to be made, the Contractor and the Surety bind themselves; their successors and assigns, jointly and severally, firmly by these presents.

Whereas the Contractor has entered into a written contract agreement with the Employer dated the _____ day of _____ 19____ for (name of Works) _____ in accordance with the plans and specifications and amendments thereto, to the extent herein provided for, are by reference made part hereof and are hereinafter referred to as the Contract.

Now, therefore, the Condition of this Obligation is such that, if the Contractor shall promptly and faithfully perform the said Contract (including any amendments thereto) then this obligation shall be null and void; otherwise it shall remain in full force and effect.

Whenever Contractor shall be, and declared by Employer to be, in default under the Contract, the Employer having performed the Employer's obligations thereunder, the Surety may promptly remedy the default, or shall promptly:

- (1) Complete the Contract in accordance with its terms and conditions; or
- (2) Obtain a bid or bids for submission to the Employer for completing the Contract in accordance with its terms and conditions, and upon determination by Employer and Surety of the lowest responsible bidder, arrange for a contract between such bidder and Employer and make available as work progresses (even though there should be a default or a succession of defaults under the contract or contracts of completion arranged under this paragraph) sufficient funds to pay the cost of completion less the balance of the Contract Value; but not exceeding, including other costs and damages for which the Surety may be liable hereunder, the amount set forth in the first paragraph hereof. The term "balance of the Contract Value", as used in this paragraph, shall mean the total amount payable by Employer to Contractor under the Contract, less the amount properly paid by Employer to Contractor; or
- (3) Pay the Employer the amount required by Employer to complete the Contract in accordance with its terms and conditions any amount up to a total not exceeding the amount of this Bond.

The Surety shall not be liable for a greater sum than the specified penalty of this Bond.

Any suit under this Bond must be instituted before the issue of the Defects Liability Certificate.

No right of action shall accrue on this Bond to or for the use of any person or corporation other than the Employer named herein or the heirs, executors, administrators or successors of the Employer.

Signed on _____ Signed on _____
on behalf of _____ on behalf of _____
by _____ by _____
in the capacity of _____ in the capacity of _____
in the presence of _____ in the presence of _____

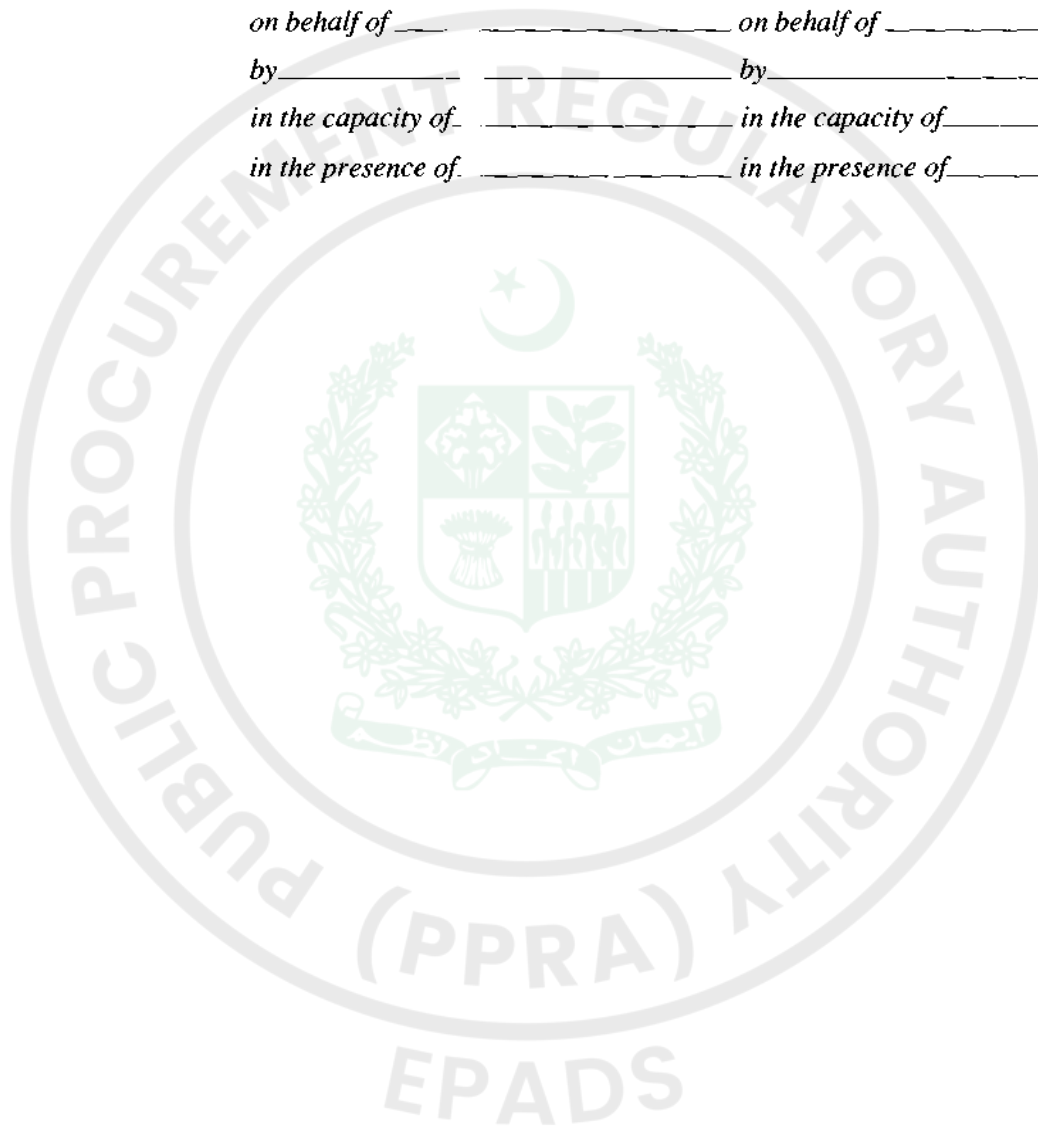

Clause 15

Where the language in which the Contract documents have been drawn up is not the language of the country in which the Works are to be executed, or where for any other reason it is necessary to stipulate that the Contractor's authorised representative shall be fluent in a particular language, an additional Sub-Clause may be added.

EXAMPLE SUB-CLAUSES

Language Ability of Contractor's Representative 15.2 *The Contractor's authorised representative shall be fluent in (insert name of language).*

or

Interpreter to be Made Available 15.2 *If the Contractor's authorised representative is not, in the opinion of the Engineer, fluent in (insert name of language), the Contractor shall have available on Site at all times a competent interpreter to ensure the proper transmission of instructions and information.*

Clause 16

Where the language in which the Contract documents have been drawn up is not the language of the country in which the Works are to be executed, or where for any other reason it is necessary to stipulate that members of the Contractor's superintending staff shall be fluent in a particular language, an additional Sub-Clause may be added.

EXAMPLE SUB-CLAUSE

Language Ability of Superintending Staff 16.3 *A reasonable proportion of the Contractor's superintending staff shall have a working knowledge of (insert name of language) or the Contractor shall have available on Site at all times a sufficient number of competent interpreters to ensure the proper transmission of instructions and information.*

Where there is a desire, but not a legal requirement, that the Contractor makes reasonable use of materials from or persons resident in the country in which the Works are to be executed, an additional Sub-Clause may be added.

EXAMPLE SUB-CLAUSE

Employment of Local Personnel 16.4 *The Contractor is encouraged, to the extent practicable and reasonable, to employ staff and labour from sources within (insert name of country).*

Clause 18

Sub-Clause 18.1 – Boreholes and Exploratory Excavation

For a Contract comprising dredging and reclamation work the Sub-Clause may require to be varied.

EXAMPLE

Add second sentence as follows:

Such exploratory excavation shall be deemed to include dredging.

Clause 19

Sub-Clause 19.1 – Safety, Security and Protection of the Environment

Where a Contract includes dredging the possibility of pollution should be given particular attention and additional wording may be required. For example, where fishing and recreation areas might be influenced, the Contractor should be required to plan and execute the dredging so that the effect is kept to a minimum. Where there is a risk of chemical pollution from soluble sediments in the dredging area, for instance in a harbour, it is important that sufficient information is provided with the Tender documents. Responsibilities should be clearly defined.

Clause 21

Sub-Clause 21.1 – Insurance of Works and Contractor's Equipment

Where there is provision in the Contract for payments to the Contractor to be made in foreign currency, this Sub-Clause may be varied.

EXAMPLE

Add final sentence as follows:

The insurance in paragraphs (a) and (b) shall provide for compensation to be payable in the types and proportions of currencies required to rectify the loss or damage incurred.

Where it is decided to state the deductible limits for the Employer's Risks, this Sub-Clause may be varied.

EXAMPLE

Add to paragraph (a) as follows:

and with deductible limits for the Employer's Risks not exceeding (insert amounts)

Clauses 21, 23 and 25. Insurances Arranged by Employer

In certain circumstances, such as where a number of separate contractors are employed on a single project, or phased take-over is involved, it may be preferable for the Employer to arrange insurance of the Works, and Third Party insurance. In such case, it must be clear in the Contract that the Contractor is not precluded from taking out any additional insurance, should he desire to do so, over and above that to be arranged by the Employer.

Tenderers must be provided at the Tender stage with details of the insurance to be arranged by the Employer, in order to assess what provision to make in their rates and prices for any additional insurance, and for the amount of policy deductibles which they will be required to bear. Such details shall form part of the Contract between the Employer and the Contractor.

Example wording to allow for the arrangement of insurance by the Employer is as follows:

EXAMPLE

Clause 21

Delete the text of the Clause and substitute the following re-numbered Sub-Clauses:

- Insurance of Works 21.1** *Without limiting his or the Contractor's obligations and responsibilities under Clause 20, the Employer will insure:*
- (a) the Works, together with materials and Plant for incorporation therein, to the full replacement cost (the term "cost" in this context shall include profit), and*
 - (b) an additional sum to cover any additional costs of and incidental to the rectification of loss or damage including professional fees and the cost of demolishing and removing any part of the Works and of removing debris of whatsoever nature.*
- Insurance of Contractor's Equipment 21.2** *The Contractor shall, without limiting his obligations and responsibilities under Clause 20, insure the Contractor's Equipment and other things brought onto the site by the Contractor, for a sum sufficient to provide for their replacement at the Site.*
- Scope of Cover 21.3** *The insurance in Sub-Clause 21.1 shall be in the joint names of the Contractor and the Employer and shall cover:*

(a) the Employer and the Contractor against loss or damage as provided in the details of insurance annexed to these Conditions, from the start of work at the Site until the date of issue of the relevant Taking-Over Certificate in respect of the Works or any Section or part thereof as the case may be, and

(b) the Contractor for his liability:

(i) during the Defects Liability Period for loss or damage arising from a cause occurring prior to the commencement of the Defects Liability Period, or

(ii) occasioned by the Contractor in the course of any operations carried out by him for the purpose of complying with his obligations under Clauses 49 and 50.

Responsibility for Amounts not Recovered 21.4 Any amounts not insured or not recovered from the insurers shall be borne by the Employer or the Contractor in accordance with their responsibilities under Clause 20.

Clause 23

Delete the text of the Clause and substitute:

Third Party Insurance (including Employer's Property) 23.1 Without limiting his or the Contractor's obligations and responsibilities under Clause 22, the Employer will insure in the joint names of the Contractor and the Employer, against liabilities for death of or injury to any person (other than as provided in Clause 24) or loss of or damage to any property other than the Works) arising out of the performance of the Contract, as provided in the details of insurance referred to in Sub-Clause 21.3.

Clause 25

Delete the text of the Clause and substitute:

Evidence and Terms of Insurances 25.1 The insurance policies to be arranged by the Employer pursuant to Clauses 21 and 23 shall be consistent with the general terms described in the Tender and copies of such policies shall when required be supplied by the Employer to the Contractor.

Adequacy of Insurances 25.2 The Employer shall notify the insurers of changes in the nature, extent or programme for execution of the Works and ensure the adequacy of the insurances at all times in accordance with the terms of the Contract and shall, when required, produce to the Contractor the insurance policies in force and the receipts for payment of the premiums. No variations shall be made to the insurances by the Employer without the prior approval of the Contractor.

Remedy on Employer's Failure to Insure 25.3 If and so far as the Employer fails to effect and keep in force any of the insurances referred to in Sub-Clause 25.1, then the Contractor may effect and keep in force any such insurance and pay any premium as may be necessary for that purpose and add the amount so paid to any monies due or to become due to the Contractor, or recover the same as a debt due from the Employer.

Compliance with Policy Conditions 25.4 In the event that the Contractor or the Employer fails to comply with conditions imposed by the insurance policies effected pursuant to the Contract, each shall indemnify the other against all losses and claims arising from such failure.

Clause 28

Sub-Clause 28.2 – Royalties

For a Contract comprising dredging and reclamation work and for any other Contract involving the dumping of materials the Sub-Clause may require to be varied.

EXAMPLE

Add second sentence as follows:

The Contractor shall also be liable for all payments or compensation, if any, levied in relation to the dumping of part or all of any such materials.

It is sometimes the case on dredging contracts for the Employer to bear the costs of tonnage and other royalties, rent and other payments or compensation. If such conditions are to apply, Sub-Clause 28.2 should be varied either by adding wording or by deleting the existing wording and substituting new wording.

Clause 31

Where the particular requirements of other contractors are known within reasonable limits at the time of preparation of the Contract documents, details must be stated. The Specification is usually the appropriate place to do so but, exceptionally, some reference may be desirable in the Conditions. In that case, an additional Sub-Clause or Sub-Clauses could be added to this Clause.

Clause 34

It will generally be necessary to add a number of Sub-Clauses, to take account of the circumstances and locality of the Works, covering such matters as: permits and registration of expatriate employees; repatriation to place of recruitment; provision of temporary housing for employees; requirements in respect of accommodation for staff of Employer and Engineer; standards of accommodation to be provided; provision of access roads, hospital, school, power, water, drainage, fire services, refuse collection, communal buildings, shops, telephones; hours and conditions of working; rates of pay; compliance with labour legislation; maintenance of records of safety and health.

EXAMPLE SUB-CLAUSES (to be numbered, as appropriate)

Rates of Wages and Conditions of Labour 34. *The Contractor shall pay rates of wages and observe conditions of labour not less favourable than those established for the trade or industry where the work is carried out. In the absence of any rates of wages or conditions of labour so established, the Contractor shall pay rates of wages and observe conditions of labour which are not less favourable than the general level of wages and conditions observed by other employers whose general circumstances in the trade or industry in which the Contractor is engaged are similar.*

Employment of Persons in the Service of Others 34. *The Contractor shall not recruit or attempt to recruit his staff and labour from amongst persons in the service of the Employer or the Engineer.*

Repatriation of Labour 34. *The Contractor shall be responsible for the return to the place where they were recruited or to their domicile of all such persons as he recruited and employed for the purposes of or in connection with the Contract and shall maintain such persons as are to be so returned in a suitable manner until they shall have left the Site or, in the case of persons who are not nationals of and have been recruited outside (insert name of country), shall have left (insert name of country).*

Housing for Labour 34. *Save insofar as the Contract otherwise provides, the Contractor shall provide and maintain such accommodation and amenities as he may consider necessary for all his staff and labour, employed for the purposes of or in connection with the Contract, including all fencing, water supply (both for drinking and other purposes), electricity supply, sanitation, cookhouses, fire prevention and fire-fighting equipment, air conditioning, cookers, refrigerators, furniture and other requirements in connection with such accommodation or amenities. On completion of the Contract, unless otherwise agreed with the Employer, the temporary camps/housing provided by the Contractor shall be removed and the site reinstated to its original condition, all to the approval of the Engineer.*

Accident Prevention Officer; Accidents 34. *The Contractor shall have on his staff at the Site an officer dealing only with questions regarding the safety and protection against accidents of all staff and labour. This officer shall be qualified for this work and shall have the authority to issue instructions and shall take protective measures to prevent accidents.*

- Health and Safety** 34. *Due precautions shall be taken by the Contractor, and at his own cost, to ensure the safety of his staff and labour and, in collaboration with and to the requirements of the local health authorities, to ensure that medical staff first aid equipment and stores, sick bay and suitable ambulance service are available at the camps, housing and on the Site at all times throughout the period of the Contract and that suitable arrangements are made for the prevention of epidemics and for all necessary welfare and hygiene requirements.*
- Measures against Insect and Pest Nuisance** 34. *The Contractor shall at all times take the necessary precautions to protect all staff and labour employed on the site from insect nuisance, rats and other pests and reduce the dangers to health and the general nuisance occasioned by the same. The Contractor shall provide his staff and labour with suitable prophylactics for the prevention of malaria and take steps to prevent the formation of stagnant pools of water. He shall comply with all the regulations of the local health authorities in these respects and shall in particular arrange to spray thoroughly with approved insecticide all buildings erected on the Site. Such treatment shall be carried out at least once a year or as instructed by the Engineer. The Contractor shall warn his staff and labour of the dangers of bilharzia and wild animals.*
- Epidemics** 34. *In the event of any outbreak of illness of an epidemic nature, the Contractor shall comply with and carry out such regulations, orders and requirements as may be made by the Government, or the local medical or sanitary authorities, for the purpose of dealing with and overcoming the same.*
- Burial of the Dead** 34. *The Contractor shall make all necessary arrangements for the transport, to any place as required for burial, of any of his expatriate employees or members of their families who may die in (insert name of country). The Contractor shall also be responsible, to the extent required by the local regulations, for making any arrangements with regard to burial of any of his local employees who may die while engaged upon the Works.*
- Supply of Foodstuffs** 34. *The Contractor shall arrange for the provision of a sufficient supply of suitable food at reasonable prices for all his staff, labour and Subcontractors, for the purposes of or in connection with the Contract.*
- Supply of Water** 34. *The Contractor shall, so far as is reasonably practicable, having regard to local conditions, provide on the Site an adequate supply of drinking and other water for the use of his staff and labour.*
- Alcoholic Liquor or Drugs** 34. *The Contractor shall not, otherwise than in accordance with the Statutes, Ordinances and Government Regulations or Orders for the time being in force, import, sell, give, barter or otherwise dispose of any alcoholic liquor or drugs, or permit or suffer any such importation, sale, gift, barter or disposal by his Subcontractors, agents, staff or labour.*
- Arms and Ammunition** 34. *The Contractor shall not give, barter or otherwise dispose of to any person or persons, any arms or ammunition of any kind or permit or suffer the same as aforesaid.*
- Festivals and Religious Customs** 34. *The Contractor shall in all dealings with his staff and labour have due regard to all recognised festivals, days of rest and religious or other customs.*
- Disorderly Conduct** 34. *The Contractor shall at all times take all reasonable precautions to prevent any unlawful, riotous or disorderly conduct by or amongst his staff and labour and for the preservation of peace and protection of persons and property in the neighbourhood of the Works against the same.*

Clause 35

Additional Sub-Clauses may be desirable to cover circumstances which require the maintenance of particular records or the provision of certain specific reports.

- Records of Safety and Health** 35. *EXAMPLE SUB-CLAUSES (to be numbered, as appropriate)*
The Contractor shall maintain such records and make such reports concerning safety, health and welfare of persons and damage to property as the Engineer may from time to time prescribe.
- Reporting of Accidents** 35. *The Contractor shall report to the Engineer details of any accident as soon as possible after its occurrence. In the case of any fatality or serious accident, the Contractor shall, in addition, notify the Engineer immediately by the quickest available means.*

Clause 40

For a Contract comprising dredging and some types of reclamation work the Clause may be varied.

Sub-Clause 40.1 – Suspension of Work

EXAMPLE

Delete paragraph (c) and renumber paragraph (d) as (c).

Sub-Clause 40.3 – Suspension Lasting more than 84 Days

EXAMPLE

In the first sentence delete the words “, (c) or (d)” and substitute “or (c)”.

Clause 43

Sub-Clause 43.1 – Time for Completion

Where completion is stated to be by a date and not within a period of time, the Sub-Clause will require to be varied.

EXAMPLE

Delete the words, “within the time... such extended time” and substitute “by the date or dates stated in the Appendix to Tender for the whole of the Works or the Section (as the case may be) or such later date or dates”.

Clause 45

For a Contract located in an isolated area, where environmental restrictions do not apply, or where a Contract comprises work, such as dredging and reclamation, that may require continuous working, the Clause may be varied.

EXAMPLE

Delete Sub-Clause 45.1 and substitute:

- Working Hours** 45.1 *Subject to any provision to the contrary contained in the Contract, the Contractor shall have the option to work continuously by day and by night and on locally recognised days of rest.*

The Contractor's option may be further extended by substituting, in place of the last three words:

holidays or days of rest.

Clause 47

Where it is desired to make provision for the payment of a bonus or bonuses for early completion, an additional Sub-Clause may be added.

In the case where a bonus is provided for early completion of the whole of the Works:

Bonus for Completion 47.3 **EXAMPLE SUB-CLAUSE**
If the Contractor achieves completion of the Works prior to the time prescribed by Clause 43, the Employer shall pay to the Contractor a sum of (insert figure) for every day which shall elapse between the date stated in the Taking-Over Certificate in respect of the Works issued in accordance with Clause 48 and the time prescribed in Clause 43.

or

In the case where bonuses are provided for early completion of Sections of the Works and details, other than the dates, are given in the Specification:

Bonus for Completion 47.3 **EXAMPLE SUB-CLAUSE**
Sections are required to be completed by the dates given in the Appendix to Tender in order that such Sections may be occupied and used by the Employer in advance of the completion of the whole of the Works.
Details of the work required to be executed to entitle the Contractor to bonus payments and the amount of the bonuses are stated in the Specification.
For the purposes of calculating bonus payments, the dates given in the Appendix to Tender for completion of Sections are fixed and, unless otherwise agreed, no adjustments of the dates by reason of granting an extension of time pursuant to Clause 44 or any other Clause of these Conditions will be allowed.
Issue of certificates by the Engineer that the Sections were satisfactory and complete by the dates given on the certificates shall, subject to Clause 60, entitle the Contractor to the bonus payments calculated in accordance with the Specification.

Clause 48

Where it can be foreseen that, when the whole of the Works have been substantially completed, the Contractor may be prevented by reasons beyond his control from carrying out the Tests on Completion, an additional Sub-Clause may be added.

Prevention from Testing 48.5 **EXAMPLE SUB-CLAUSE**
If the Contractor is prevented from carrying out the Tests on Completion by a cause for which the Employer or the Engineer or other contractors employed by the Employer are responsible, the Employer shall be deemed to have taken over the Works on the date when the Tests on Completion would have been completed but for such prevention. The Engineer shall issue a Taking-Over Certificate accordingly. Provided always that the Works shall not be deemed to have been taken over if they are not substantially in accordance with the Contract.
If the Works are taken over under this Sub-Clause the Contractor shall nevertheless carry out the Tests on Completion during the Defects Liability Period. The Engineer shall require the Tests to be carried out by giving 14 days notice.
Any additional costs to which the Contractor may be put, in making the Tests on Completion during the Defects Liability Period, shall be added to the Contract Price.

Clause 49

For a Contract which includes a high proportion of Plant, an additional Sub-Clause may be necessary.

Extension of Defects Liability 49.5

EXAMPLE SUB-CLAUSE

The provisions of this Clause shall apply to all replacements or renewals of Plant carried out by the Contractor to remedy defects and damage as if the replacements and renewals had been taken over on the date they were completed. The Defects Liability Period for the Works shall be extended by a period equal to the period during which the Works cannot be used by reason of a defect or damage. If only part of the Works is affected the Defects Liability Period shall be extended only for that part. In neither case shall the Defects Liability Period extend beyond 2 years from the date of taking over.

When progress in respect of Plant has been suspended under Clause 40, the Contractor's obligations under this Clause shall not apply to any defects occurring more than 3 years after the Time for Completion established on the date of the Letter of Acceptance.

For a Contract comprising dredging work an additional Sub-Clause may be added.

No Remedying of Defects in Dredging Work after Completion 49.5

EXAMPLE SUB-CLAUSE

Notwithstanding Sub-Clause 49.2, the Contractor shall have no responsibility for the remedying of defects, shrinkages or other faults in respect of dredging work after the date stated in the Taking-Over Certificate.

Clause 50

For a Contract comprising dredging work and where the second Example Sub-Clause 49.5 has been adopted, an additional Sub-Clause should be added.

No Responsibility for Cost of Searching of Dredging Work 50.2

EXAMPLE SUB-CLAUSE

Notwithstanding Sub-Clause 50.1, the Contractor shall have no responsibility to bear the cost of searching for any defect, shrinkage or other fault in respect of dredging work after the date stated in the Taking-Over Certificate.

Clause 51

Sub-Clause 51.1 – Variations

For a Contract comprising dredging and some types of reclamation work the Sub-Clause may require to be varied.

EXAMPLE

Add final sentence as follows:

Provided also that the Contractor shall be under no obligation to execute any variation which cannot be executed by the Contractor's Equipment being used or to be used on the Works.

Clause 52

Where provision is made in the Contract for payment in foreign currency, this Clause may be varied.

Sub-Clause 52.1 – Valuation of Variations

EXAMPLE

Add final sentence as follows:

The agreement, fixing or determination of any rates or prices as aforesaid shall include any foreign currency and the proportion thereof.

Sub-Clause 52.2 – Power of Engineer to Fix Rates

Add to first paragraph final sentence as follows:

The agreement or fixing of any rates or prices as aforesaid shall include any foreign currency and the proportion thereof.

Sub-Clause 52.3 – Variations Exceeding 15 per cent

Add final sentence as follows:

The adjustment or fixing of any sum as aforesaid shall have due regard to any foreign currency included in the Effective Contract Price and the proportion thereof.

Where it is required to place some limitation on the range of items for which the rates and prices may be subject to review, the Clause may be varied.

Sub-Clause 52.2 – Power of Engineer to Fix Rates

EXAMPLE

At the end of the first paragraph add:

Provided further that no change in the rate or price for any item contained in the Contract shall be considered unless such item accounts for an amount more than 2 per cent of the Contract Price, and the actual quantity of work executed under the item exceeds or falls short of the quantity set out in the Bill of Quantities by more than 25 per cent.

Clause 54

Where vesting of Contractor's Equipment, Temporary Works and materials in the Employer is required, additional Sub-Clauses may be added.

EXAMPLE WORDING AND SUB-CLAUSES

Sub-Clauses 54.2 and 54.3 shall be renumbered as 54.3 and 54.4 and Sub-Clauses 54.4 to 54.8 shall be renumbered as 54.6 to 54.10. Add additional Sub-Clauses as follows:

Vesting 54.2 *All Contractor's Equipment, Temporary Works and materials owned by the Contractor, or by any company in which the Contractor has a controlling interest, shall, when on the Site, be deemed to be the property of the Employer. Provided always that the vesting of such property in the Employer shall not prejudice the right of the Contractor to the sole use of the said Contractor's Equipment, Temporary Works and materials for the purpose of the Works nor shall it affect the Contractor's responsibility to operate and maintain the same under the provisions of the Contract.*

Revesting and Removal 54.5 *Upon the removal, with the consent of the Engineer under Sub-Clauses 54.1, of any such Contractor's Equipment, Temporary Works or materials as have been deemed to have become the property of the Employer under Sub-Clause 54.2, the property therein shall be deemed to revest in the Contractor and, upon completion of the Works, the property in the remainder of such Contractor's Equipment, Temporary Works and materials shall, subject to Clause 63, be deemed to revest in the Contractor.*

Clause 60

Additional Sub-Clauses may be necessary to cover certain other matters relating to payments.

Where payments are to be made in various currencies in predetermined proportions and calculated at fixed rates of exchange the following 3 Sub-Clauses, which should be taken together, may be added:

- Currency of Account and Rates of Exchange** 60. **EXAMPLE SUB-CLAUSES** (to be numbered, as appropriate)
The currency of account shall be the (insert name of currency) and for the purposes of the Contract conversion between (insert name of currency) and other currencies stated in the Appendix to Tender shall be made in accordance with the Table of Exchange Rates in the Appendix to Tender. Conversion between the currencies stated in such Table other than the (insert name of currency) shall be made at rates of exchange determined by use of the relative rates of exchange between such currencies and the (insert name of currency) set out therein.
- Payments to Contractor** 60. *All payments to the Contractor by the Employer shall be made :*
(a) in the case of payment(s) under Sub-Clause(s) 70.2 and (insert number of any other applicable Clause), in (insert name of currency/ies);
(b) in the case of payments for certain provisional sum items excluded from the Appendix to Tender, in the currencies and proportions applicable to these items at the time when the Engineer gives instructions for the work covered by these items to be carried out; and
(c) in any other case, including Increase or Decrease of Costs under Sub-Clause 70.1, in the currencies and proportions stated in the Appendix to Tender as applicable to such payment provided that the proportions of currencies stated in the Appendix to Tender may from time to time upon the application of either party be varied as may be agreed.
- Payments to Employer** 60. *All payments to the Employer by the Contractor including payments made by way of deduction or set-off shall be made :*
(a) in the case of credit(s) under Sub-Clause(s) 70.2 and (insert number of any other applicable Clause) in (insert name of currency/ies);
(b) in the case of liquidated damages under Clause 47, in (insert name of currency/ies);
(c) in the case of reimbursement of any sum previously expended by the Employer, in the currency in which the sum was expended by the Employer; and
(d) in any other case, in such currency as may be agreed.
If the part payable in a particular currency of any sum payable to the Contractor is wholly or partly insufficient to satisfy by way of deduction or set-off a payment due to the Employer in that currency, in accordance with the provisions of this Sub-Clause, then the Employer may if he so desires make such deduction or set-off wholly or partly as the case may be from the balance of such sum payable in other currencies.

Where all payments are to be made in one currency the following Sub-Clause may be added:

- Currency of Account and Payments** 60. **EXAMPLE SUB-CLAUSE** (to be numbered, as appropriate)
The currency of account shall be the (insert name of currency) and all payments made in accordance with the Contract shall be in (insert name of currency). Such (insert name of currency), other than for local costs, shall be fully convertible. The percentage of such payments attributed to local costs shall be as stated in the Appendix to Tender.

Where place of payment is to be defined the following Sub-Clause may be added:

Place of Payment 60. EXAMPLE SUB-CLAUSE (to be numbered, as appropriate)
Payments to the Contractor by the Employer shall be made into a bank account nominated by the Contractor in the country of the currency of payment. Where payment is to be made in more than one currency separate bank accounts shall be nominated by the Contractor in the country of each currency and payments shall be made by the Employer accordingly.

Where provision is to be included for an advance payment the following Sub-Clause may be added:

Advance Payment 60. EXAMPLE SUB-CLAUSE (to be numbered, as appropriate)
An advance payment of the amount stated in the Appendix to Tender shall, following the presentation by the Contractor to the Employer of an approved performance security in accordance with Sub-Clause 10.1 and a Guarantee in terms approved by the Employer for the full value of the advance payment, be certified by the Engineer for payment to the Contractor. Such Guarantee shall be progressively reduced by the amount repaid by the Contractor as indicated in Interim Payment Certificates of the Engineer issued in accordance with this Clause. The advance payment shall not be subject to retention. The advance payment shall be repaid by way of reduction in Interim Payment Certificates commencing with the next certificate issued after the total certified value of the Permanent Works and any other items in the Bill of Quantities (excluding the deduction of retention) exceeds (insert figure) per cent of the sum stated in the Letter of Acceptance. The amount of the reduction in each Interim Payment Certificate shall be one (insert fraction) of the difference between the total value of the Permanent Works and any other items in the Bill of Quantities (excluding the deduction of retention) due for certification in such Interim Payment Certificate and the said value in the last preceding Interim Payment Certificate until the advance payment has been repaid in full. Provided that upon the issue of a Taking-Over Certificate for the whole of the Works or upon the happening of any of the events specified in Sub-Clause 63.1 or termination under Clauses 65, 66 or 69, the whole of the balance then outstanding shall immediately become due and payable by the Contractor to the Employer.

Clause 67

Where it is considered desirable to add to Sub-Clauses 67.3 provisions with respect to the number of arbitrators, the place of arbitration and the language of arbitration, the following paragraphs may be added to Sub-Clause 67.3:

EXAMPLE

The arbitral tribunal shall consist of (a sole or three) arbitrator(s).

The place of arbitration shall be(city and country).

The language of the arbitration shall be.....

It is desirable that the place of arbitration be situated in a state, other than that of the Employer or the Contractor, which has a modern and liberal arbitration law and which has ratified a bilateral or multilateral convention (such as the 1958 New York Convention on the Recognition and Enforcement of Foreign Arbitral Awards), or both, that would facilitate the enforcement of an arbitral award in the states of the parties to the Contract.

In the absence of stipulations as to the three above mentioned matters, (number of arbitrators, place of arbitration and language of arbitration), the ICC will decide on the number of arbitrators (typically three in any substantial construction dispute) and on the place of arbitration. The arbitral tribunal will decide on the language of the arbitration if the parties cannot agree.

It may also be considered desirable in some cases for other parties to be joined into any arbitration between the Employer and the Contractor, thereby creating a multi-party arbitration. While this may be feasible, multi-party arbitration clauses require skillful draftmanship on a case-by-case basis. No satisfactory standard form of multi-party arbitration clause for international use has yet been developed.

Where it is decided that a settlement of dispute procedure, other than that of the International Chamber of Commerce (ICC), should be used the Clause may be varied.

Sub-Clause 67.3 – Arbitration

EXAMPLE

Following paragraph (b), delete the words “shall be finally settled... International Chamber of Commerce” and substitute “shall be finally settled under the UNCITRAL Arbitration Rules as administered by (insert name of administering authority)”.

Where alternatives to the ICC are considered care should be taken to establish that the favoured alternative is appropriate for the circumstances of the Contract and that the wording of Clause 67 is checked and amended as may be necessary to avoid any ambiguity with the alternative. Care should be taken to define exactly how the arbitral tribunal is to be appointed and, where appropriate, an appointing authority should be designated.

Clause 68

Sub-Clause 68.2 – Notice to Employer and Engineer

For the purposes of this Sub-Clause the respective addresses are:

(a) The Employer (insert address)

(b) The Engineer (insert address)

The addresses should be inserted when the documents are being prepared prior to inviting tenders.

Clause 69

Sub-Clause 69.1 – Default of Employer

Where the Employer is a government it may be considered appropriate to vary the Sub-Clause.

EXAMPLE

Delete paragraph (c) and renumber paragraph (d) as (c).

Where the terms of the Sub-Clause, when read in conjunction with Sub-Clause 69.3, are in conflict with the law of the country the Sub-Clause may require to be varied.

EXAMPLE

Delete “or” at the end of paragraph (c) and delete paragraph (d).

Clause 70

Three alternative methods of dealing with price adjustment are given below.

The first alternative is suitable where a contract is of short duration and no price adjustment is to be made:

Sub-Clause 70.1—Increase or Decrease in Cost

EXAMPLE

Delete the text of the Sub-Clause and substitute

Subject to Sub-Clause 70.2, the Contract Price shall not be subject to any adjustment in respect of rise or fall in the cost of labour, materials or any other matters affecting the cost of execution of the Contract.

Sub-Clause 70.2—Subsequent Legislation

EXAMPLE

Delete the words “, other than under Sub-Clause 70.1, ”.

The second alternative is suitable where price adjustment is to be made by establishing the difference in cost between the basic price and the current price of local labour and specified materials:

Sub-Clause 70.1—Increase or Decrease in Cost

EXAMPLE

Delete the text of the Sub-Clause and substitute

Adjustments to the Contract Price shall be made in respect of rise or fall in the cost of local labour and specified materials as set out in this Sub-Clause.

(a) Local Workmen

(i) For the purpose of this Sub-Clause:

“Local Workmen” means skilled, semi-skilled and unskilled workmen of all trades engaged by the Contractor on the Site for the purpose of or in connection with the Contract or engaged full time by the Contractor off the Site for the purpose of or in connection with the Contract (by way of illustration but not limitation: workmen engaged full time in any office, store, workshop or quarry);

“Basic Rate” means the applicable basic minimum wage rate prevailing on the date 28 days prior to the latest date for submission of tenders by reason of any National or State Statute, Ordinance, Decree or other Law or any regulations or bye-law of any local or other duly constituted authority, or in order to conform with practice amongst good employers generally in the area where the Works are to be carried out; and

“Current Rate” means the applicable basic minimum wage rate for Local Workmen prevailing on any date subsequent to the date 28 days prior to the latest date set for submission of tenders by reason of any National or State Statute, Ordinance, Decree or other Law or any regulation or bye-law of any local or other duly constituted authority, or in order to conform with practice amongst good employers generally in the area where the works are to be carried out.

(ii) The adjustment to the Contract Price under the terms of this Sub-Clause shall be calculated by multiplying the difference between the Basic and Current Rates for Local workmen by:

(a) the number of all hours actually worked, and

(b) in respect of those hours worked at overtime rates, by the product of the number of said hours and the percentage addition required by the law to be paid by the Contractor for overtime.

Such adjustment may be either an addition to or a deduction from the Contract Price.

(iii) No other adjustment of the Contract Price on account of fluctuation in the remuneration of Local Workmen shall be made.

(b) Specified Materials

(i) For the purpose of this Sub-Clause:

“Specified Materials” means the materials stated in Appendix (insert reference) to Tender required on the Site for the execution and completion of the Works;

“Basic Prices” means the current prices for the specified materials prevailing on the date 28 days prior to the latest date for submission of tenders; and

“Current Prices” means the current prices for the specified materials prevailing at any date subsequent to the date 28 days prior to the latest date for submission of tenders.

(ii) The adjustment to the Contract Price under the terms of this Sub-Clause shall be calculated by applying the difference between the Basic and Current Prices to the quantity of the appropriate Specified Material which is delivered to the Site during the period for which the particular Current Price is effective. Such adjustment may be either an addition to or a deduction from the Contract Price.

(iii) *The Contractor shall use due diligence to ensure that excessive wastage of the Specified Materials shall not occur. Any Specified Materials removed from the Site shall be clearly identified in the records required under paragraph (d) of this Sub-Clause.*

(iv) *The provisions of this Sub-Clause shall apply to fuels used in Contractor's Equipment engaged on the Site for the purposes of executing the Works, including vehicles owned by the Contractor (or hired by him under long term arrangements under which the Contractor is obligated to supply fuel) engaged in transporting any staff, labour, Contractor's Equipment, Temporary Works, Plant or materials to and from the Site. Such fuels shall be clearly identified in the records required under paragraph (d) of this Sub-Clause. The provisions of this Sub-Clause shall not apply to any fuels sold or supplied to any employee of the Contractor or to any person for use in any motor vehicle not being used for the purposes of the Contract.*

(v) *The Contractor shall at all times have regard to suitable markets and shall, whenever buying materials a variation in the cost of which would give rise to an adjustment of the Contract Price under this Sub-Clause, be diligent to buy or procure the same at the most economical prices as are consistent with the due performance by the Contractor of his obligations under the Contract.*

If at any time there shall have been any lack of diligence, default or negligence on the part of the Contractor, whether in observing the above requirements or otherwise, then, for the purposes of adjusting the Contract Price pursuant hereto, no account shall be taken of any increase in cost which may be attributable to such lack of diligence, default or negligence and the amount by which any cost would have been decreased but for such lack of diligence, default or negligence shall be deducted from the Contract Price.

(vi) *No other adjustment to the Contract Price on account of fluctuation in the cost of materials shall be made.*

(c) Overheads and Profits Excluded

In determining the amount of any adjustment to the Contract Price pursuant to this Sub-Clause no account shall be taken of any overheads or profits.

(d) Notices and Records

The Contractor shall forthwith, upon the happening of any event which may or may be likely to give rise to adjustment of the Contract Price pursuant to this Sub-Clause, give notice thereof to the Engineer and the Contractor shall keep such books, accounts and other documents and records as are necessary to enable adjustment under this Sub-Clause to be made and shall, at the request of the Engineer, furnish any invoices, accounts, documents or records so kept and such other information as the Engineer may require.

(e) Adjustment after Date of Completion

Adjustment to the Contract Price, after the due date for completion of the whole of the Works pursuant to Clause 43, or after the date of completion of the whole of the Works certified pursuant to Clause 48, shall be made in accordance with Current Rates or Current Prices, as applicable, ruling at the due date for completion or the date stated in the Taking-Over Certificate, whichever is the earlier.

(f) Determination of Adjustment to Contract Price

The amount of any adjustment to the Contract Price pursuant to this Sub-Clause shall be determined by the Engineer in accordance with the foregoing rules.

EXAMPLE APPENDIX TO TENDER

for use in conjunction with the second alternative.

SPECIFIED MATERIALS

MATERIAL	UNIT	PRICE AND LOCATION	TRANSPORT TO SITE	PRICE DELIVERED TO SITE	REMARKS
Bitumen					
Diesel					
Petrol					
Lubricants					
Cement					
Reinforcing Steel					
Explosives					

NOTES:

1. The Contractor shall provide copies of quotations to substantiate all prices included in the above table.
2. All subsequent price substantiation shall be from the same source as original unless otherwise agreed by the Engineer.
3. The Contractor shall submit full explanation and provide substantiating documentation for the mode of transport to Site he proposes. Only the proposed documented mode of transport shall qualify for price adjustment.

(Note: Materials stated in the Appendix to Tender should be those of which substantial quantities are involved.)

The third alternative is suitable where price adjustment is to be made through the application of indices in a formula:

Sub-Clause 70.1 – Increase or Decrease in Cost

EXAMPLE

Delete the text of the Sub-Clause and substitute

(a) Adjustments to the Contract Price in respect of rise and fall in the cost of labour and materials and other matters affecting the cost of execution of the Works shall be calculated for each monthly statement pursuant to Sub-Clause 60.1, the Statement at Completion pursuant to Sub-Clause 60.5 and the Final Statement pursuant to Sub-Clause 60.6 in accordance with the provisions of this Sub-Clause if there shall be any changes in the following Index figures compiled by (insert details of source of indices) and published by (insert details of publication):

- (i) the Index of the cost of Labour in (insert name of country),
- (ii) the Index of the cost of (insert other factor, as relevant), or
- (iii) the Index of the cost of (insert other factor, as relevant).

(b) For the purpose of this Sub-Clause:

- (i) "Base Index Figure" shall mean the index figure applicable on the date 28 days prior to the latest date for submission of tenders, and
- (ii) "Current Index Figure" shall mean the index figure applicable on the last day of the period to which the particular statement relates.

Provided that in respect of any work the value of which is included in any such monthly statement (or Statement at Completion or Final Statement) and which was executed after the due date (or extended date) for completion of the whole of the Works, pursuant to Clause 43, the Current Index Figure shall be the index figure applicable on the aforesaid due date (or extended date) for completion of the whole of the Works.

(iii) "Effective Value" shall be the difference between:

(a) The amount which is due to the Contractor under the provisions of Sub-Clauses 60.2, 60.5 or 60.8 (before deducting retention and excluding repayment of the advance payment) less any amounts for:

work executed under nominated Subcontracts

materials and Plant on the Site, as referred to in Sub-Clause 60.1 (c)

dayworks, variations or any other items based on actual cost or current prices, and bonuses (if any)

adjustments under Clause 70,

and

(b) The amount calculated in accordance with (b) (iii) (a) of this Sub-Clause and included in the last preceding statement.

(c) The adjustment to the Contract Price shall be calculated by multiplying the Effective Value by a Price Fluctuation Factor which shall be the net sum of the products obtained by multiplying each of the proportions given in paragraph (d) of this Sub-Clause by the following fraction:

$$\frac{\text{Current Index Figure} - \text{Base Index Figure}}{\text{Base Index Figure}}$$

calculated using the relevant index figures.

(d) For the purpose of calculating the Price Fluctuation Factor, the proportions referred to in paragraph (c) of this Sub-Clause shall (irrespective of the actual constituents of the work) be as follows:

0. in respect of labour (and supervision) costs subject to adjustment by reference to the Index referred to in (a) (i) of this Sub-Clause;
0. in respect of _____ by reference to the Index referred to in (a) (ii) of this Sub-Clause;
0. in respect of _____ by reference to the Index referred to in (a) (iii) of this Sub-Clause;
0. in respect of all other costs which shall not be subject to any adjustment;

1.00 Total

(e) Where the value of an Index is not known at the time of calculation, the latest available value shall be used and any adjustment necessary shall be made in subsequent monthly statements.

(Note: The number of indices included under (a) of this Sub-Clause may be varied, if it is determined that a different number of factors should be separately identified, and in such case (d) of this Sub-Clause must be altered to be consistent.)

Clause 72

Sub-Clause 72.2 – Currency Proportions

Where it is decided that the rate or rates of exchange shall be established from a source other than the Central Bank of the country, the Sub-Clause may be varied.

EXAMPLE

Delete the words from "prevailing..." to the end of the sentence and substitute "stated in the Appendix to Tender".

Clause 73 onwards

Where circumstances require, additional Clauses may be added.

EXAMPLE CLAUSES (to be numbered, starting with Clause 73, as appropriate).

Where the law applicable to the Contract does not cover bribery, the following example Clause may be added.

- Bribes** .1 *If the Contractor or any of his Subcontractors, agents or servants offers to give or agrees to offer or give to any person, any bribe, gift, gratuity or commission as an inducement or reward for doing or forbearing to do any action in relation to the Contract or any other contract with the Employer or for showing or forbearing to show favour or disfavour to any person in relation to the Contract or any other contract with the Employer, then the Employer may enter upon the Site and the Works and terminate the employment of the Contractor and the provisions of Clause 63 hereof shall apply as if such entry and termination had been made pursuant to that Clause.*

Where circumstances require that particular confidentiality is observed, the following example Clause may be added.

- Details to be Confidential** .1 *The Contractor shall treat the details of the Contract as private and confidential, save in so far as may be necessary for the purposes thereof, and shall not publish or disclose the same or any particulars thereof in any trade or technical paper or elsewhere without the previous consent in writing of the Employer or the Engineer. If any dispute arises as to the necessity of any publication or disclosure for the purpose of the Contract the same shall be referred to the Employer whose determination shall be final.*

Where the Contract is being financed wholly or in part by an international financial institution whose rules or policies require a restriction on the use of the funds provided, the following example Clause may be added.

- Expenditure Restricted** .1 *The Contractor shall not make any expenditures for the purpose of the Contract in the territories of any country which is not a member of (insert name of international financial institution) nor shall he make any expenditure for goods produced in or services supplied from such territories.*

Where the Contractor may be a joint venture, the following example Clause may be added.

- Joint and Several Liability** .1 *If the Contractor is a joint venture of two or more persons, all such persons shall be jointly and severally bound to the Employer for the fulfilment of the terms of the Contract and shall designate one of such persons to act as leader with authority to bind the joint venture. The composition or the constitution of the joint venture shall not be altered without the prior consent of the Employer.*

PART II – CONDITIONS OF PARTICULAR APPLICATION

Index	Clause
Access to Data	11.2
Accident Prevention Officer	34.
Accidents, Reporting of	35.
Additional Clauses	73.
Alcoholic Liquor	34.
Arbitration	67.
Arms and Ammunition	34.
Bonus for Completion	47.3
Boreholes and Exploratory Excavation	18.1
Burial of the Dead	34.
Cash Flow Estimate to be Submitted	14.3
Changes in Cost and Legislation	70.
Conditions of Labour and Rates of Wages	34.
Contract Agreement	9.1
Contractor's Equipment, Insurance of	21.1
Contractor's Representative, Language Ability of	15.2
Currency of Account and Rates of Exchange	60.
Currency Proportions	72.2
Data, Access to	11.2
Default of Employer	69.1
Disorderly Conduct	34.
Documents, Order of Precedence	5.2
Drugs	34.
Employer, Name and Address	1.1
Employment of Local Personnel	16.4
Employment of Persons in Service of Others	34.
Engineer, Name and Address	1.1
Engineer's Duties	2.1
Environment, Protection of	19.1
Epidemics	34.
Exploratory Excavation and Boreholes	18.1
Extension of Defects Liability	49.5
Facilities for Other Contractors	31.2
Festivals and Religious Customs	34.
Foodstuffs, Supply of	34.
Health and Safety of Staff and Labour	34.
Housing for Labour	34.
Inspection of Site	11.1
Insurance of the Works and Contractor's Equipment	21.1
Insurances Arranged by the Employer	21.
	23 & 25
Interpreter to be made Available	15.2
Labour, Conditions of and Rates of Wages	34.
Labour, Health and Safety	34.
Labour, Housing for	34.
Labour, Rates of Wages and Conditions	34.
Labour, Repatriation of	34.
Labour, Special Provision for	34.
Language, Ability of Contractor's Representative	15.2

Index	Clause
Language, Ability of Superintending Staff	16.3
Language, Ruling	5.1
Language/s	5.1
Law Applicable	5.1
Local Personnel, Employment of	16.4
Measures Against Insect and Pest Nuisance	34.
No Remedying of Defects in Dredging Work after Completion	49.5
No Responsibility for Cost of Searching of Dredging Work	50.2
Not Foreseeable Physical Obstructions or Conditions	12.2
Notice to Employer and Engineer	68.2
Other Contractors, Facilities for	31.2
Other Contractors, Opportunities for	31.1
Payments to Contractor	60.
Payments to Employer	60.
Performance, Example of Security Bond for	10.1
Performance Guarantee, Example	10.1
Performance Security	10.1
Performance Security, Source of	10.4
Physical Conditions or Obstructions, Not Foreseeable	12.2
Place of Payment	60.
Power of Engineer to Fix Rates	52.2
Prevention from Testing	48.5
Programme to be Submitted	14.1
Protection of the Environment	19.1
Rates of Exchange	60.
Rates of Wages and Conditions of Labour	34.
Records of Safety and Health	35.
Religious Customs and Festivals	34.
Repatriation of Labour	34.
Reporting of Accidents	35.
Revesting and Removal of Contractor's Equipment, Temporary Works and Materials	54.5
Royalties	28.2
Safety, Security and Protection of the Environment	19.1
Security, Safety and Protection of the Environment	19.1
Site, Inspection of	11.1
Source of Performance Security	10.4
Staff, Health and Safety of	34.
Submission of Cash Flow Estimate	14.3
Submission of Programme	14.1
Superintending Staff, Language Ability of	16.3
Supply of Foodstuffs	34.
Supply of Water	34.
Surety Bond for Performance, Example of	10.1
Suspension of Work	40.1
Testing, Prevention from	48.5
Time for Completion	43.1
Valuation of Variations	52.1
Variations	51.1
Variations Exceeding 15 per cent	52.3
Vesting of Contractor's Equipment, Temporary Works and Materials	54.2
Water, Supply of	34.
Working Hours	45.1
Works, Insurance of	21.1

EDITORIAL AMENDMENTS IN 1988

Following publication in 1987 of the Fourth Edition of the Conditions of Contract for Works of Civil Engineering Construction, a number of editorial amendments were agreed by FIDIC. The amendments have been incorporated during reprinting in 1988 and the list below clarifies the differences between the 1988 reprint and the original document.

- Page 5** Clause 9. The words “as stated in Sub-Clause 9.1 of Part 1 of these Conditions” have been added to the final line of the first paragraph.
- Page 6** Sub-Clause 12.2. A comma has been moved from after the word “words” to immediately before the word “other”. The word “Site” has been capitalised.
- Page 7** Example performance guarantee. A comma previously appeared between the words “and” and “complete” in the third line of the paragraph beginning “Whereas”.
The fifth line of the paragraph beginning “Now the Condition . . .” previously read “. . . default by the Contract . . .”
- Page 12** Sub-Clause 21.3. (b) (ii). A full stop has been inserted following “50”.
- Page 13** Sub-Clause 34. Repatriation of Labour. A comma has been inserted between the words “country)” and “shall”.
- Page 14** Sub-Clause 34. Epidemics. The word “Contractor” has been capitalised in the first line.
Sub-Clause 34. Alcoholic Liquor or Drugs. The word “Contractor” has been capitalised in the first line.
- Page 15** Sub-Clause 40.3. This was previously incorrectly listed as 40.2.
- Page 17** Sub-Clause 49.5. The last line of the first paragraph previously read “. . . extend beyond 730 days”.
- Page 20** Sub-Clause 67.3. The word “a” previously appeared before the bracket on the penultimate line of the Example.
- Page 21** Sub-Clause 70.2. A comma has been moved from after the word “words” to immediately before the word “other”.

FURTHER AMENDMENTS IN 1992

The following amendments have been made to the 1988 reprint of the Fourth Edition. In addition, some minor changes in the use of punctuation marks (commas, semicolons, colons and stops), as well as the use of the words “or” and “and” have been introduced to attain uniformity in the style of all Clauses. These minor changes which improve the style, but which have no effect on the meaning of Clauses, have not been listed below.

Contents	The words “Index” and “Editorial Amendments” have been added at the bottom of the page.
Page 1	INTRODUCTION. The words “, subject to minor modifications” have been added, and the word “equally” changed to read “also”.
Page 3	Sub-Clause 1.1. In the last sentence, the words “for example the name of an International Financing Institution (IFI)” have been deleted.
Page 4	Clause 9. In the first paragraph the words “of Part I” have been added. In the second paragraph “I” has been corrected to read “1”.
Page 5	Clause 12. Sub-Clause 12.2. In the title the word “Adverse” has been changed to read “Not Foreseeable” (also amended in the Contents and the Index).
Page 10	Sub-Clause 21.1, sub-para (a). The words “(the term “cost” in this context shall include profit)” have been added.
Page 13	Example Sub-Clause for Supply of Foodstuffs. The words “staff and labour, or his Subcontractors” have been changed to read “staff, labour and Subcontractors”
Page 19	Example Sub-Clause for Advance Payment. The words “interim certificate” have been changed to read “Interim Payment Certificate”, in both the singular and plural. Clause 67. The first four paragraphs of the commentary have been added.
Page 24	Sub-Clause 70.1. In the formula, the word “Based” has been corrected to read “Base”.
Page 25	Example Clause for Bribes. The word “Sub-contractors” has been corrected to read “Subcontractors”. Example Clause for Details to be Confidential. In the sixth line, the words “the decision of” have been deleted. In the seventh line, the word “award” has been changed to read “determination” Example Clause for Expenditure Restricted. In the commentary and text, the leading capital letters on the words “International Financing Institutions” have been changed to small letters. In the commentary, the word “Articles” has been changed to read “rules or policies”. In the third line, the word “not” has been corrected to read “nor”. EDITORIAL AMENDMENTS (1988). In the last item, the words “Line 21” have been corrected to read “Page 21”.

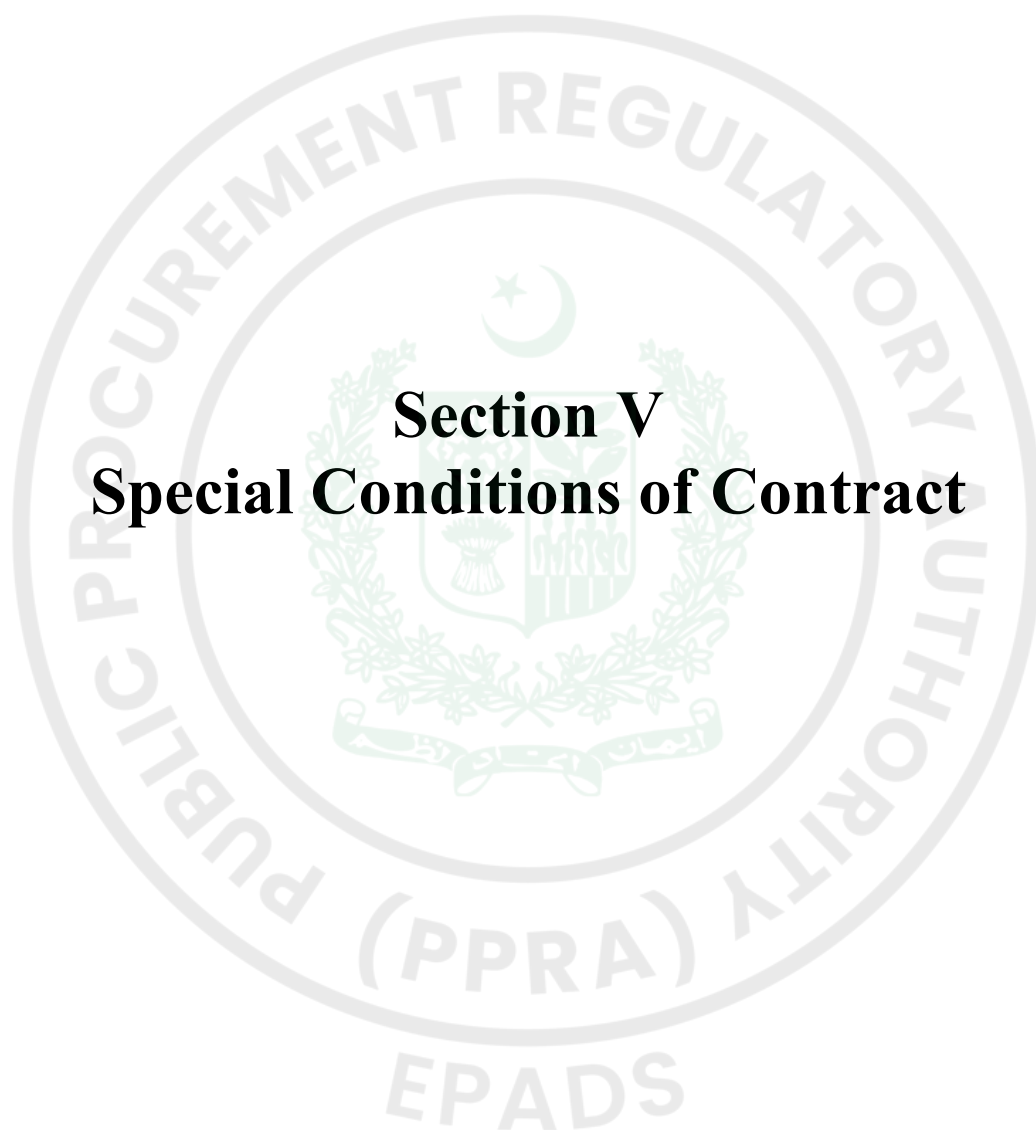

Section V

Special Conditions of Contract

TABLE OF CONTENTS

SPECIAL CONDITIONS OF CONTRACT

Clause	Title	Page
1.1	Definitions	1
2.1	Engineer's Duties and Authority	2
2.3	Engineer's Authority to delegate	3
2.7	Engineer Not Liable	3
2.8	Replacement of the Engineer	3
5.1	Language(s) and Law	3
5.2	Priority of Contract Documents	4
6.1	Custody & supply of Drawing & Document	4
6.6	Shop Drawings	4
6.7	As-Built Drawings	4
10.1	Performance Security	5
10.4	Performance Security Binding on Variations and Changes	5
11.1	Inspection of Site	5
14.1	Programme to be Submitted	6
14.3	Cash Flow Estimate to be Submitted	6
14.5	Monthly Progress Report	7
15.1	Contractor's Superintendence	8
15.2	Language Ability of Contractor's Representative	8
16.3	Language Ability of Superintending Staff of Contractor	8
16.4	Employment of Local Personnel	8
19.3	Safety Precautions	8
19.4	Lighting Works at Night	9
20.4	Employer's Risks	9
21.1	Insurance of Works and Contractor's Equipment	9
21.4	Exclusions	9
25.1	Evidence and Terms of Insurance Covers	9
25.4	Compliance with Policy Conditions	9
25.5	Insurance Company	10
31.3	Co-operation with Other Contractors	10
34.2	Rates of Wages and Conditions of Labour	10
34.3	Employment of Persons in the Service of Others	10
34.4	Housing for Labour	10
34.5	Health and Safety	11
34.6	Epidemics	11
34.7	Supply of Water	11
34.8	Alcoholic Liquor or Drugs	11
34.9	Arms and Ammunition	11
34.10	Festivals and Religious Customs	11
34.11	Disorderly Conduct	11
34.12	Compliance by Subcontractors	12
35.1	Return of Labor & Contractor's Equipment	12
35.2	Records of Safety and Health	12
35.3	Reporting of Accidents	12
36.6	Use of Pakistani Materials and Services	12
41.1	Commencement of Works	12

44.1	Extension of Time for Completion	12
47.3	Bonus for Early Completion of Works	13
48.2	Taking Over of Sections or Parts	13
49.2	Completion of Outstanding Works and Remedying Defects	13
49.5	Extensions of Defects Liability Period	13
51.2	Instructions for Variations	13
52.1	Valuation of Variations	13
53.4	Failure to Comply	13
54.5	Conditions of Hire of Contractor's Equipment	13
59.4	Payments to Nominated Sub-contractors	14
59.5	Certification of Payments & Nominated Subcontractors	14
60.1	Monthly Statements	14
60.2	Monthly Payments	14
60.10	Time for Payment	15
60.11	Secured Advance on Materials	15
60.12	Financial Assistance to Contractor	15
63.1	Default of Contractor	16
65.2	Special Risks	16
67.3	Arbitration	17
68.1	Notices to Contractor	17
68.2	Notices to Employer and Engineer	17
69.0	Default of Employer	17
70.1	Increase or Decrease of Cost	17
73.1	Payment of Income Tax	17
73.2	Customs Duty & Taxes	18
74.1	Integrity Pact	18
75.1	Termination of Contract for Employer's Convenience	18
76.1	Liability of Contractor	18
77.1	Joint and Several Liability	18
78.1	Details to be Confidential	18

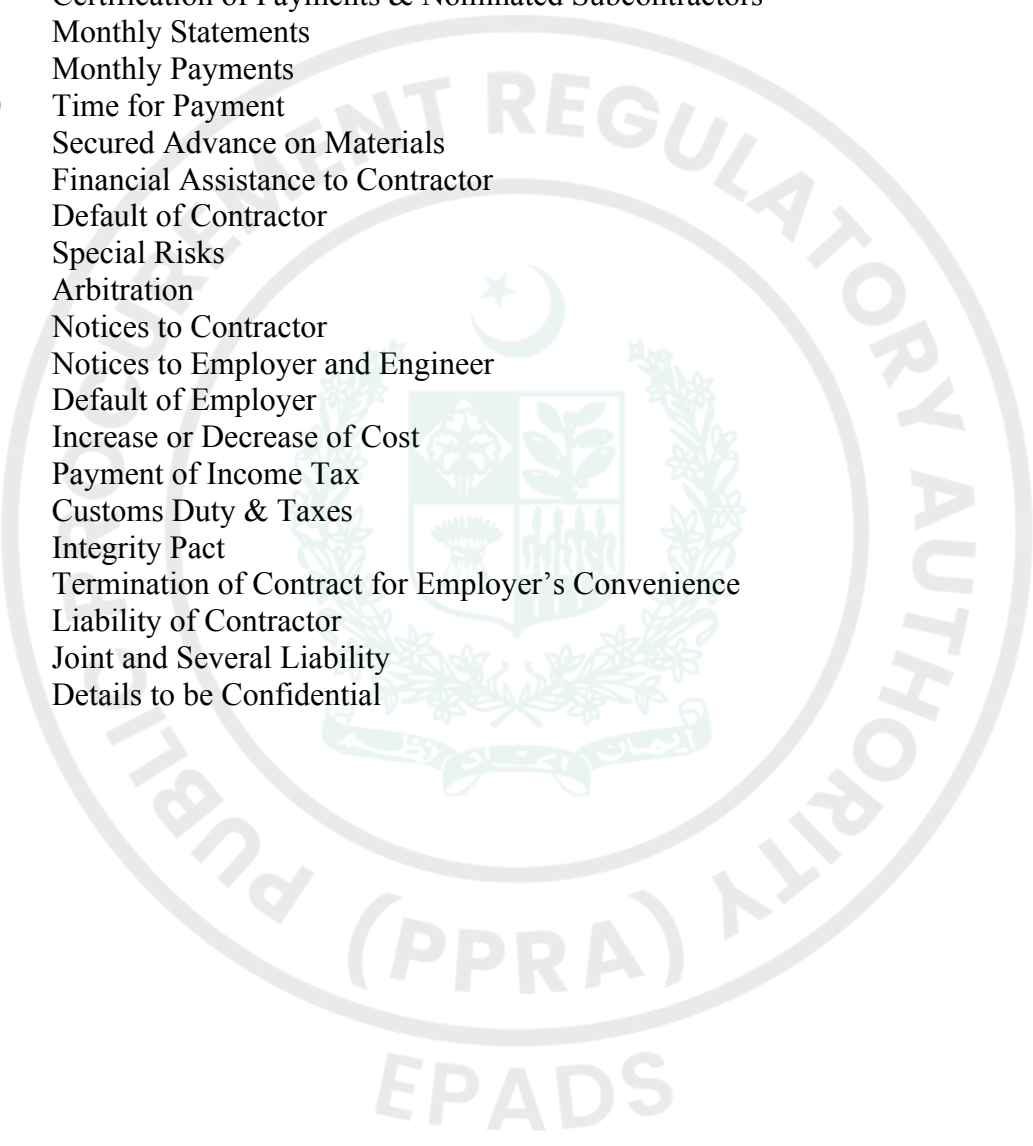

SPECIAL CONDITIONS OF CONTRACT

(Mandatory Provisions not to be Amended / Substituted except as instructed by PEC)

1.1 Definitions

- (a) (i) The Employer is: Project Director (EHV-I) NGC
NTDC House, 34-Industrial Area Gulberg-III, Lahore-Pakistan.
Telephone No. 92-42-99263225; Fax No. +92-42-99263226
E-mail address: pdehvlhr@ntdc.com.pk
- (a) (iv) The Engineer is: Executive Engineer (EHV-I) T/L'C' Division , NGC
23-Nargis Block Allama Iqbal Town, Lahore-Pakistan.
Telephone No. 92-42-35472672
E-mail address: xenehv1tlcdivisionntdclahore@gmail.com

or any other competent person appointed by the Employer, and notified to the Contractor, to act in replacement of the Engineer. Provided always that except in cases of professional misconduct, the outgoing Engineers is to formulate his certifications/recommendations in relation to all outstanding matters, disputes and claims relating to the execution of the Works during his tenure.

The following paragraph is added:

- (a)(vi) "Bidder or Tenderer" means any person or persons, company, corporation, firm or joint venture submitting a Bid or Tender.
- (b)(v) The following is added at the end of the paragraph:

The word "Tender" is synonymous with "Bid" and the word "Tender Documents" with "Bidding Documents".

The following paragraph is added:

- (b)(ix) "Programme" means the programme to be submitted by the Contractor in accordance with Sub-Clause 14.1 and any approved revisions thereto.
- (e)(i) The text is deleted and substituted with the following:

"Contract Price" means the sum stated in the Letter of Acceptance as payable to the Contractor for the execution and completion of the Works subject to such additions thereto or deductions there from as may be made and remedying of any defects therein in accordance with the provisions of the Contract.

2.1 Engineer's Duties and Authority

With reference to Sub-Clause 2.1(b), the following provisions shall also apply;

The Engineer shall obtain the specific approval of the Employer before carrying out his duties in accordance with the following Clauses:

- (i) Consenting to the sub-letting of any part of the Works under Sub-Clause 4.1 "Subcontracting".

- (ii) Certifying additional cost determined under Sub-Clause 12.2 “Not Foreseeable Physical Obstructions or Conditions”.
- (iii) Any action under Clause 10 “Performance Security” and Clauses 21,23,24 & 25 “Insurance” of sorts.
- (iv) Any action under Clause 40 “Suspension”.
- (v) Any action under Clause 44 “Extension of Time for Completion”.
- (vi) Any action under Clause 47 “Liquidated Damages for Delay” or Payment of Bonus for Early Completion of Works (PCC Sub-Clause 47.3).
- (vii) Issuance of “Taking over Certificate” under Clause 48.
- (viii) Issuing a Variation Order under Clause 51, except:
 - a) in an emergency* situation, as stated here below, or
 - b) if such variation would increase the Contract Price by less than the amount stated in the Appendix-A to Bid.
- (ix) Fixing rates or prices under Clause 52.
- (x) Extra payment as a result of Contractor’s claims under Clause 53.
- (xi) Release of Retention Money to the Contractor under Sub-Clause 60.3 “Payment of Retention Money”.
- (xii) Issuance of “Final Payment Certificate” under Sub-Clause 60.8.
- (xiii) Issuance of “Defect Liability Certificate” under Sub-Clause 62.1.
- (xiv) Any change in the ratios of Contract currency proportions and payments thereof under Clause 72 “Currency and Rate of Exchange”.

(Note: Employer may further vary according to need of the project)

* (If in the opinion of the Engineer an emergency occurs affecting the safety of life or of the Works or of adjoining property, the Engineer may, without relieving the Contractor of any of his duties and responsibilities under the Contract, instruct the Contractor to execute all such work or to do all such things as may, in the opinion of the Engineer, be necessary to abate or reduce the risk. The Contractor shall forthwith comply with any such instruction of the Engineer. The Engineer shall determine an addition to the Contract Price, in respect of such instruction, in accordance with Clause 52 and shall notify the Contractor accordingly, with a copy to the Employer.)

2.3 Engineer’s Authority to delegate:

The following paragraph is added:

The Chief Engineer (T/L Design) shall act as representative of Engineer for providing in house Engineering Services including but not limited to the following:

- a) Review & approval of technical data/ drawings/ design

- b) Interpretation of the bidding documents
- c) Review & approval of profile/ plan tabling/ route plan
- d) Foundation designs, review and approvals
- e) Site visits for attending any technical problem if necessary
- f) Resolution of disputes
- g) Review & approval of all technical matters

The following Sub-Clauses 2.7 and 2.8 are added:

2.7 Engineer Not Liable

Approval, reviews and inspection by the Engineer of any part of the Works does not relieve the Contractor from his sole responsibility and liability for the supply of materials, plant and equipment for construction of the Works and their parts in accordance with the Contract and neither the Engineer's authority to act nor any decision made by him in good faith as provided for under the Contract whether to exercise or not to exercise such authority shall give rise to any duty or responsibility of the Engineer to the Contractor, any Subcontractor, any of their representatives or employees or any other person performing any portion of the Works.

2.8 Replacement of the Engineer

If the Employer intends to replace the Engineer, the Employer shall, not less than 14 days before the intended date of replacement, give notice to the Contractor, of the name, address and relevant experience of the intended replacement Engineer. The Employer shall not replace the Engineer with a person against whom the Contractor raises reasonable objection by notice to the Employer, with supporting particulars.

5.1 Language(s) and Law

- (a) The Contract Documents shall be drawn up in the English language.
- (b) The Contract shall be subject to the Laws of Islamic Republic of Pakistan.

5.2 Priority of Contract Documents

The documents listed at (1) to (6) of the Sub-Clause are deleted and substituted with the following:

- (1) The Contract Agreement (if completed);
- (2) The Letter of Acceptance;
- (3) The completed Form of Bid;
- (4) Special Stipulations (Appendix-A to Bid);
- (5) The Special Conditions of Contract;
- (6) The General Conditions;
- (7) The priced Bill of Quantities;
- (8) The completed Appendices to Bid;
- (9) The Specifications
- (10) The Drawings;

All Drawings and Specifications shall be interpreted in conformity with the Contract and these Conditions. Addendum, if any, shall be deemed to have been incorporated at the appropriate places in the documents forming the Contract. If any ambiguity or discrepancy is found in the documents, the Engineer shall issue any necessary

clarification or instruction which shall be binding.

The Contractor shall be responsible for provision of (13) Nos. Copies of the Contract Agreement free of charge. The documents shall be arranged in the aforementioned sequence and provided to Employer within 10 days of signing of Contract Agreement.

6.1 Custody and supply of Drawings & Documents

The contractor shall supply a soft copy of such drawings in source file and any other format specified by the Engineer.

The following Sub-Clauses 6.6 and 6.7 are added:

6.6 Shop Drawings

The Contractor shall submit to the Engineer for review 3 copies of all shop and erection drawings applicable to this Contract as per provision of relevant Sub-Clause of the Contract.

Review and approval by the Engineer shall not be construed as a complete check but will indicate only that the general method of construction and detailing is satisfactory and that the Engineer's review or approval shall not relieve the Contractor of any of his responsibilities under the Contract.

6.7 As-Built Drawings

At the completion of the Works under the Contract, the Contractor shall furnish to the Engineer 6 copies and one reproducible of all drawings amended to conform to the Works as built. The price of such Drawings shall be deemed to be included in the Contract Price.

10.1 Performance Security

The text is deleted and substituted with the following:

The Contractor shall provide Performance Security to the Employer in the prescribed form. The said Security shall be furnished or caused to be furnished by the Contractor within 14 days after the receipt of the Letter of Acceptance. The Performance Security shall be of an amount equal to 10% of the Contract Price stated in the Letter of Acceptance. Such Security shall, at the option of the bidder, be in the form of bank guarantee from any Scheduled Bank in Pakistan. The cost of complying with requirements of this Sub-Clause shall be borne by the Contractor.

The following Sub-Clause 10.4 is added:

10.4 Performance Security Binding on Variations and Changes

Performance Security shall remain valid and applicable as interpreted from the conditions of Contract and amendments on account of time/scope/cost/quality variations. Further, in case of a change in Contract Price by a factor of more than 15% on account of reasons stipulated in Clause-55 of Conditions of Contract, the

Performance Security shall be liable for revision.

11.1 Inspection of Site

Bidder shall inspect the site, examine and obtain all information required and satisfy himself regarding matters and things such as access to site, communication, transport, right of way, the type and number of equipment and facilities required for the satisfactory completion of work, the quantity of various sections of the work, the availability of local labour, availability and rates of materials, local working conditions, uncertainties of weather, obstructions and hindrances that may arise etc., which may affect the work or cost thereof, before submission of his bid. Ignorance of site conditions shall not be accepted by the owner as basis for any claim for compensation. The submission of a bid by the bidder will be construed as evidence that such an examination was made and any later claims/disputes in regard to rates quoted shall not be entertained or considered by the owner.

If any temporary feeder road within site is considered essential for the proper execution of the work this shall have to be formed by the Contractor at his own cost with the prior approval of the Engineer. The Contractor shall organize his own arrangement to transport his equipment, men and materials in such a manner that the completion period will not be exceeded on any account.

The rates quoted by Bidder shall be based on his own knowledge and judgement of the conditions and hazards involved and shall not be based on any representations to the Engineer.

14.1 Programme to be submitted

The Contractor shall submit a detailed time programme to the Engineer within 28 days after receipt of Letter of Acceptance.

The Contractor shall also submit a revised programme whenever the previous programme is inconsistent with actual progress or with the Contractor's obligations.

Each programme shall be in the form of bar chart or a CPM chart identifying the critical activities and include:

- a) The order in which the Contractor intends to carry out the Works, including the anticipated timing of each stage of design (if any), Contractor's Documents, procurement, delivery to Site, construction, erection and testing.
- b) Each of these stages for work by each nominated subcontractor
- c) The sequence and timing of site inspections and tests specified in the Contract, and a supporting report which includes:
 - i) A general description of the methods which the Contractor intends to adopt, and of the major stages, in the execution of the Works, and
 - ii) Details showing the Contractor's reasonable estimate of the number of each class of Contractor's Personnel and of each type of Contractor's Equipment, required on the Site for each major stage.

Unless the Engineer, within 21 days after receiving a programme, gives notice to the Contractor stating the extent to which it does not comply with the Contract, the Contractor shall proceed in accordance with the programme, subject to his other obligations under the Contract. The Employer's Personnel shall be entitled to rely upon the programme when planning their activities.

If, at any time, the Engineer gives notice to the Contractor that a programme fails (to the extent stated) to comply with the Contract or to be consistent with actual progress and the Contractor's stated intentions, the Contractor shall submit a revised programme to the Engineer in accordance with this Sub-Clause.

The period between the Program updates will be 30 days. If the contractor fails to submit an updated program in time, any payment due for his current bills will be withheld till the submission of such programme.

14.3 Cash Flow Estimate to be submitted

The detailed Cash Flow Estimate shall be submitted within 21 days from the date of receipt of Letter of Acceptance

The following Sub-Clause 14.5 is added:

14.5 Monthly Progress Report

During the period of the Contract, the Contractor shall submit to the Engineer not later than the 8th day of the following month, copies of Monthly Progress Reports covering:

- (1) A Construction Schedule indicating the monthly progress in percentage;
- (2) Description of all work carried out since the last report;
- (3) Description of the work planned for the next 56 days sufficiently detailed to enable the Engineer to determine his programme of inspection and testing;
- (4) Monthly summary of daily job record;
- (5) Photographs to illustrate the status of progress on the Site.
- (6) Information about problems and difficulties encountered, if any, and proposals to overcome the same.
- (7) Charts and detailed descriptions of progress, including each stage of design (if any), Contractor's Documents, delivery of material to Site, construction, erection and testing; and including these stages for work by each nominated Subcontractor.
- (8) The details described in Sub-Clause 35.1 [Return of labor & Contractor's Equipment]
- (9) Copies of quality assurance documents, test results and certificates of Materials.
- (10) List of notices given under Sub-Clause 68.1[Notice to Contractor] and notices given under Sub-Clause 68.2[Notice to Employer & Engineer].
- (11) Safety statistics, including details of any hazardous incidents and activities relating to environmental aspects and public relations.
- (12) Comparisons of actual and planned progress, with details of any events or circumstances which may jeopardize the completion in accordance with the Contract, and the measures being (or to be) adopted to overcome delays.
- (13) The monthly report should also include the progress on Environmental and Social Safeguards during the last month including compensation payments,

Grievances recorded and how those responded.

These progress reports will be submitted as per the following distribution list:

- (1) CE (EHV-1), Lahore NGC
- (2) PD (PD/GSC) NGC Lahore
- (3) XEN (EHV-I) T/L 'C' DIVISION NGC Lahore

During the period of the Contract, the Contractor shall keep a daily record of the work progress, which shall be made available to the Engineer as and when requested. The daily record shall include particulars of weather conditions, number of men working, deliveries of materials, quantity, location and assignment of Contractor's equipment.

15.1 Contractor's Superintendence

The Contractor's authorised representative and his other professional engineers working at Site shall register themselves with the Pakistan Engineering Council.

The Contractor's authorised representative at Site shall be authorised to exercise adequate administrative and financial powers on behalf of the Contractor so as to achieve completion of the Works as per the Contract.

The following Sub-Clauses 15.2 is added:

15.2 Language Ability of Contractor's Representative

The Contractor's authorized representative shall be fluent in the English language. Alternately an interpreter with ability of English language shall be provided by the Contractor on full time basis.

The following Sub-Clauses 16.3 and 16.4 are added:

16.3 Language Ability of Superintending Staff of Contractor

A reasonable proportion of the Contractor's superintending staff shall have a working knowledge of the English language. If the Contractor's superintending staffs is not fluent in English language, the Contractor shall make competent interpreters available during all working hours in a number deemed sufficient by the Engineer.

16.4 Employment of Local Personnel

The Contractor is encouraged, to the extent practicable and reasonable, to employ staff and labour from sources within Pakistan.

The following Sub-Clauses 19.3 and 19.4 are added:

19.3 Safety Precautions

In order to provide for the safety, health and welfare of persons, and for prevention of damage of any kind, all operations for the purposes of or in connection with the Contract shall be carried out in compliance with the Safety Requirements of the Government of Pakistan with such modifications thereto as the Engineer may authorise or direct and the Contractor shall take or cause to be taken such further measures and comply with such further requirements as the Engineer may determine to be reasonably

necessary for such purpose.

The Contractor shall make, maintain and submit reports to the Engineer concerning safety, health and welfare of persons and damage to property, as the Engineer may from time to time prescribe.

19.4 Lighting Work at Night

In the event of work being carried out at night, the Contractor shall at his own cost, provide and maintain such good and sufficient light as will enable the work to proceed satisfactorily and without danger. The approaches to the Site and the Works where the night-work is being carried out shall be sufficiently lighted. All arrangement adopted for such lighting shall be to the satisfaction of the Engineer's Representative.

20.4 Employer's Risks

The Employer's risks are:

Notwithstanding anything contained (in GCC 20.4), the Employer shall not be responsible, compensate or bear any kind of risk/liability whatsoever in nature.

21.1 Insurance of Works and Contractor's Equipment

The minimum insurance amounts and deductibles shall be:

- (a) For the Works and Materials: Full value of material.
- (b) For loss or damage to Equipment: Full value of the loss/damage.
- (c) For loss or damage to property (except the Works, Materials, and Equipment) in connection with Contract: Full value of loss/damage to property
- (d) For personal injury or death:
 - i) of the Contractor's employees: In accordance with such applicable laws in Pakistan
 - ii) of other people: : In accordance with such applicable laws in Pakistan

21.4 Exclusions

The text is deleted and substituted with the following:

There shall be no obligation for the insurances in Sub-Clause 21.1 to include loss or damage caused by the risks listed under Sub-Clause 20.4 sub paragraph (a) to (h).

25.1 Evidence and Terms of Insurance Covers

In line-04 of paragraph-1, the words "including premium payment plan and paid premium receipts (PPRs)" are added after words "To the Employer".

Following paragraph is added at the end of existing para to form part of Clause:

"In case of failure of the Contractor to arrange insurance covers as per required terms before commencement of works, the Employer reserves right to arrange the necessary covers by itself and recover the costs from Contractor's payments including Interim Payment Certificates and Retention Monies under Clause 60."

25.4 Compliance with Policy Conditions

Delete the text and substitute with the following:

“In the event that the Contractor fails to comply with conditions imposed by the insurance policies affected pursuant to the contract, the Contractor shall indemnify the employer against all losses and claims arising from such failure.”

The following Sub-Clause 25.5 is added:

25.5 Insurance Company

The Contractor shall be obliged to place all insurances relating to the Contract (including, but not limited to, the insurances referred to in Clauses 21, 23 and 24) with either National Insurance Company of Pakistan or any other insurance company operating in Pakistan and acceptable to the Employer.

Costs of such insurances shall be borne by the Contractor.

The Contractor shall procure and submit the insurance cover before Date of Commencement. In case of failure, the contractor shall be fully responsible for any event and loss and shall indemnify as per insurance cover to be arranged. Furthermore, the Employer also reserves the right to procure the insurance policies at risk and cost of the Contractor.

The following Sub-Clause 30.5 is added:

30.5 Transport of Goods

The Contractor shall adequately record the condition of roads, agricultural land and other infrastructure prior to the start of transporting materials, goods and equipment, and construction.

The following Sub-Clause 31.3 is added:

31.3 Co-operation with other Contractors

During the execution of the Works, the Contractor shall co-operate fully with other contractors working for the Employer at and in the vicinity of the Site and also shall provide adequate precautionary facilities not to make himself a nuisance to local residents and other contractors.

The following Sub-Clauses 34.2 to 34.15 are added:

34.2 Rates of Wages and Conditions of Labour

The Contractor shall pay rates of wages and observe conditions of labour not less favourable than those established for the trade or industry where the work is carried out. In the absence of any rates of wages or conditions of labour so established, the Contractor shall pay rates of wages and observe conditions of labour which are not less favourable than the general level of wages and conditions observed by other employers whose general circumstances in the trade or in industry in which the Contractor is

engaged are similar.

34.3 Employment of Persons in the Service of Others

The Contractor shall not recruit his staff and labour from amongst the persons in the services of the Employer or the Engineer; except with the prior written consent of the Employer or the Engineer, as the case may be.

34.4 Housing for Labour

Save insofar as the Contract otherwise provides, the Contractor shall provide and maintain such housing accommodation and amenities as he may consider necessary for all his supervisory staff and labour, employed for the purposes of or in connection with the Contract including all fencing, electricity supply, sanitation, cookhouses, fire prevention, water supply and other requirements in connection with such housing accommodation or amenities. On completion of the Contract, these facilities shall be handed over to the Employer or if the Employer so desires, the temporary camps or housing provided by the Contractor shall be removed and the Site reinstated to its original condition, all to the approval of the Engineer.

34.5 Health and Safety

Due precautions shall be taken by the Contractor, and at his own cost, to ensure the health and safety of his staff and labour at all times throughout the period of the Contract. The Contractor shall further ensure that suitable arrangements are made for the prevention of epidemics and for all necessary welfare and hygiene requirements.

34.6 Epidemics

In the event of any outbreak of illness of an epidemic nature, the Contractor shall comply with and carry out such regulations, orders and requirements as may be made by the Government, or the local medical or sanitary authorities, for purpose of dealing with and overcoming the same.

34.7 Supply of Water

The Contractor shall, so far as is reasonably practicable, having regard to local conditions, provide on the Site, to the satisfaction of the Engineer or his representative, adequate supply of drinking and other water for the use of his staff and labour.

34.8 Alcoholic Liquor or Drugs

The Contractor shall not, otherwise than in accordance with the Statutes, Ordinances and Government Regulations or Orders for the time being in force, import, sell, give, barter or otherwise dispose of any alcoholic liquor or drugs, or permit or suffer any such importation, sale, gift, barter or disposal by his Subcontractors, agents, staff or labour.

34.9 Arms and Ammunition

The Contractor shall not give, or otherwise dispose of to any person or persons, any

arms or ammunition of any kind or permit or suffer the same as aforesaid.

34.10 Festivals and Religious Customs

The Contractor shall in all dealings with his staff and labour have due regard to all recognised festivals, days of rest and religious and other customs.

34.11 Disorderly Conduct

The Contractor shall at all times take all reasonable precautions to prevent any unlawful, riotous or disorderly conduct by or amongst staff and labour and for the preservation of peace and protection of persons and property in the neighbourhood of the Works against the same.

34.12 Compliance by Subcontractors

The Contractor shall be responsible for compliance by his Subcontractors of the provisions of this Clause.

35.1 Returns of Labour and Contractor's Equipment

The Contractor shall submit, to the Engineer, details showing the number of each class of Contractor's Personnel and of each type of Contractor's Equipment on the Site. Details shall be submitted each calendar month, in a form approved by the Engineer, until the Contractor has completed all work which is known to be outstanding at the completion date stated in the Taking Over Certificate for the Works.

The following Sub-Clauses 35.2 and 35.3 are added:

35.2 Records of Safety and Health

The Contractor shall maintain such records and make such reports concerning safety, health and welfare of persons and damage to property as the Engineer may from time to time prescribe.

35.3 Reporting of Accidents

The Contractor shall report to the Engineer details of any accident as soon as possible after its occurrence. In the case of any fatality or serious accident, the Contractor shall, in addition, notify the Engineer immediately by the quickest available means.

The following Sub-Clause 36.6 is added:

36.6 Use of Pakistani Materials and Services

The Contractor shall, so far as may be consistent with the Contract, make the maximum use of materials, supplies, plant and equipment indigenous to or produced or fabricated in Pakistan and services, available in Pakistan provided such materials, supplies, plant, equipment and services shall be of required standard.

41.1 Commencement of Works

The text is deleted and substituted with the following:

The Contractor shall commence the Works on Site within the period named in Appendix-A to Bid. Thereafter, the Contractor shall proceed with the Works with due expedition and without delay.

44.1 Extension of Time for Completion

The Existing Text of the provision is deleted and replaced with the following.

The Contractor shall be entitled subject to Clause 44.2 to an extension of the Time for Completion if and to the extent that completion for the purposes of Clause 43.1 & 48.2 is or will be delayed by any of the following causes:

- (a) a Variation (unless an adjustment to the Time for Completion has been agreed) or other substantial change in the quantity of an item of work included in the Contract,
- (b) a cause of delay giving an entitlement to extension of time under a Sub-Clause of these Conditions,
- (c) exceptionally adverse climatic conditions,
- (d) Unforeseeable shortages in the availability of personnel or Goods caused by epidemic or governmental actions, or
- (e) any delay, impediment or prevention caused by or attributable to the Employer, the Employer's Personnel, or the Employer's other contractors on the Site.

If the Contractor considers himself to be entitled to an extension of the Time for Completion, the Contractor shall give notice to the Engineer in accordance with Clause 44.2. The Engineer shall after due consultation with the Employer and the Contractor, determine the amount of such extension and shall notify the Employer and Contractor accordingly. The Engineer while making his determination for extension of time under this clause will take due consideration of the (committed) resources to be deployed by the Contractor at site in accordance with Appendix-E, F, G & H to bid. While determining each extension of time under this Clause, the Engineer shall review previous determinations and may increase, but shall not decrease, the total extension of time.

The Engineer shall make his determinations and notify the finalized/approved determination within reasonable time but not later than 90 days after submission of interim/final particulars by the Contractor in pursuance of this Clause as per prevalent SoPs .

46.2 Progress Reports

The Contractor shall submit to Engineer and Employer the daily, weekly, monthly progress reports and cash flow projections on the format approved by the Engineer. The monthly reports shall be submitted within 05 days from completion of the respective month.

The following Sub-Clause 47.3 is added:

47.3 Bonus for Early Completion of Works

No bonus is admissible for the project.

48.2 Taking Over of Sections or Parts

For the purposes of para (a) of this Sub-Clause, separate Times for Completion shall be

provided in the Appendix-A to Bid “Special Stipulations”.

49.2 Completion of Outstanding Works and Remedying Defects

The following sub-clause is included at end of existing text

- c) Provide detailed Completion Report alongwith As built data/drawings, material reconciliation reports and Hard and Soft Copies of site records/data to the Engineer for information and approval prior to expiry of Defect Liability Period. One copy shall also be provided to Employer for reference.
- d) Return balance/surplus materials to designated NGC warehouses as per material re-conciliation reports dully approved by the Engineer. All Coordination in allocation and handing over of material will be carried out through Engineer of the Project.

The following Sub-Clause 49.5 is added:

49.5 Extensions of Defects Liability Period

The provisions of this Sub-Clause shall apply to all replacements or renewals of plant and equipment carried out by the Contractor to remedy defects and damage as if the replacements and renewals had been taken over on the date they were completed. The Defects Liability Period for the Works shall be extended by a period equal to the period during which the Works cannot be used by reason of a defect or damage. If only a part of the Works is affected the Defects Liability Period shall be extended only for that part. In neither case shall the Defects Liability Period extend beyond two (2) years from the date of taking over.

51.1 Variations

The Sub-Clause (a), (b), (c), (d), (e) & (f) are deleted and replaced with following text

- (a) changes to the quantities of any item of work included in the Contract (however, such changes do not necessarily constitute a Variation if and to the extent that change is due to Clause 55.1 and 56.1),
- (b) changes to the quality and other characteristics of any item of work,
- (c) changes to the levels, positions and/or dimensions of any part of the Works,
- (d) omission of any work unless it is to be carried out by others,
- (e) any additional work, Plant, Materials or services necessary for the Permanent Works, including any associated Tests on Completion, boreholes and other testing and exploratory work, or
- (f) Changes to the sequence or timing of the execution of the Works.

51.2 Instructions for Variations

At the end of the first sentence, after the word “Engineer”, the words “in writing” are added.

52.1 Valuation of Variations

In the tenth line, after the words “Engineer shall” the following is added:

Within a period not exceeding one-eighth of the completion time subject to a minimum of 56 days from the date of disagreement whichever is later.

53.4 Failure to Comply

This Sub-Clause is deleted in its entirety.

54.5 Conditions of Hire of Contractor’s Equipment

The following paragraph is added:

The Contractor shall, upon request by the Engineer at any time in relation to any item of hired Contractor’s Equipment, forthwith notify the Engineer in writing the name and address of the Owner of the equipment and shall certify that the agreement for the hire thereof contains a provision in accordance with the requirements set forth above.

The following Sub-Clauses 59.4 & 59.5 are added:

59.4 Payments to Nominated Subcontractors

The Contractor shall pay to the nominated Subcontractor the amounts which the Engineer certifies to be due in accordance with the subcontract. These amounts plus other charges shall be included in the Contract Price in accordance with Clause 58 [Provisional Sums], except as stated in Sub-Clause 59.5 [Certification of Payments].

59.5 Certification of Payments & Nominated Subcontractors

Before issuing a Payment Certificate which includes an amount payable to a nominated Subcontractor, the Engineer may request the Contractor to supply reasonable evidence that the nominated Subcontractor has received all amounts due in accordance with previous Payment Certificates, less applicable deductions for retention or otherwise. Unless the Contractor:

- a) submits reasonable evidence to the Engineer, or
- b)
 - i) satisfies the Engineer in writing that the Contractor is reasonably entitled to withhold or refuse to pay these amounts, and
 - ii) submits to the Engineer reasonable evidence that the nominated Subcontractor has been notified of the Contractor’s entitlement,

Then the Employer may (at his sole discretion) pay direct to the nominated Subcontractor, part or all of such amounts previously certified (less applicable deductions) as are due to the nominated Subcontractor and for which the Contractor has failed to submit the evidence described in sub-paragraphs (a) or (b) above. The Contractor shall then repay, to the Employer, the amount which the nominated Subcontractor was directly paid by the Employer.

60.1 Monthly Statements

In the first line after the word “shall”, the following is added:

“on the basis of the joint measurement of work done under Clause 56.1,”

In Para (c) the words “the Appendix to Tender” are deleted and substituted with the words “Sub-Cause 60.11 (a)(6) hereof”.

(in case Clause 60.11 is applicable)

The Last Paragraph starting from word “Notwithstanding” and ending with word “Employer” is deleted

60.2 Monthly Payments

In the first line, “28” is substituted by “14”.

60.3 Payment of Retention Money

a) The following text is added at the end:

“In addition to above, release of this retention money is subject to issuance of GRN/SRS by In charge of designated NGC Warehouse for balance material ,if any, of the project as per material reconciliation report along with certification from In charge of the Ware House of completeness and healthiness of the returned material.

60.10 Time for Payment

No interest is applicable on any delay at the part of the employer. Second Para starting from “In the event of failure” and ending on “under clause 69 otherwise” is deleted.

The following Sub-Clause 60.11, 60.12 & 60.13 are added:

60.11 Secured Advance on Materials (Not Applicable)

Deleted

60.12 Financial Assistance to Contractor (Not Applicable)

Deleted

60.13 Employer’s/Engineer’s Right to withhold payments

- a) Notwithstanding the terms of Clause 60.2 & 60.3 or any other Clause of the Contract, no amount will be certified by the Engineer for payment/paid by Employer until the Performance Security/Advance Payment Security, if required under the Contract, has been provided by the Contractor, approved by the Employer and is valid for the required duration stated in the Contract Clause 10.2 and 60.12.
- b) In case of Contractor’s non-compliance with reporting requirements under Clause-46.2 and insurance requirements under Clause 20 of Conditions of Contract.
- c) If there is any ambiguity in the payment/claim or Interim Payment Certificate, the Employer may withheld the payment to such extent and may process the remaining amount. In such case, the withheld amount may be included in the next Payment Certificate alongwith clarification for ambiguity pointed out by Employer.
- d) In case of Contractor’s non-compliance with the laws/regulations of the tax authorities’ (Federal/Provincial), the Employer reserves the right to withhold the payments for ensuring the necessary compliance.

63.1 Default of Contractor

The following para is added at the end of the Sub-Clause:

Provided further that in addition to the action taken by the Employer against the Contractor under this Clause, the Employer may also refer the case of default of the Contractor to Pakistan Engineering Council for punitive action under the Construction and Operation of Engineering Works Bye-Laws 1987, as amended from time to time.

65.2 Special Risks

The text is deleted and substituted with the following:

The Special Risks are the risks defined under Sub-Clause 20.4 sub paragraph (a) to (h).

67.3 Arbitration

In the sixth to eight lines, the words “shall be finally settled appointed under such Rules” are deleted and substituted with the following:

shall be finally settled under the provisions of the Arbitration Act, 1940 as amended or any statutory modification or re-enactment thereof for the time being in force.

The following paragraph is added:

The place of arbitration shall be Lahore, Pakistan.

68.1 Notices to Contractor

The following paragraph is added:

For the purposes of this Sub-Clause, the Contractor shall, immediately after receipt of Letter of Acceptance, intimate in writing to the Employer and the Engineer by registered post, the address of his principal place of business or any change in such address during the period of the Contract.

68.2 Notices to Employer and Engineer

For the purposes of this Sub-Clause, the respective addresses are:

- a) The Employer: Project Director (EHV-I) NGC
NTDC House, 34-Industrial Area Gulberg-III, Lahore-Pakistan.
Telephone No. 92-42-99263225; Fax No. +92-42-99263226
E-mail address: pdehvlhr@ntdc.com.pk
- b) The Engineer: Executive Engineer (EHV-I) T/L’C’ Division , NGC
23-Nargis Block Allama Iqbal Town, Lahore-Pakistan.
Telephone No. 92-42-35472672
E-mail address: xenehv1tcldivisionntdclahore@gmail.com

69.0 Default of Employer

This clause with all sub clauses is deleted in its entirety.

70.1 Increase or Decrease of Cost (Not Applicable)

Sub-Clause 70.1 is deleted in its entirety.

The following Sub-Clauses 73.1, 73.2, 74.1, 75.1, 76.1, 77.1 and 78.1 are added:

73.1 Payment of Income Tax

The Contractor, Subcontractors and their employees shall be responsible for payment of all their income tax, super tax and other taxes on income arising out of the Contract and the rates and prices stated in the Contract shall be deemed to cover all such taxes.

73.2 Customs Duty & Taxes

Provincial Sales Tax

Contractor will submit the invoice inclusive of Provincial Sales Tax. Provincial Sales Tax shall be charged by the contractor and payments will be subject to income tax and sales tax withholding as per Rules mentioned in Federal or Respective Provincial Laws only to those entities appearing in Active Taxpayer list (ATL) for both income and Sales Tax. Copy of sales tax return will be provided by the contractor. In case of non-registration with the relevant provincial authority, the tax will be deducted from the amount due or to be due to the contractor.

74.1 Integrity Pact

If the Contractor or any of his Subcontractors, agents or servants is found to have violated or involved in violation of the Integrity Pact signed by the Contractor as Appendix-O to his Bid, then the Employer shall be entitled to:

- (a) recover from the Contractor an amount equivalent to ten times the sum of any commission, gratification, bribe, finder's fee or kickback given by the Contractor or any of his Subcontractors, agents or servants;
- (b) terminate the Contract; and
- (c) recover from the Contractor any loss or damage to the Employer as a result of such termination or of any other corrupt business practices of the Contractor or any of his Subcontractors, agents or servants.

The termination under Sub-Para (b) of this Sub-Clause shall proceed in the manner prescribed under Sub-Clauses 63.1 to 63.4 and the payment under Sub-Clause 63.3 shall be made after having deducted the amounts due to the Employer under Sub-Para (a) and (c) of this Sub-Clause.

75.1 Termination of Contract for Employer's Convenience

The Employer shall be entitled to terminate the Contract at any time for the Employer's convenience after giving 56 days prior notice to the Contractor, with a copy to the Engineer. In the event of such termination, the Contractor:

- (a) shall proceed as provided in Sub-Clause 65.7 hereof; and
- (b) shall be paid by the Employer as provided in Sub-Clause 65.8 hereof.

76.1 Liability of Contractor

The Contractor or his Subcontractors or assigns shall follow strictly, all relevant labour laws including the Workmen's Compensation Act and the Employer shall be fully indemnified for all claims, damages etc. arising out of any dispute between the Contractor, his Subcontractors or assigns and the labour employed by them.

77.1 Joint and Several Liabilities

If the Contractor is a joint venture of two or more persons, all such persons shall be jointly and severally bound to the Employer for the fulfilment of the terms of the Contract and shall designate one of such persons to act as leader with authority to bind the joint venture. The composition or the constitution of the joint venture shall not be altered without the prior consent of the Employer.

78.1 Details to be Confidential

The Contractor shall treat the details of the Contract as private and confidential, save in so far as may be necessary for the purposes thereof, and shall not publish or disclose the same or any particulars thereof in any trade or technical paper or elsewhere without the prior consent in writing of the Employer or the Engineer. If any dispute arises as to the necessity of any publication or disclosure for the purpose of the Contract, the same shall be referred to the decision of the Engineer whose award shall be final.

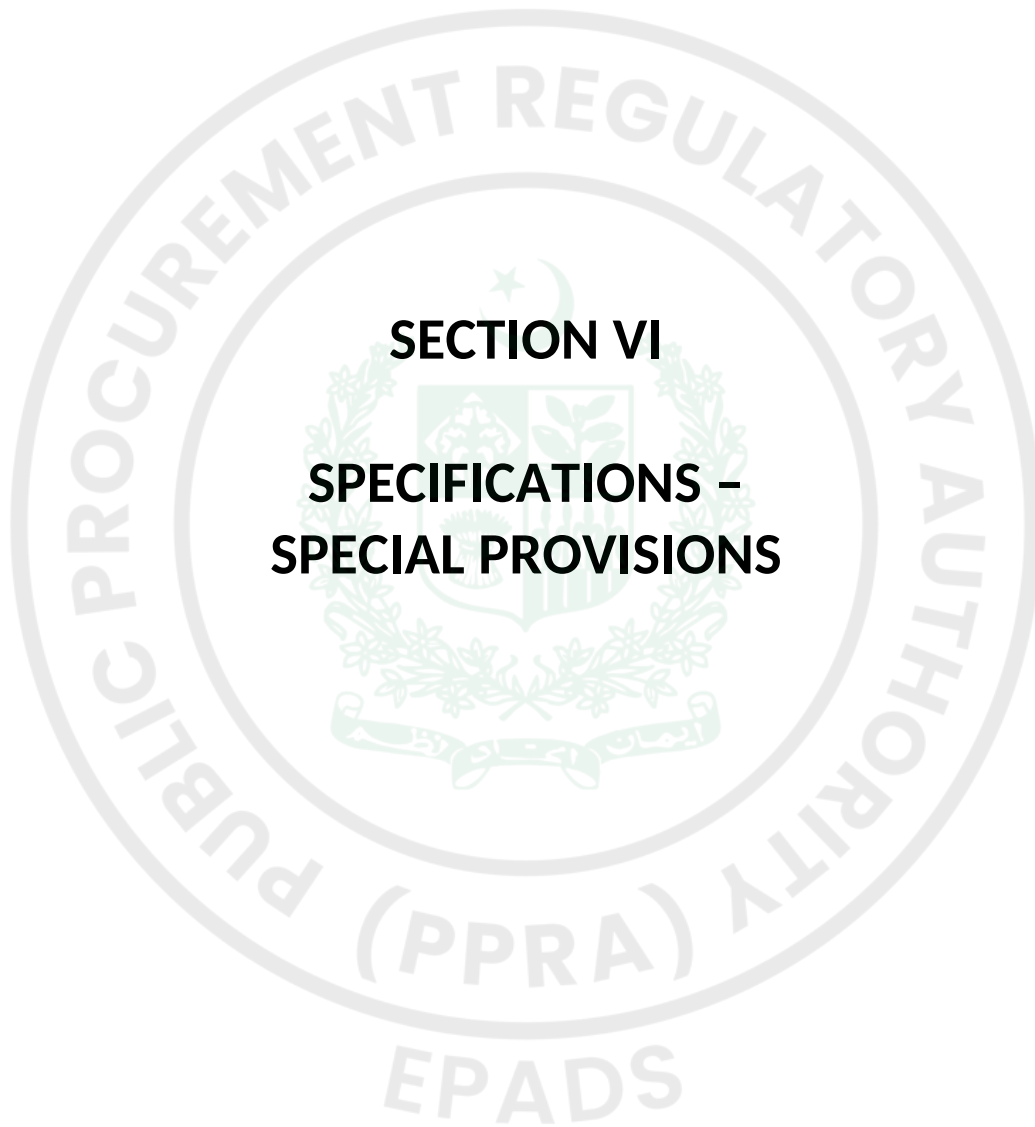

SECTION VI
SPECIFICATIONS –
SPECIAL PROVISIONS

SECTION VI SPECIFICATIONS - SPECIAL PROVISIONS

SP-01 ACQUAINTANCE WITH SITE

The Contractor shall be deemed to have inspected and examined the Site and its surroundings and information available in connection therewith and before submitting his Bid, as to the form and nature thereof, including the subsurface conditions, the hydrological and climatic conditions, the extent and nature of Works for completion, the means of access to the Site and the accommodation he may require and, in general, shall be deemed to have obtained all necessary information, subject as above mentioned, as to risks, contingencies and all other circumstances which may influence or affect his Contract.

SP-02 DESCRIPTION OF PROJECT

220kV Sheikhpura-Ravi Transmission Line is constructed from 500kV grid Station Sheikhpura to 220kV Grid Station Ravi for dispersal of the power generated as well as interconnection in between national grids. This project is Conversion of Tower Nos. 42 & 43 of 220kV D/C T/B T/line from Suspension Type to Tension Type to be constructed through NGC's own resources in accordance with the Bidding Documents.

The Line is of Twin Bundle ACSR "Rail" conductor per phase having an OPGW on the tower peaks.

Plan and profile for rehabilitation work has already been approved and shall be shared with contractor after award of contract.

SP-02.1 Location of Project

Near Motorway Interchange Kot pindi Das (District Sheikhpura).

SP-04 WORKS

SP-04.1 Works

The intent of these Specifications is that the Works under this Contract should be equal to or superior than those actually described herein. In choosing indigenous materials and their finishes due regard shall be given to the conditions prevailing at Site.

SP-04.2 Extent of Specifications

The extent of the Bidding Documents is to provide for the Works herein specified to be fully complete in every detail for the function designated. All Works which are not specifically mentioned in the Bidding Documents, but which, in the opinion of the Engineer, are usual or necessary for the satisfactory completion of the Works shall be deemed to be included in the Contract Documents and shall be provided by the Contractor without extra cost to Employer.

SP-05 WORKS BY CONTRACTOR

SP-05.1 Scope

The scope of Works includes but not limited to insurance, loading at Employer's designated Storage Yard, transportation, unloading of material provided by the Employer i.e. steel towers including stubs angles for foundations, conductor and OPGW along with associated equipment, conductor & OPGW accessories and dampers, disc insulators along with associated hardware, grounding materials, delivering to site and storing thereof, its installation and all other Works required to Construction and Completion of Civil Works, Erection, Stringing, Testing & Commissioning for Conversion of Tower Nos. 42 & 43 of 220kV D/C T/B T/line from Suspension Type to Tension Type.

The Works to be performed under these Specifications are based on the rates provided in the Bill of Quantities and include but not limited to the following:

- i. Provision of all guarantees, insurances, field offices/camps, storage camps, labour, services, Plant and Contractor's tools and equipment (including tension stringing and construction equipment) to construct, complete, test and commission the said transmission line in accordance with the requirements of the Contract Documents.
- ii. Prepare and furnish all drawings and documents.
- iii. Provision of access roads where necessary.
- iv. Dismantling of existing towers and conductor along with accessories
- v. Clearing right-of-way including disposal of cleared materials.
- vi. Check Survey including pegging out and layout of tower locations, spotting / staking of towers, tower spotting adjustment etc.
- vii. Establishing route alignment of any diversion required and detailed survey not limited to chainage & leveling.
- viii. Sub-soil investigation along the line including laboratory tests and preparation & submission of sub-soil investigation reports along with design & recommendation for type of foundation of any diversion required.
- ix. Preparation of plan & profile drawings (only diverted portion), tower spotting etc.
- x. Preparation of construction structure lists, sag-tension charts for conductor & OPGW stringing and construction drawings.
- xi. Surveying of tower sites, tower staking, tower spotting adjustment and establishing correct locations of footings.
- xii. Excavation, formation of ramps, grading, blasting, leveling, cutting and backfilling including disposal of surplus/excavated material.
- xiii. Furnishing materials for constructing reinforced concrete tower foundations including installation of steel stub angles and tower grounding.
- xiv. Ground assembly of tower sections and erection of steel towers.
- xv. Installing insulator assemblies for conductors.
- xvi. Stringing conductors, overhead shield wire and OPGW complete with hardware, accessories and dampers.
- xvii. Furnishing and installing tower signs (Aerial Markers, Danger Signs, Number and Phase Plates etc.), and anti-climbing devices.
- xviii. Latitude and Longitude by hand held GPS of each tower location.
- xix. Testing and commissioning of the aforesaid Transmission Line.

- xx. The security arrangements to be provided by the Contractor for his own crews/staff/storage yards.
- xxi. Preparation & submission of monthly progress reports including site photographs, as-built data and drawings including copies on reproducible transparencies and USB using AutoCAD.
- xxii. Any other item which is not included here but is necessary for integrated operation of Transmission Line as advised by the Engineer.
- xxiii. Making all necessary arrangements free of cost to access to tower locations on dry patches/land engulfed in river creeks.
- xxiv. Welding of bolts and Painting of tower stub/tower member/plates/bolts or repair of already painted tower as advised by the Engineer.
- xxv. Preparation of complete as built profile by the contractor. As built profile shall be vetted by Project Manager/ Consultant and will be submitted to the Chief Engineer (T/L Design) NGC.
- xxvi. Preparation of Material Reconciliation Report as per as-built profile.
- xxvii. Any other activity specifically not covered in the scope of work but is required for the completion, testing & commissioning and operation of the overhead line shall be deemed to be included in the scope of work.

NOTE:

- (1) The Contractor is responsible to mobilize sufficient numbers of crews for foundations, tower erection and stringing etc. equipped with T&P complete in all respects for smooth execution of each activity. For timely completion of the Project, Contractor is responsible to adhere to the project schedule and ensure that the sufficient resources are available with the crews before commencement of each activity. Detailed methodology and list of T&P shall have to be got approved from the Engineer well before the commencement of each activity. The detail of construction equipment/T&P to be arranged/imported from abroad by the Contractor must be furnished in his Bid.
- (2) In case Contractor fails to arrange the required numbers of crews along with requisite T&P in good working condition for inspection at site prior to commencement of respective activity, Employer has the right, in addition to withhold current payments, terminate the Contract at any stage and to get executed the balance work through other Contractors at the Contractor's risk and cost.

SP-06 DRAWINGS

SP-06.1 Drawings in Contract

SP-06.1.1 Specification Drawings

The specification drawings contained in Volume II of the Contract Documents show the Specifications and Scope of Works to be performed by the Contractor.

SP-06.1.2 Contractor's Bid Drawings

The Contractor's bid drawings are the drawings prepared by the Contractor for bidding purposes, and shall be part of his Bid.

The specification drawings and Contractor's bid drawings shall not be used for execution of the Works unless specific instructions for such use are given by the Engineer.

SP-06.1.3 **Approved Drawings**

The Works shall be performed in accordance with the approved drawings.

SP-06.2 **Drawings and Other Data to be furnished by the Contractor**

All drawings shall be in English language and all dimensions shall be in Metric System. Symbols shall be in accordance with IEC standards. All drawings shall be clearly marked "National Grid Company (NGC) of Pakistan Limited for Construction and Completion of Civil Works, Erection, Stringing, Testing & Commissioning for Conversion of Tower Nos. 42 & 43 of 220kV D/C T/B T/line from Suspension Type to Tension Type. All drawings/ data submitted for approval shall conform to ISO paper sizes A0 to A4.

The Contractor shall submit detailed drawings as required herein below:

- (i) Plan & profile drawings (only diverted portion) showing spotted towers, construction structure list, sag-tension charts for conductor & OPGW stringing, soil investigation reports and other data as required by the Engineer.
- (ii) Bar bending schedule for various types of foundations/piles.
- (iii) Drawings indicating crossings of transmission line over Railway tracks and Highways.
- (iv) Specifications and details of concrete mix ratio and aggregate grading.
- (v) Sag-templates for tower spotting.
- (vi) Any other information and drawing which may be required for construction purposes.

SP-06.3 **Distribution of Drawings**

The drawings shall be submitted to the Engineer/Employer within the time given in the Contract or within such reasonable time as the Engineer may require, and in the number as specified hereunder:

Documents	Engineer		Employer/ Project Director	Total
	Head Office	Site Office		
Drawings for approval	3	-	1	4
Approved Drawings	2	2	1	5

Schedules, specifications and other documents/data	2	1	1	4
Construction Drawings	2	6	2	10
Soil Investigation Reports	3	-	1	4
Record (As-Built) Drawings	2	-	4	6
Reproducible transparency Record (As-Built) Drawings	1	-	1	2
Record (As-Built) Drawings on computer compact diskette (CD/DVD) using AutoCAD Software	1	-	1	2
Insurance Certificates	1	1	2	4
Receiving reports	1	1	2	4
Damage reports	1	1	2	4
Erection progress Reports	2	1	2	5
List of Construction Stringing and Erection Equipment	1	1	1	3
Correspondence with Employer	1	1	1	3
Correspondence with Head office of Engineer	1	1	1	3
Correspondence with Site office of Engineer	1	1	1	3

SP-06.3.1 Record Drawings

In the event of the Works or any part thereof being, with the approval of the Engineer, properly built-in or installed otherwise than in accordance with the Approved Drawings, then the Contractor shall ensure that the Approved Drawings are marked up to show the conditions of the Works as installed and at least two (2) copies of such marked up drawings shall be submitted by the Contractor to the Engineer for approval. One copy of each of marked -up drawings approved by the Engineer shall be returned to the Contractor by the Engineer and these shall be used for the preparation of the Record Drawings within sixty (60) days after the completion of Works of the line. A further copy of each of the marked-up drawings shall be retained by the Engineer for the purpose of checking the Record Drawings.

The Contractor shall furnish to the Engineer two (2) complete sets of all Record Drawings and Data prior to issuance of the Operational Acceptance Certificate. The Contractor shall also furnish to the Engineer one (1) mylar

polyester base full-size reproducible and one copy on a computer compact diskette (CD/DVD) using AutoCAD, of all final Records and other drawings which, in the opinion of the Engineer, may be required for the Works operation and maintenance, for identification of parts and for ordering replacement parts and materials. The mylar reproducible shall be 50/70 microns thick, double matte film, washed off the film, and printed on front.

SP-07 INSURANCE OF MATERIALS FURNISHED BY NGC

The Contractor shall maintain and pay for insurance for Materials furnished by NGC, against loss or damage of the Material caused by, or resulting from but not limited to the following:

- (1) Fire, smoke, explosion, falling objects, impacts by aircrafts or land vehicles, lightning, riot, the escape of water, flood, Act of God, land sliding, vandalism or malicious mischief, windstorm, rain or hailstorm, and
- (2) Theft or attempted theft:

for the full assessed value of the Materials. The insurance shall commence and shall be in force no later than the time of receipt from NGC's stores where the Contractor is required to obtain the Materials. This insurance must remain in force until the contractor clears and finalizes all accounts of Materials furnished by NGC and the Material is returned to NGC. Certificates of such insurance and all renewals thereof shall be filed with the Engineer. Insurance cover shall be obtained from an insurance company approved by NGC.

The Contractor shall be responsible for the safety and protection of Materials from the point where and at the specified time when he is required to obtain the Materials until the Material is returned to NGC. Should a loss be sustained, the Contractor shall replace or repair any loss or damage and complete the Works in accordance with the Contract on a priority basis after such loss or damage without waiting for the settlement of the insurance claim.

SP-08 HANDLING, LOADING AND UNLOADING OF EQUIPMENT & MATERIAL

SP-8.1 Lifting

The method of lifting, type of equipment and type of slings, used for handling the conductor reels are subject to approval by the Engineer. The wooden reels are so constructed as to be supported either on an axle through the arbor hole or by the reel flange. When the reels are lifted by an axle supported from above, a spreader bar must be employed to prevent reel damage by inward pressure on reel flange. In no case shall metallic slings or other metallic equipment shall come in contact with conductor or overhead shield wire or ground wire.

SP-8.2 Slings

If the use of slings is necessary, these shall be of a flexible type and preferably manila rope or other non-metallic materials. The use of steel wire, mesh or

chain link slings is prohibited unless they are covered with rubber hose or some similar material.

SP-8.3 Unloading and Storage at the Site

- (1) The Contractor shall unload all Plant and other material at the Site. Items for permanent installations shall be properly stored and shall be protected as required to prevent damage or deterioration of any type. Storage/ Stacking methods shall be such as to cause minimum inconvenience to others and shall be arranged to facilitate inspection.
- (2) All Plant and other material storage shall comply with the requirements of the Specifications or to the approval of the Engineer.

SP-8.4 Ownership of Packing Materials

All packing boxes, reels, and shipping containers except those containers which are not the property of the Contractor, planking covers, etc. shall become the property of the Employer. All the packing materials shall be handed over to the Employer immediately after storage requirements of the Plant or parts including spares thereof and other materials are over.

SP-9 SCHEDULE, PROGRESS REPORTS AND MEETINGS

SP-9.1 Schedule

The Contractor shall carry out the Works in accordance with the dates/periods specified in Appendix-A to Bid. The Contractor shall regularly review the Schedule and notify the Engineer promptly of any revisions which in his view may be required from time to time.

SP-9.1.1 Form of Construction Schedule

The Schedule shall be a detailed CPM (critical path method) type, time scaled according to calendar dates and Project month numbers. The CPM for planning, scheduling, and controlling will be used for the Contract. The Contractor shall submit a schedule showing the logical sequence in which the Plant will be carried out in sufficient detail to satisfy the Engineer that the Plant is thoroughly planned and meets all the requirements of the Contract Documents.

SP-9.2 Progress Meetings

- (1) Soon after the date of signing of the Contract, the Engineer will, with the approval of the Employer require a conference with the Employer and the Contractor at a place mutually agreed upon, to discuss progress monitoring and proper execution of the Contract.
- (2) At monthly intervals or from time to time during the execution of the Contract, the Engineer may call meetings, either in his offices or at the Contractor's offices or Employer's office as is deemed necessary for the purpose of progress monitoring and proper execution of the Contract.

- (3) As required by the Engineer, responsible representatives of the Contractor shall attend such meetings.
- (4) All expenses incurred by the Contractor for attending such meetings shall be borne by the Contractor and shall not be reimbursable.

SP-10 SITE WORKS

Attention is drawn to the obligations of the Contractor to make his own arrangements at his own expense for Works provided to his employees. Any cost incurred by the Contractor in respect of any of such Site Works under the Contract shall be deemed to be included in the rates and prices in the Price Schedules and no separate payment, therefore, will be made to the Contractor.

SP-10.1 Accommodation

- (1) The Contractor shall provide and maintain at his cost residential accommodation and transportation Works for his own use.
- (2) The Contractor shall provide and maintain such housing accommodation and amenities as he may consider necessary for all of his supervisory staff and labour employed for the purposes of or in connection with this Contract including all fencing, electricity supply, sanitation, cook, houses, fire prevention, water supply and other requirements in connection with such housing accommodation or amenities.

SP-10.2 Offices

The Contractor shall arrange and maintain his offices at his own cost.

SP-10.3 Work-yards and Storage Areas

- (1) No storage site shall be provided by Employer to store Plant and other material. The Contractor shall, furnish all the necessary services and be responsible for the construction and maintenance of the necessary construction camps, offices and stores; and perform all other work necessary for completion of the Works described herein in strict conformance with these Specifications.
- (2) The Contractor shall provide his own watchman service to ensure security and safety of the Plant and other material prior to Employer taking over the Works.

SP-10.4 Temporary Buildings

- (1) The Contractor shall provide and maintain all temporary structures required including warehouses, change houses for workmen, sheds, etc. He shall also provide his own field office complete with telephone so that he or his official representative can be contacted by Employer and/or Engineer at all times.
- (2) Such temporary buildings and/or utilities shall remain the property of the Contractor and shall be removed by him at his expense upon the completion of the Works and the Site reinstated to its original condition, all to the approval of the Engineer.

SP-11 QUALITY CONTROL

The Contractor's Quality Control Department shall review all contract and specification requirements and ensure that they are understood.

Upon the award of the Contract, the Contractor, NGC and the Engineer shall establish mutually acceptable quality control and inspection procedures between the Contractor and the Engineer and indications are to be given at that time by Contractor as to how the agreed procedures will be implemented.

All Works covered by the Contract and the inspection thereof by the Contractor, shall be subject to surveillance and/or further inspection by NGC and/or the Engineer or by their authorized representative for which purpose the Contractor (or Sub-Contractor) shall:

- (1) Demonstrate to the satisfaction of the Engineer or his authorized Representative that the Works meets the requirements of the Contract.
- (2) Not cover up or put out of view Works until the Engineer or his authorized representative has been notified and release of Works has been obtained.
- (3) Afford full opportunity for the Engineer or the Engineer's Representative to examine and measure any work which is about to be covered up or put out of view and to examine foundations before permanent work is placed thereon.
- (4) Give due notice to the Engineer's Representative whenever any Work or foundations is/are ready or about to be ready for Examination.

SP-12 URGENT REPAIRS

If by reason of any accident or failure or other event occurring to in or in connection with the Work or any part thereof either during the execution of the Work or during the Period of Guarantee any remedial or other Work or repair shall in the opinion of the Engineer or the Engineer' Representative be urgently necessary for security and the Contractor is unable or unwilling at once to do such Work or repair, NGC may employ its own or other workmen do such work or repair as the Engineer or the Engineer's representative may consider necessary. If the Work or repair so done by NGC is Work which in the opinion of the Engineer the Contractor was liable to do at his own expense under the Contract all costs and charges properly incurred by NGC in so doing shall on demand be paid by the Contractor to NGC or may be deducted by NGC from any money due or which may become due to the Contractor.

SP-13 MEASUREMENT FOR PAYMENT

The measurement for payment and payment for the various items of Price Schedules shall be as follows:

- (a) **Construct Right-of-Way Road**

No payment will be made for the construction of a right-of-way road and access routes. The cost of such road and access routes, if constructed, shall be deemed to be included in other prices in the Contract.

Employer will assess the compensation for unavoidable crop damage that occurs on the right of way in cultivated areas and will pay the compensation amount.

(b) **Clearing Right-of-Way**

Measurement for payment will be made horizontally along the center line of right-of-way cleared and disposal completed.

Payment will be made based on the unit price quoted in Price Schedules. The payment shall include, but not be limited to the brushing out the centerline, tower locations and conductor pulling sites within 25 meters on each side of the centerline. Trees over 2.5 meters in height which constitute a hazard or danger to the transmission line, or whose tops are within 6 meters of the 75°C final conductor position shall be removed.

(c) **Check Survey**

Measurement for payment will be made on the check survey carried out as per given Technical Provisions.

Payment will be made based on lump sum basis after fulfilling all requirements given in Technical Provisions.

(d) **Survey (Only for diverted portion)**

Measurement for payment will be made horizontally along the center line of the line route.

Payment will be made based on the unit price quoted in the Price Schedules after the approval by Engineer of detailed survey, plan and profile drawings, and construction structure list. The unit price shall include but not be limited to the route establishing, detailed survey, route maps, plan tabling, profile preparation, tower spotting, construction structure list and all other work necessary for the completion of this phase of work.

(e) **Sub Soil Investigation (Drilling Boreholes, SPT and undisturbed sampling) (Only for diverted portion)**

Measurement for drilling and testing shall be made for actual length of boreholes drilled including SPT tests performed of diverted portion only with the approval of the Engineer and actual excavated depth for test pits.

Payment shall be based in accordance with the unit price quoted in the Price Schedules. All the necessary operations done to accomplish drilling and testing as specified shall be deemed to be part of this item and no extra payment for such operation shall be made. The cost of standard penetration tests, rock coring, undisturbed sampling and block sampling (in case of test pits) is included in the cost of Sub Soil Investigations and includes but not limited to all costs and expenses for records, operations, samples, preservation,

and transportation to the laboratory of the selected disturbed/ undisturbed samples taken from the SPT Spoon.

(f) **Laboratory Tests**

No Payment shall be made for any laboratory test performed. The unit price given for sub-soil investigations shall be deemed to include complete laboratory testing for the specified tests according to the ASTM Standards and compilation and presentation of reports including foundation design/designation in standard form as approved by the Engineer.

(g) **Reinforced Concrete Foundations**

Measurement for payment will be made for each type of foundation installed as shown on the approved relevant construction drawings for the various foundations. Bid drawings for concrete foundations provided in the Specification Drawings are firm & final and no change is acceptable except from Engineer.

The quoted unit price shall include, but not be limited to tower staking, site contouring, the cost of furnishing all labour, equipment, materials (including concrete and reinforcement etc.) site leveling, blasting/cutting/grading of tower site, excavation, shuttering, dewatering, shorting, forming, reinforcing, concreting, curing, backfilling, installing stub angles, tower grounding, setting and all other associated Works to produce finished foundations.

(h) **Installing Piles/ Pile Cap/ Tie Beam**

Measurement under this item shall be made at actual number of the foundations constructed and actual length of each pile, pile cap and tie beam installed as shown on the Bid Drawings and according to the Specifications. Bid drawings are firm & final and no change is acceptable except from Engineer. In such case rates will be derived from the similar works.

Payment shall be made in accordance with the unit price quoted in the Price Schedules. Such unit price shall constitute full compensation for pile foundation construction based on measurement described above. Such payment shall be deemed to include access roads, temporary bridges, the cost of tower staking, making bore holes, cost of materials (including concrete and reinforcement etc.), ramp, placement and curing of concrete, backfilling, installing stub angles, tower grounding and all other arrangements required to complete the pile foundation to the satisfaction of the Engineer.

(i) **Steel Tower Erection**

Measurement for payment will be made for each type of component installed as shown on the relevant drawings for the various towers.

Payment will be made based on the unit prices quoted in the bid for each type of component installed of all tower types. The unit prices shall include, but not be limited to, detailing of tower fabrication drawings supplied by the Employer, the cost of all labour, equipment, requisitioning, loading, transporting, from site storage areas to the sites, erecting together with bolts,

nuts, washers, step bolts, including back bolting and punching of nuts and bolts and all other associated work necessary for the completion of the towers ready for installation of overhead OPGW and conductors thereon.

(j) **Welding of Nuts & Bolts**

Measurement for measurement will be made for each tower.

Payment will be made on the unit price quoted for each tower. The unit prices shall include, but not limited to welding of nuts & bolts up to 8.0 m height and application of galvanox as specified in technical provisions and price schedule.

(k) **Stringing OPGW and Conductor**

Measurement for payment will be made horizontally along the center line of the line route.

Payment will be made based on the unit price quoted in the Price Schedules as per the following percentage for:

Conductor

60% upon completion of stringing & sagging,
25% upon completion of dead-ending & Clipping
07% upon installation of jumpers and
08% upon installation of dampers.

OPGW

70% upon completion of stringing & sagging,
15% upon completion of dead-ending & Clipping and Installation of Dampers
15% upon installation of Splicing & Joint Boxes.

The unit prices shall include, but not be limited to, the cost of all labour, equipment, requisitioning, loading, transporting, distributing, stringing including but limited up to the installation of insulator, OPGW hardware assemblies; accessories for conductor and OPGW along with associated equipment; spacer dampers for conductor and stock bridge type vibration dampers for OPGW, sagging, clipping-in, dead-ends, jumpers including installation of spacer, together with all hardware as shown on the relevant drawings, and all other associated work necessary for the completion of this phase of the work.

(l) **Erosion and Slope Protection**

Payment will be made for the erosion and slope protection of the respective tower leg as per the approved drawing on the instruction of the Engineer.

Measurement of the work done will be calculated as per actual construction and payment will be made from the Additional Works.

SP-14 PAYMENT FOR WORKS REQUIRED BY SPECIAL PROVISIONS

Unless expressly excluded, the cost of all Works required by the "Special Provisions" shall be considered to be included in the price and amounts quoted in the Price Schedules.

SECTION VII
SPECIFICATIONS –
TECHNICAL PROVISIONS

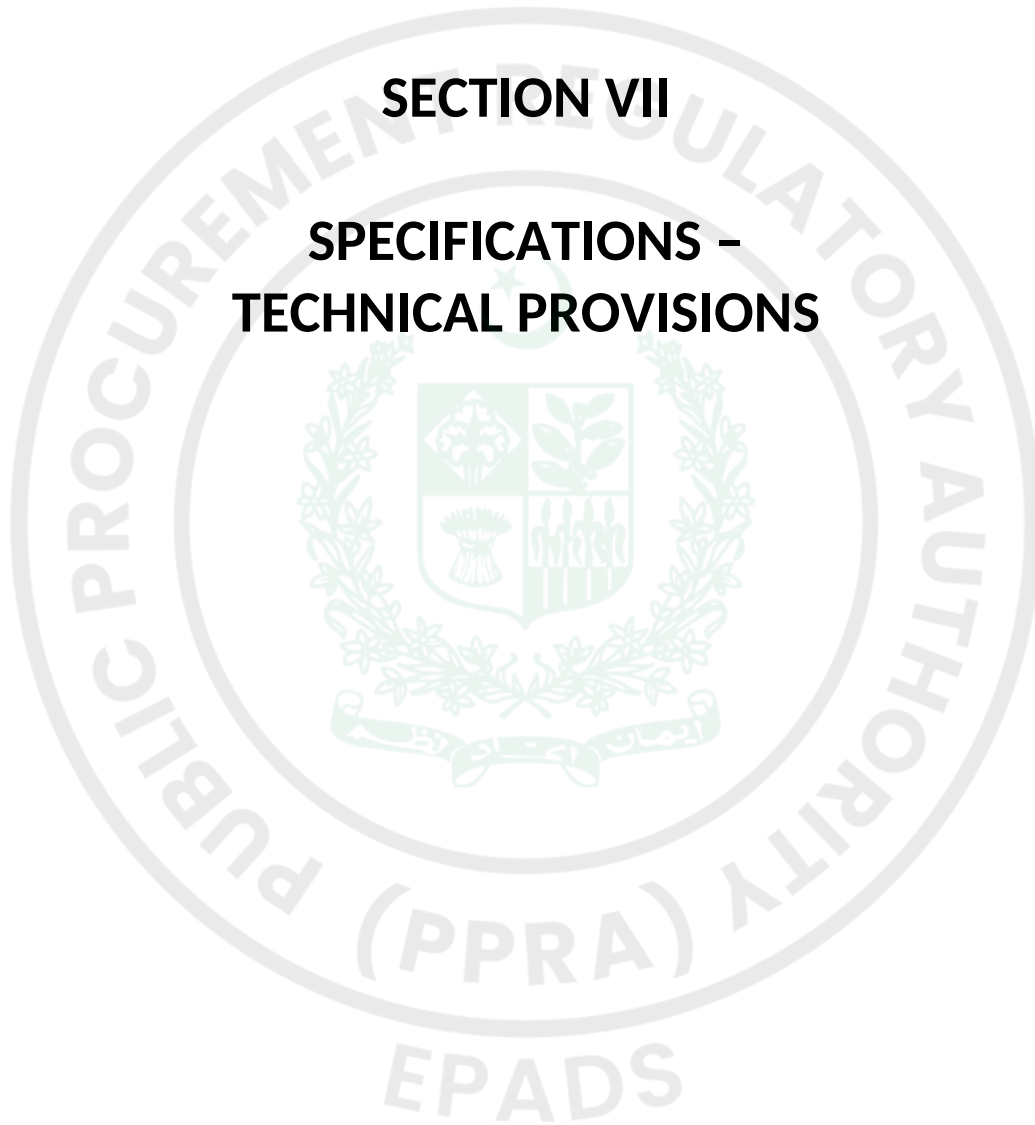

1. SPECIFICATIONS - TECHNICAL PROVISIONS

1.1 General

(1) Clearing Right-of-Way

Right-of-Way clearing shall be restricted to the minimum necessary for the safe construction and operation of the line. Clearing shall generally consist of brushing out the center line, tower locations and conductor pulling sites within 25 meters on each side of the center line. Trees over 2.5 meters in height which constitute a hazard or danger to the transmission line, or whose tops are within 6 meters at 75°C final conductor sag position, shall be removed. In addition, tall trees outside the cleared area, of such height that they could fall within 5m of the outermost conductor shall be removed/trimmed.

The clearing of desert vegetation, bushes and trees shall be restricted to that required for placement of footings and for the assembly and erection of towers and wire pulling Site.

No clearing will be allowed in orchards or other areas of fruit bearing trees, except as specifically approved by the Engineer.

The cleared materials will be the property of the Land Owner/ Authorities. The Contractor shall be responsible for compacting and re-leveling the ground to the original surface level and gradient. Where agreed by the Engineer a percentage of the soil may be disposed-off by local spreading. Reinstatement of trees to a standard at least equal to the condition of the site before construction shall be made. If any disposal of cleared material is required, it will be disposed of by burning or other methods approved by the Engineer.

The contractor shall immediately establish the Right of Way and clear trees, and any obstructions or hindrances after mobilization, and obtain approval from the local authorities in the execution of work so that there will be no delay in execution/completion of the various activities and work will be completed as per schedule. The contractor shall also bind his labor and staff to use the minimum area during the execution of the work.

(2) Survey and Profiling

The transmission line route marked on SoP sheets is firm and final as established by the Employer and is shown in the specification's drawings. However, the Contractor shall check the line route before starting the field ground survey. Plan & profile drawings prepared on PLS-CADD (Version 16.20) will be handed over to the Contractor after the award for execution.

For Diverted Route only:

The Contractor shall be responsible for carrying out a detailed survey using RTK, preparing a plan and profile, tower spotting using PLS-CADD software (Version 16.20), and preparing the construction structure list accordingly. In case the

contractor intends to use the latest version of the software then the same software shall be provided to the Consultant for their review and checking.

The work to be done by the Contractor shall include but not be limited to the following:

- (i) Before starting the work, a walkover survey shall be carried out of the line route in light of the plan & profile drawings.
- (ii) If any line diversion along the proposed transmission lines routes is necessitated as decided/approved by the Engineer, the Contractor will carry out an investigation of the route along with necessary plan tabling of the area and shall make necessary modifications and establish the terminal points, angle's locations, road crossings and other points of interest as advised by the Engineer or his nominated person.

All the proposed modifications are then to be transferred onto the route map by the Contractor and submitted to the Engineer for approval.

- (iii) The Contractor shall be responsible for obtaining clearances, permissions, and approvals for the entire line as well as for diverted portions from various statutory bodies/authorities like the Forest Department, Aviation Authorities, National Highway Authority, Pakistan Environmental Agency (KPK), etc. The Employer will provide complete assistance to the Contractor; however, the responsibility lies with the Contractor for submission of the required details, and follow-up with the statutory bodies for obtaining the approval.
- (iv) During the survey, the Contractor will ascertain whether the route indicated to him is most desirable. If in his opinion another route would be more desirable on technical grounds or more economical, he shall report his findings to the Engineer who will then decide about the adoption of the new route.
- (v) The survey shall be executed using RTK equipment. Ground elevations are to be taken at regular intervals and locations of change of slope and for various features like roads, rail tracks, canals, power & communication lines, water courses etc.
- (vi) The Contractor will install the concrete markers of at least 130 x 150 mm at top and bottom with a height not less than 1m. The markers shall be buried 0.5 m below the existing ground level. The markers shall be white-washed and a red point shall be made on the top of the marker to indicate the exact center of the line.
- (vii) Total accumulated error in longitudinal and transverse measurements should not exceed 0.05% and in the vertical direction should not exceed 0.20%.
- (viii) Longitudinal profiles and strip plans are to be prepared by the Contractor in the following scales:

Horizontal	1: 2000
Vertical	1: 200

and shall be submitted for Engineer approval. The profile shall be prepared on plans of 700 mm x 2000 mm size, or other size approved by the Engineer. Each sheet shall repeat 1/5 km of the route on either side. Also, the sheet numbers shall be indicated on a key map for reference.

- (ix) Profiles shall include all details relevant to the survey of the routes including the position of concrete markers, crossings, transversal slopes, location of forest reserves, population limits, and position of the road.

The ground profile shall be along the route centre line of the approved route. All obstacles and important features within 50 meters on either side shall be shown on the profiles.

Tower spotting shall be carried out by the Contractor using PLS-CADD software for the ACSR "Rail" conductor taking into account the maximum & minimum temperatures as 75°C & -5°C. The Contractor shall validate and establish the minimum mid-span ground clearance of 8m complying with the Electric and Magnetic field exposure guidelines for 50Hz.

The tower positions shall be verified for suitability. Templates of various spans will be provided free of cost to the Engineer on PVC sheets with at least 1mm thickness indicating hot, cold, and ground clearance curves.

The construction structure list shall be prepared by the Contractor as approved by the Engineer.

- (3) Updating of the provided plan & profile drawings and construction structure list of the proposed transmission line route to prepare as-built drawings.

UTM Coordinates by hand-held GPS (with 3m accuracy) of each tower should be collected and submitted to the Engineer.

(4) **Tower Staking**

Staking (centre and reference pegs) of the tower locations that have to be concreted are included in the contractor's scope.

Tower centres shall be staked in the field along with two reference stakes/pegs on either side of the tower along the line route, using wooden pegs. All angle tower locations shall be bisected.

Surveying is not mentioned in these specifications as being the responsibility of the Contractor. This shall include, but not be limited to the location of tower footings.

The footing for the terminal dead-end tower shall be so placed that the transverse axis of the tower cross-arms shall be parallel to the transverse axis of the gantry structures of the substation up to 20° line angle. If the line angle is more than 20° then the terminal dead-end tower location shall be bisected.

(5) **Contouring at hilly / undulated locations**

The up or down level of each footing center with reference to the center of the tower location shall be recorded at intervals of 1 meter up to 20 meters using total stations/digital theodolite and digitized contour plans shall be made. Based on the digitized elevation plans unequal leg extensions shall be decided for particular tower locations and approved by the Engineer.

1.2 Confirmatory Sub Soil Investigation

The Work specified herein is to determine the type and geotechnical characteristics of the foundation strata to the specified depth and location. This is to be accomplished through wash boring or rotary (including rock coring) drilling or percussion, field testing, groundwater observations, soil sampling, and laboratory testing. The location along with the depth of investigation boreholes on the ground shall be established by the Contractor following the Drawings and from reference points to be approved by the Engineer as per requirement. The Contractor shall have at the site, at all times only a qualified experienced geologist/engineer who will conduct and supervise drilling/logging activities. Hand-held GPS should be available at the investigation site for verification of borehole/test pit location by the Engineer.

(a) Method of Drilling

Drilling shall be done by rotary (including rock coring) or wash boring, percussion method or the combination of two methods by means of which a hole of specified diameter is extended in depths. Use of bottom discharge drilling bit shall not be permitted. The contractor shall be allowed to use the percussion method where gravels & boulders are encountered.

(b) Drilling of boreholes in flowing water conditions

Drilling may be carried out underwater conditions. During the investigation, the Engineer may change such locations to land drilling depending on the prevailing waterway conditions.

(c) Test Pit

The test pits shall be excavated at the locations as approved by the Engineer. Excavations of test pits shall be made to the depths as directed by the Engineer by manual labour and with the help of suitable digging tools. Test pits shall generally be excavated to a depth of about 3 meters below the ground surface or bedrock whichever is encountered earlier. An undisturbed block (30cmX30cmX30cm) sample shall be extracted from each test pit. The dimension at the bottom of pit shall not be less than 1.5 m x 1.5 m. After field testing and sampling, the test pit should be backfilled as instructed by the Engineer.

(d) Drilling Fluid

The drilling fluid used for rotary drilling or wash boring or percussion shall be clean water clear from suspended sediments. The Contractor may use the natural or commercial drilling mud/bentonite slurry as drilling fluid.

(e) Casing of Boreholes.

- (i) Casing of a required size allowing entry of sampling tools shall be used in conjunction with drilling to wall the boring to the bottom of the hole.
- (ii) The casing shall be made of cylindrical steel pipes and shall have sufficient strength so as to maintain position and shape during drilling operations.
- (iii) The casing may be omitted only where it can be shown to the satisfaction of the Engineer that sampling operations without the casing will not entrain soils from an elevation higher than the depth at which field testing or sampling is to be made.
- (iv) It shall be the Contractor's responsibility to pull out casing from the boreholes after its completion for which no extra payment shall be made.

(f) **Field Testing**

Field testing shall include Standard Penetration Test. Standard Penetration Test shall conform to ASTM D-1586. This designation describes a procedure to obtain a record of the resistance of subsoil to the penetration of a standard sampler and to obtain representative disturbed samples of the material for identification purposes and laboratory testing. The penetration resistance shall be expressed as the number of blows of a 63.4 kg (140 lbs.) hammer freely dropping 762 mm (30 inches) required to force the standard sampler 305 mm (12 inches) into the soil. Standard Penetration Tests shall be conducted in the boreholes at a 1-meter interval from 1-meter depth to the bottom of the borehole unless otherwise directed by the Engineer. Immediately after each penetration test a representative portion of the soil core shall be placed in a moisture-proof container.

(g) **Undisturbed Sampling**

The undisturbed samples shall be taken in cohesive and non-cohesive materials. Samples shall be obtained using Denison or Pitcher sampler or equivalent double tube core barrel or Shelby tube. The sampling procedure shall conform to the latest B.S./ASTM Standards. The length of undisturbed samples obtained shall not be less than 30 cm. Immediately upon extraction from the hole, the sample shall be properly waxed. The number and depth of undisturbed samples from each hole shall be as directed by the Engineer during the progress of the drilling work at the site.

(h) **Labeling and Disposition of Samples**

Each sample including cores shall have identification tags giving information regarding Sample No., Top Elevation of Hole, Date of Sampling, Depth, and Length of Sample, and Description of Sample.

The selected undisturbed and disturbed samples shall be carefully transported for testing by the Contractor to the approved testing laboratory. Every precaution shall be taken to avoid damage to samples as a result of careless handling and undue delay in transportation. The tubes containing undisturbed samples & rock cores shall be well-packed in wooden boxes to protect the samples against vibration.

(i) **Ground Water Observations**

Whenever required by the Engineer, boreholes shall be preserved for observations of groundwater conditions. When the borings are advanced by using natural or commercial drilling mud/bentonite to stabilize the hole, the hole shall be flushed thoroughly with clean water after the boring to observe groundwater levels. After field testing and sampling, the borehole should be backfilled as instructed by the Engineer

(j) **Laboratory Tests**

(i) **General**

- The laboratories in which the samples are to be tested shall be approved by the Engineer [preferably CMTL Lahore, UET(s)].
- The person representing to the Engineer shall have access to the laboratories to supervise and check the laboratory testing of the samples.
- The testing shall be carried out in accordance with ASTM or equivalent British Standards, or as directed by the Engineer.

Laboratory tests shall be conducted using approved apparatus complying with the requirements and specification of International Standards for this type of work. It shall be checked that the apparatus are in good working condition before starting the laboratory tests. Calibration of all the instruments and their accessories shall be done carefully and precisely at an approved laboratory.

One copy of all laboratory test data records shall be submitted to the Employer. Laboratory tests shall be carried out concurrently with the field investigations as initial laboratory test results could be useful in planning the later stages of field work.

(ii) **Tests**

The Contractor shall arrange to carry out laboratory tests on the specified samples of the subsoil material. The samples to be tested and the tests to be carried out for each sample shall be specified by the Engineer. Laboratory testing may include but is not limited to the tests listed below:

Grain Size Analysis (Sieve + Hydrometer)

Soil Classification with percentage of gravel, sand, silt and clay at different depths.

Safe Soil Bearing Capacity (particularly at 5m depth)

Atterberg's Limits

Chloride Content (soil and water)

Bulk Density and Moisture Content

Dry Density

Generalized Subsurface Geotechnical Models with tables showing soil characteristics for each tower location

Capacity Curves at 4, 5, 6, 7m depths and Allowable Load vs Foundation Width for different Models.

Organic Matter Content

Sulphate Content (soil and water)
 PH value (soil and water)
 Unconfined Compression Test
 Direct Shear Test
 Consolidation Test
 Total Soluble Salts.

(l) **Record**

The Contractor shall have at site, at all times only qualified, experienced, orderly and thoroughly competent graduate Geologist who shall conduct and supervise drilling operations sampling and logging.

Contractor shall submit a formal report containing geological information of the region, procedures adopted for geotechnical investigation, field observations, summarized test data, conclusions and recommendations. The report shall also include detailed bore logs, subsoil sections, field test results, laboratory observations and test result both in tabular as well as graphical form, practical and theoretical considerations for the interpretation of test results, supporting calculations for the conclusions drawn etc.

The Contractor shall keep accurate logs and records of all the Work accomplished under this Contract. All such records shall be preserved in good condition by the Contractor until they are delivered and accepted by the Engineer. The Engineer shall have the right to examine such records at any time prior to their delivery to him. The following information shall be included in the records for each investigation borehole:

Bore hole/test pit number or designation, coordinates and elevation of top of the bore hole/test pit;
 Type of drilling operations;
 Dates and time by depths when drilling operations were performed;

Depths at which samples were recovered and field-testing was performed including complete data of field-testing;
 Depth of Ground water table from NSL; and
 Description of subsoil conditions.

The presence of the Engineer Representative or keeping of separate records by him shall not relieve the Contractor of the responsibility for the Work specified in this clause. Payment will not be made if the Contractor has not furnished the records.

(m) **Foundation design/designation (in light of confirmatory investigation)**

The contractor shall submit the foundation design/designation along with the following data/calculations to establish that the proposed foundation type is optimized and cost-effective for the review and approval of the Engineer:

- Necessary soil design parameters to verify the bearing capacity based on geological data (bore log) and laboratory test results i.e. from (a) standard penetration test & (b) analytical method.
- Immediate and consolidation settlements of soil.
- Seasonal fluctuation of groundwater (at least 1m from the observed).

- Cement type to be used for foundation construction (based on ACI-318 Table 4.3.1).

The Contractor shall propose suitable foundation design on the basis of soil investigation. If it is determined that a new foundation design, other than those being already used by NGC, is required depending on the soil investigation results, the Contractor would design such new foundations types such as grillage foundation, undercut foundation, rock-anchor foundation, augured foundation etc. The Contractor shall be responsible for satisfactory performance of new foundation after erection and commissioning of towers on these foundations. Price of Design of new foundation would be quoted on “per type of foundation” basis.

1.4. FOUNDATION REQUIREMENTS

(1) General

The items of the Price Schedules for constructing the various types of concrete foundations (including pile foundations) for steel towers include the following:

- (a) Tower staking;
- (b) Performing all clearing, grading, cutting, blasting, and levelling as required to construct the footings and erect the steel towers at the specified tower locations;
- (c) Performing all required excavation, blasting (in all types of soil/ gravels & boulders/rock), dewatering, shuttering, curing, and compacting backfill for the concrete footings;
- (d) Installing steel stub angles in the concrete footings;
- (e) Tower grounding before placement of concrete;
- (f) All concrete work for the concrete footings, including the cost of furnishing all reinforcing bars, and all materials for concrete;
- (g) Installing pile foundations where required, including the cost of furnishing all reinforcing bars and all materials for concrete; and
- (h) The foundation drawings included in Bidding Document are firm & final and only be changed (if required) as directed by the Engineer.

The specific requirements for performing the individual portions of the Work to construct the concrete foundations are included in the paragraphs about the individual Work to be performed.

(2) Excavation for Tower Footings

The Contractor shall perform all excavation required for constructing various types of concrete foundations for the steel towers. During excavation of towers sites near to amenities, the Contractor shall ensure to perform the work in such a

manner as to minimum damage to them and if any prior approval is required that must be obtained at his own. However, in case of any damage the Contractor shall be get repair of it at his own risk and cost under intimation to the concerned agency.

Where foundations are installed on sloping or unstable ground the Contractor shall be responsible for ensuring the local and overall stability of the area, the safety of the public, and any other structure. Utmost effort should be made that the natural slope should not be disturbed by using unequal leg extensions or foundation with chimney extension to avoid unwanted landslides. To excavate and construct the foundation, vertical cutting to the adjacent natural slope is not allowed.

To protect the overall and localized stability of the natural slope, the adjacent natural slope shall be cut in steps (terraces) to prepare the multi-step platforms. The work methodology and drawings shall be submitted by the contractor to the Consultant for approval. Further stabilization shall be achieved by approved methods such as retaining walls, buttresses, gabion baskets/mattresses, stone masonry, and shotcreting. The set level of the tower location on the sloping ground will be finalized by the Engineer's representative before excavation.

The tower sites shall be levelled and cleared of trees, brush, and stumps as may be required to construct the tower footings and to erect the steel towers. Cleared materials shall be disposed off, as directed by the Engineer or his nominated person.

All excavations shall be sufficient to provide concrete footings with dimensions not less than shown on the drawings.

After the Contractor has excavated the footing to the required depth, the Engineer's Representative will inspect the bottom of the excavation and determine if the bearing material is suitable for the type of footing designated for that location. If it is found that the bearing material is unsatisfactory for the type of footing designated, the Engineer or his nominated person will either designate another type of footing or ask for compacted crushed stone mixed with sand (50:50 ratio) to be placed underneath the footing for a depth of up to 1.2 meters. The Contractor will be paid only for the type of footing installed. However, no payment will be made for the additional excavation and replaced compacted material underneath the footing.

A maximum variation of 60 mm above or below the established grade will be permitted. However, if excavations are below the specified grade plus tolerance, those shall be backfilled to the required grade by the Contractor with the Contractor's furnished concrete at his own cost.

All excavated material that is suitable for backfilling as approved by the Engineer shall be laid aside to be used for backfilling at the tower site from which it was excavated. The backfilling shall be done in layers (not more than 300mm) with a roller compactor or plate compactor as approved by the Engineer. The excess material shall be spread evenly around the site as directed by the Engineer or his nominated person.

Concrete shall be placed as soon as practicable after each excavation is completed and all excavations shall be protected to maintain a clean sub-grade until the footing is placed, using dewatering, timbering, shoring, or casing, as necessary. Any sand, mud, silt, or other objectionable material which may accumulate in the excavation shall be removed at the expense of the Contractor before placing concrete. After the completion of the foundations, all the dewatering holes shall be filled with dry sand.

(3) **Rock Excavation**

Rocks shall be excavated to the depth required to provide a suitable base for the foundations as indicated on relevant drawings. Rocks are classified as sound and mashes, layers or ledges of mineral material 0.241 cubic meters in volume in place and of such hardness and texture that it cannot be easily loosened or broken down.

Rock excavation includes drilling, blasting, removal of drainage, and pumping as required. Drilling and blasting techniques shall keep over-break to a minimum and no extra compensation shall be paid for the removal of over-broken material. The contact surface of the rock shall be cleared of all loose rock and soil.

The Contractor shall familiarize himself and comply with the laws and local customs concerning the use, handling, and storage of explosives. The cost of any damage whatsoever caused by blasting shall be payable by the Contractor. He shall not be relieved of these costs despite having received approval of his methods from the Engineer.

(4) **Erosion/Slope Protection**

For erosion protection against water current, gravel blankets shall be placed, as per Specification Drawings with the approval of the Engineer, such that they do not flow away with water current. These gravel blankets shall be placed at or adjacent to tower sites in the manner directed by the Engineer or his nominated person. Gravel for the blankets shall be furnished by the Contractor, and it shall be pit-run, free draining, containing no stones larger than 635 mm size obtained from the closest source approved by the Engineer or his nominated person. The gravel shall be reasonably clean and free from vegetation, pieces of timber, or other foreign matter, and shall be distributed and graded evenly over the required areas. To protect the overall and localized stability of the natural slope, the adjacent natural slope shall be cut in steps to prepare the multi-step platforms. The work methodology and drawings shall be submitted by the contractor to the Consultant for approval.

Slope protection will be provided for foundations, as per Specification Drawings with the approval of the Engineer, which are located/placed on uneven ground, sloping terrain in the hilly areas, and/or they are partially or fully exposed in such a way that designed over-burden cannot be provided on these foundations safely. Slope protection shall include but not be limited to the construction of retaining walls of stone masonry to a height and depth to provide adequate protection and necessary burden by making a levelled platform with stone mortar after filling with the earth as per Specifications Drawings or as directed by the Engineer. Where in the opinion of the Engineer, gabions are required for the protection of the foundation these shall be installed as per the following specifications:

- (a) The gabion wire mesh workmanship, strength, and block sizes shall conform to ASTM A975. The size of a typical gabion wire mesh shall be 83x114x3.05mm. The length, width, height, and number of cells of gabion blocks shall be as per ASTM A975. However, typical sizes of gabion blocks may be adopted as 1.5mx1.0mx1.0m, 2.0mx1.0mx1.0m, and 4.0mx1.0mx1.0m as required.
- (b) The box gabion shall be a rectangular basket fabricated from a double twist, hexagonal mesh of soft annealed heavily galvanized wire. It shall be filled with rounded river or quarried stone of suitable size.
- (c) All the edges of the main base and end panels shall be reinforced with galvanized wire of greater diameter. The selvages wires, in addition to strengthening the basket, facilitate its assembly and assist in keeping it square.
- (d) Where there is more than one course of gabions, the ones in the upper course shall be securely laced to those below.
- (e) An un-weathered (sound) naturally occurring angular or crushed hard rock material can be used for filling. Stone for the Gabion facia shall be hard, angular to round, durable, and of such quality that they shall not disintegrate on exposure to water or weathering during the life of the structure. The minimum and maximum size of the stone used for filling shall be 1.5 to 2.5 times the mesh opening. Each range of sizes may allow for a variation of 5% oversized rock by the number of particles, 5% undersized rock by the number of particles, or both. The rock pieces should be properly hand-placed and packed with their larger dimensions in the horizontal position. The size of any oversized rock shall allow for the placement of a minimum of three layers of rock must be achieved when filling the 1 m high units and a minimum of two layers for the 0.50 m high gabion units and 0.3m thick gabion mattress. Los Angeles abrasion value is Not more than 45.
- (f) After filling the gabions slightly over-full, to allow for subsequent settlement, the lid shall be laced down with binding wire to the tops of all sides and diaphragm panels.

(5) Concrete Foundations

Each tower foundation will have four footings and each footing will consist of a steel stub angle embedded in reinforced concrete. The footings for each tower in a tangent section of the line shall be placed so that the longitudinal axis of the tower cross-arm will lie in a plane perpendicular to the traverses of the line. Unless otherwise directed by the Engineer, the footings for each angle tower shall be placed so that the tower cross-arm will lie in a plane bisecting the interior angle formed by the intersection of the traverses of adjacent sections of the line.

The footings at the various tower sites shall be constructed following the criteria shown on the Specifications Drawings. The concreting can be done with rotary and buckets or portable concrete pump or a mobile truck with a transit mixer as approved by the Engineer.

Pile foundations will be required where the field and laboratory tests confirm the requirements. The pile foundations will be installed as shown on the relevant drawings and following these Specifications.

All pile foundations as shown on drawings are of a preliminary nature and depths of piles have been indicated for bidding only. The final design may vary for the length and diameter of the pile and other details shown on the drawings.

Any type of spread footing foundation may be changed to another type of spread footing foundation or pile foundation following field requirements during the execution of the project.

A brace beam may be required/constructed to tie all four footings of the tower as approved by the Engineer for which payment will be made from the Additional Works.

(6) **Placing of Stub Angles in Footings**

Stub angles shall be placed in the tower footings as shown on the drawings and shall be supported in the proper position using a rigid frame or equivalent suitable device to ensure placement of the stubs within the tolerances specified below. The stub angles shall be held rigidly in a manner to prevent displacement during the placing of concrete. In the case of the use of a concrete block at the bottom of the stub, its minimum compressive cylinder strength should be 3000 psi at 28 days. The stub should extend into the footing pad and in case of cutting or making new holes in the stub no price compensation will be made to the Contractor

All stub angles for the tower legs shall be set accurately to the grade and alignment designated on the drawings and as directed by the Engineer. Work that is not within the tolerance will be corrected as directed by the Engineer and at the Contractor's expense. The setting tolerances following complete foundation installation including backfilling and compacting are as follows:

- (a) Tower Center from theoretical location:
 - (i) Transverse ± 150 mm
 - (ii) Longitudinal ± 500 mm
- (b) Tower Orientation (angular departure from the theoretical location measured at the point of intersection of a tower face and the longitudinal center-line) 25 mm
- (c) Difference in Elevation between working point marks on Stub Angles including diagonally opposite legs 8 mm
- (d) Departure from theoretical Horizontal Dimensions between tower centre line and working point marks on stub angle:
 - (i) Along the tower face ± 5 mm
 - (ii) Along the tower diagonal ± 7 mm
- (e) Batter 5 mm/m

(f) Twist (about the heel of stub angle) 2°

(7) **Tower Grounding**

Tower Grounding shall be performed following the grounding schemes provided in the Specification Drawings.

Ground rods shall be driven at least 2.5 meters into undisturbed soil at the bottom of the footing excavation, as shown on the Drawings. The ground rod shall be connected to the stub angle by the specified ground wire. The connection of this wire to the ground rod and the stub angle shall be made by a bolted clamp following the drawings.

Where it is not possible to drive a ground rod an alternative grounding by installing 'crowfoot' shall be adopted following the specified drawing.

The resistance of the two rods/crowfoot in parallel shall be measured and recorded before concrete is poured for footings. If the resistance is more than 10 ohms, an additional grounding arrangement shall be installed as directed by the Engineer or his nominated person following the specified drawing until the time the specified grounding resistance is achieved. No extra payment would be allowed for excavation/blasting/laying/back-filling on account of this.

The dead-end terminal tower of the overhead lines must be connected to the earthing system of the grid stations.

(8) **Concrete**

(a) **General**

All concrete and reinforcement placed for tower footings shall conform to the requirements of this section.

At least 30 days before the beginning of the concrete placement, the Contractor shall submit to the Engineer for approval, a design mix (along with quantity and source of each material) along with six (6) test cylinders using the actual materials to be incorporated into the Work. Approval of the design mix will in no way relieve the Contractor from meeting all the requirements of these Specifications. Whenever the Contractor proposes to use a different material source, a new design mix must be submitted and approved as outlined above. During construction if in the Engineer's opinion, the mix should be adjusted, the Contractor shall submit a new design mix as directed by the Engineer.

(b) **Materials**

The Contractor shall furnish all materials for use in concrete, including but not limited to cement, sand, coarse aggregate, water, reinforcing bars, admixture (including ground slag), and concrete curing compound. Air-entraining agent and curing compound shall be accepted on the Contractor's certification of compliance with specification requirements. However, the Engineer reserves the right to require submission of and to perform tests on

samples of the agent and/or compound before the shipment and use in the Work at the cost of the Contractor.

(i) Cement

Cement shall meet the requirements of ASTM C150. The cement shall be free from lumps and properly packed in bags when used in concrete. Adequate provisions shall be made by the Contractor to prevent the absorption of moisture when cement is stored. Cement Type-V (sulfate resistant cement) will be used. No extra payment shall be made to the Contractor in case of the use of sulfate-resistant cement. The volume of one bag of cement should be taken as 1.25 cubic ft.

Cement Mill Test Certificates, when requested, shall be provided for each shipment of cement. Under no circumstances shall the source of cement be changed without prior written approval of The Engineer.

(ii) Sand and Coarse Aggregate

Sand and coarse aggregate shall be furnished from any approved source. The sand particles shall be clean, hard, dense, durable, uncoated rock fragments that will pass a screen having 6.5 mm square openings. The sand shall be well-graded from fine to coarse and shall be free from injurious amounts of dirt, organic matter, and other deleterious substances.

The coarse aggregate shall consist of clean, hard, dense, durable, uncoated rock fragments, and shall be free from injurious amounts of flat and elongated pieces, organic matter, or other deleterious substances. The maximum size of crushed coarse aggregate for piles shall be 19 mm and for spread footings, pile cap, and tie beam 38 mm or as directed by the Engineer. The grading of these sizes shall conform to ASTM C33.

The Contractor shall submit, for testing and approval, representative samples of the sand and coarse aggregate proposed for use in the concrete work. All aggregates shall conform to the requirements of ASTM C33 including the Petrographic test. During construction, the Contractor shall also arrange testing of sand and coarse aggregate if directed by the Engineer to determine compliance with Specifications. The cost of all laboratory testing of these samples shall be borne by the Contractor.

(iii) Water

Water used for mixing concrete shall be clean and free from injurious amounts of oils, acids, alkalis, salts, organic materials, or other substances that may be deleterious to concrete or reinforcement and shall meet the requirements shown in Table 1 below. A complete chemical analysis of water shall be submitted before the start of construction work and shall be required for each new water source being chosen. The cost of all laboratory tests of the samples shall be borne by

the Contractor. No change in water source shall be permitted without prior approval by the Engineer

TABLE-1

Total Dissolved Solids (TDS)	800 ppm (max)
Magnesium, Chlorides and Sulfates	250 ppm (max)
pH Value	6.5 – 8.0

(iv) Reinforcing Bars

Reinforcing bars shall be deformed bars conforming to ASTM Designation A615, Grade 60. Representative steel bar samples shall be collected from the site and tested in CMTL Lahore or UET(s). The testing shall be witnessed by the representative of the Engineer. The cost of all laboratory tests and travelling of the Engineer's representative shall be arranged/borne by the Contractor. Negative variation in weight [mass] maximum up to 2.0% of reinforcement bar(s) from the applicable weight [mass] per unit length prescribed in Table 1 of ASTM A615 will be allowed for bar(s) placement. The contractor will have to make adjustments in bar spacing/number of bars to accommodate the excessive negative variation in weight [mass] if greater than 2.0%. The contractor will not be allowed for bar(s) adjustment in case of overweight [excessive mass] of any deformed bar.

(v) Protective/Sealing compound

Bitumen emulsion protective coating conforming to ASTM C 309 shall be applied (at least two coats) to all exposed surfaces of concrete.

(iv) Admixtures and Ground Slag

Admixtures to be used in concrete shall be subject to prior approval of The Engineer and shall meet the following requirements:

(A) Chemical Admixtures

- (i) Air-entraining admixtures shall conform to ASTM C 260, "Specification for Air-Entraining Admixtures for Concrete.
- (ii) Water-reducing or water-reducing and retarding admixtures (Normal Plasticizers) shall conform to ASTM C 494, "Specification for Chemical Admixtures for Concrete", Type A or D, respectively.
- (iii) High-range water-reducing or retarding admixtures (superplasticizers) shall conform to ASTM C 494, Type F, or G, respectively.
- (iv) Only one of the Admixtures A, D, F, or G, shall be added at a time.
- (v) Chloride-bearing admixtures shall not be permitted.
- (vi) Super Plasticizers shall be checked for their compatibility with pozzolanic materials in blended cement concrete.

(B) Ground Granulated Blast-Furnace Slag

In the area where high sulfate & chloride contents are present in soil/water, finely ground granulated blast-furnace slag can be used as a cementitious material in concrete by replacing OPC/SRC cement by a maximum of up to 30%. The properties of ground granulated blast-furnace slag should meet ASTM C 989.

The cost of all laboratory testing of these samples shall be borne by the Contractor. The contractor will not be paid extra for the procurement of ground granulated blast-furnace slag for the construction sites.

(c) **Composition**

The Contractor shall determine the proportions of the sand, coarse aggregate, and cement needed to provide concrete, meeting the requirements of these Specifications, and shall be approved by the Engineer. Concrete that contains 38 mm maximum-size aggregate shall have a cement content of not less than 380 kg per cubic metre and concrete which contains 19 mm maximum-size aggregate shall have a cement content of not less than 440 kg per cubic meter. 38 mm maximum size aggregate shall be used for spread footing, pile caps, and tie beams, and 19 mm aggregate for piles. The net water-cement ratio by weight shall not exceed 0.5. Surface water contained in the aggregate shall be included as part of the mixing water in determining the water content. The reinforced concrete design will be checked in accordance with the ACI Building Code.

The Contractor will take a minimum of three test cylinders (152 mm x 305 mm) per leg, and the average compressive strength at 28 days shall exceed 210 kg/cm² (3000 psi) and no individual test value should fall more than 35 kg/cm² (500 psi) from the minimum specified value.

The compressive strength of the concrete will be determined by the Engineer through the medium of test of (152 x 305 mm) cylinders made and tested following ASTM C39. The Contractor shall furnish all necessary sampling equipment such as slump cones, test cylinders, etc. at the site. This equipment is to be approved by the Engineer or nominated person by the Engineer. The cost of the material lab tests shall be borne by the Contractor.

In the event that the concrete cylinder fails to meet the specified strength requirements then in-place testing of concrete shall be conducted under the supervision of the Engineer. In-place as approved by the Engineer testing of concrete shall be conducted by one or a combination of the following methods:

- (i) ASTM C42 "Test Method of Obtaining and Testing Drilled Cores and Sawed Beams of Concrete."
- (ii) ASTM C805 "Test Method of Rebound Number of Hardened Concrete."

The use of calcium chloride in concrete will not be permitted.

The slump of the concrete shall not exceed 75 mm for conventional foundation, pile cap & tie beam, and 150-175 mm for piles.

(d) **Batching and Mixing**

Unless specifically approved by the Engineer, all concrete used on the Project shall be machine mixed. Hand mixing shall only be used when authorized by the Engineer, and shall be performed under his directions.

The sand and coarse aggregate shall be weighed and shall be proportioned based on integral bags of cement unless the cement is weighed. After weighing, the materials may be proportioned based on equivalent volumes. The Contractor shall provide equipment and shall maintain and operate the equipment as required to accurately determine and control the amount of each separate ingredient entering the concrete. Batching shall be such that combined inaccuracies in feeding and measuring the materials will not exceed 1.5 per cent for water and weighed cement and 2 per cent for sand and each size of coarse aggregate. The concrete shall be uniform in composition and consistency throughout the mixed batch, and from batch to batch, except where changes in composition or consistency are directed. The mixing time shall be at least 1.5 minutes for stationary mixers. Excessive over-mixing requiring the addition of water to preserve the required consistency will not be permitted. The temperature of the concrete, when it is being placed, shall be not more than 35°C and not less than 5°C in moderate weather or 10°C when the mean daily temperature drops below 5°C. Truck mixers will be permitted only when the mixers and their operation are such that the concrete throughout the mixed batch and from batch to batch is uniform for consistency and grading. Any concrete retained in truck mixers so long as to require additional water to permit satisfactory placing shall be wasted.

(e) **Forms Preparation for Placing of Concrete**

Unless otherwise provided for on the Drawings or approved by the Engineer, all concrete placed will be monolithic.

Forms shall be sufficiently tight to prevent loss of mortar from the concrete and shall be maintained rigidly in position until the concrete has hardened sufficiently to prevent damage by form removal. All surfaces of foundations upon or against which concrete is to be placed shall be free from standing water, mud, and debris. The surfaces of absorptive foundations against which concrete is to be placed shall be moistened thoroughly so that moisture will not be drawn from the freshly placed concrete. The surfaces of construction joints shall be clean, rough, and surface dry when covered with fresh concrete. Cleaning shall consist of the removal of all laitance, loose or defective concrete, coatings, sand, curing compound if used, and other foreign material. A mortar layer shall not be used on concrete construction joints.

The methods and equipment used for transporting concrete, and the time that elapses during transportation shall be such as will not cause appreciable segregation of coarse aggregate or slump loss above 25 mm in the concrete as it is delivered into the Work. Concrete may be transported from the mixer to the forms and deposited in the forms by any method approved by the Engineer such as transit mixers, buckets, chutes, and pumping. Aluminum pipe or chutes shall not be used for tremie trunk line, or chute for placing of concrete, or for the delivery of pumped concrete. Re-tempering of concrete will not be permitted. Any concrete which has become so stiff that proper

placing cannot be assured shall be wasted. Formed concrete shall be placed in continuous approximately horizontal layers, the depths of which generally shall not exceed 500 mm. Concrete shall be vibrated (internal vibrators having a minimum frequency of 8,000 vibrations per minute) until it has been consolidated to the maximum practicable density, is free from rock pockets of coarse aggregate, and closes snugly against all surfaces of forms and embedded materials. Standby vibrators shall be available during concrete placement.

Exposed unformed surfaces of concrete shall be brought to uniform surfaces and worked with suitable tools to a reasonably smooth wood float or steel-trowel finish as directed. Concrete in the tops of foundations in which stub angles are embedded shall be sloped to provide drainage away from the stub angles.

(f) **Reinforcement**

Steel reinforcing bars shall be placed in the concrete were shown on the Drawings. Before reinforcement is placed, the surfaces shall be cleaned of heavy flaky rust, loose mill scale, dirt, grease, or other foreign substances. Reinforcement shall be accurately placed and secured in position so that it will not be displaced during the placing of concrete.

The Engineer shall not furnish supplemental bar-placing diagrams, bar lists, and bar-bending diagrams. Any such additional diagrams and bar lists of this type that the Contractor may require to facilitate the fabrication and placement of reinforcement shall be provided by the Contractor.

Reinforcement will be inspected for compliance with requirements as to size, shape, length, splicing, position, and amount after it has been placed.

Any bar-placing diagrams, bar lists, and bar-bending diagrams prepared by the Contractor shall conform to the requirements shown on the reinforcement design Drawings and shall be approved by the Engineer. Maximum two numbers (2+2) of bars in the pad and chimney can be lapped.

Lap splices shall be as under:

Bar#	3	4	5	6	7	8	9	10	11
Lap length (m)	305	360	460	610	840	1100	1400	1800	2160

(g) **Protection and Curing**

The Contractor shall protect all concrete against injury until final acceptance.

The concrete shall be cured with two applications (coats) at right angles to each other to ensure uniform and more complete coverage with approved bitumen emulsion protective coating to be applied as soon as possible after concrete placement/hardening. Curing with water shall be used only as an alternative and with Engineer approval. The application of the bitumen emulsion protective coating shall be following the procedures outlined by the manufacturer. In the case of pile-cap & tie beam with form, ties are loosened and vertical forms are still in place water should be applied to run

down on the inside of the form to keep the concrete wet. Immediately after form removal, the surfaces should be kept continuously wet by water spray or water-saturated fabric until the bitumen emulsion protective coating is applied.

In exceptional cases where extremely corrosive soil conditions are encountered, or as directed by the Engineer, the surfaces of the concrete, both exposed and unexposed, shall be treated with an approved type of bituminous compound. A minimum of two applications shall be required, and the applications shall be 100 percent effective. No extra payment will be made to the contractor for treating concrete surfaces with bituminous compounds.

(h) **Repair of Concrete**

Any concrete that is damaged or defective from any cause; concrete that is honey-combed, fractured, or otherwise defective, and concrete damaged because of excessive surface depressions, must be excavated and built up to bring the surfaces to the prescribed lines, shall be removed and replaced and any imperfections and irregularities on concrete surfaces shall be corrected. The removal and replacement of damaged or defective concrete, and the correction of surface imperfections and irregularities shall be made with concrete dry pack, or mortar (Portland cement mortar), or at the option of the Contractor, with epoxy-bonded concrete, or epoxy-bonded epoxy mortar, where and as applicable for the type of repair involved. All repairs should be completed within 24 hours after removal of forms, and as directed by the Engineer or his nominated person. However, forms shall not be removed for at least 24 hours after the concrete work until it has acquired sufficient strength to safely carry its weight and any construction loads that may be imposed on it.

(i) **Tolerances for Concrete Construction**

The Contractor shall be responsible for setting and maintaining concrete forms within the tolerance limits necessary to ensure that the completed Work will be within the tolerances specified or within good construction practices. Concrete work that exceeds the tolerance limits specified herein shall be inspected by the Engineer and he will determine what effect the deviations will have upon the structural action or operational function of the structure, and what remedies may be necessary. If after such inspection the Contractor is directed to remove or replace any defective Work, he will do so at his own expense.

(i) Tolerances for footings:

-	Variation from plumb or specified batter for lines and surfaces of stem	In any length of 3.0 metres 13 mm Maximum for the entire length26 mm
-	Variation in cross-sectional dimensions of stems	Minus 7 mm Plus 26 mm

-	Variation from specified elevation for the top of concrete	Minus	13 mm
		Plus	13 mm
-	Variation of dimensions in plan	Minus	13 mm
		Plus	52 mm
-	Misplacement or eccentricity	2 percent of the footing width in the direction of misplacement but not more than 52 mm	
-	Reduction in thickness	by 5 percent of the specified thickness	
	(ii) Tolerance for placing reinforcing steel:		
-	Variation of protection covering:	with a cover of 64 mm or less 7 mm	
		with cover of more than 64 mm 13 mm	
-	Variation from indicated spacing	26 mm

(9) **Backfill for Tower Footings**

Backfill shall be placed about the tower footings to elevations indicated on the drawings or as directed. The material used for backfilling, the amount thereof, and the manner of depositing this material shall be approved by the Engineer. Where the excavated materials are insufficient in quantity or are not suitable, as determined by the Engineer nominated person, for use as backfill, the Contractor shall obtain suitable material from the borrower. No borrow pits shall be made within a 25-metre radius from the center of the tower. Backfill shall be placed about the tower footings as soon as practicable after removal of concrete forms, but not earlier than 8 hours from application of sealing compound or bitumen coating to concrete surfaces.

The excavated material not suitable for backfilling or above the backfilling requirement shall be spread evenly over or adjacent to the Site. The backfill adjacent to the footing stems shall be approximately 150 mm above the original ground and shall be graded and sloped uniformly away from the stems so that there is no pond at or around the footing.

In backfilling for concrete footings, the pad of the footing shall be covered with fine material of 300 mm thickness (after compaction) before any coarse material is deposited. Care shall be taken to avoid damage to the concrete when backfilling. The backfill material shall be clean and free from vegetation, pieces of timber, or other foreign matter. Suitable material for backfilling shall be a compatible granular material having a granularity within the following limits.

<u>Sieve</u>	<u>% Passing</u>
76 mm (3 in)	100
No. 200	0-15

(10) **Compacting Backfill**

Backfill shall be placed in horizontal layers which after compaction shall not be more than 150 mm thickness. Each layer shall be compacted by tamping machines or other mechanical means approved by the Engineer.

Backfill shall be moistened properly where required. When excavated material is so wet that it is not suitable for backfilling, it shall be spread and aerated until the proper moisture content is attained, at which time the material shall be used as backfill around tower footings. The backfill material shall not be placed until all forms and timber used for shoring or bracing have been removed unless otherwise permitted by the Engineer or his nominated person.

The Contractor shall submit, for laboratory testing and approval, representative samples of the materials proposed to be used as backfill. Based on laboratory test results the Engineer shall specify the degree of compaction to be obtained in the field, which shall not be less than 90% of the maximum dry density as obtained by ASTM D-1557.

Density shall be measured in the field according to ASTM D-1556 or ASTM D-2937 by the Contractor in the presence of a nominated person of the Engineer to determine compliance with the specified degree of compaction. The cost of all laboratory and field testing shall be borne by the Contractor.

(11) **Additional Foundations**

In case other foundations are required to be installed, which are of a different design than the specific types listed, the Contractor shall install these foundations as directed by the Engineer. All work performed will be following these Specifications. Payment for additional foundations will be made at the applicable unit prices provided in the Price Schedules for similar works.

(12) **Foundation Test (Not Required)**

The Contractor may be required to perform an uplift load test on any one footing for a double circuit suspension type tower. The Engineer will designate the location and type of footing to be tested. All methods, procedures, equipment, jigs, apparatus, etc., shall be subject to approval by the Engineer. No testing shall be commenced until 28 days after the final concreting nor until all backfill is placed and compacted as specified herein.

An uplift load shall be applied until a design value is reached or the footing fails. The rate of load application will be determined by the Engineer.

1.5. **PILE FOUNDATIONS**

(1) **General**

(a) **Description of Work**

The Work to be performed under these Specifications shall be carried out at the proposed site of towers after the field and laboratory test results confirmation. The Work includes, but is not limited to the following:

- (i) Construction of bored, cast-in-place reinforced concrete piles as shown in the Drawings.
- (ii) Complete borehole logs and record all operations performed during the investigations and the execution of the Work.

(b) **Location of Investigation Borehole and Piles**

- (i) The location of investigation boreholes and piles on the ground shall be established by the Contractor following the Drawings and from reference points to be provided by the Engineer. Establishing the investigation borehole and pile locations accurately in the field shall be the sole responsibility of the Contractor.
- (ii) The Contractor will provide the levels, survey, and ground elevations for each investigation borehole and pile location. The elevations will be given for permanent benchmarks in the vicinity of the Site.

(c) **Diameter and Length of Piles**

Bored, cast-in-place reinforced concrete piles shall be constructed having uniform diameters throughout the length as specified in the relevant drawings. Pile footings shall only be installed where the field and laboratory tests confirm the requirements. The final length of the piles shall also be confirmed after testing.

(d) **Drillers and Supervisory Staff**

The Contractor shall have at Site, at all times only qualified, experienced, orderly, and thoroughly competent persons including graduate engineers/geologists who shall conduct and supervise drilling operations and piles construction.

(2) **Execution of Piles**

(a) **General**

This clause covers all the work necessary for the execution of the bored, cast-in-place reinforced concrete piles namely:

- (i) Formation of ramp
- (ii) Drilling and stabilizing of boreholes for the piles.
- (iii) Placing of steel reinforcement.
- (iv) Mixing and placing of concrete.

The Contractor shall perform all such work following the requirements of this clause as well as following the methods as proposed by him and approved by the Engineer.

(b) **Method of Drilling**

The drilling of holes for piling shall be done by mud circulation or reverse rotary or percussion method or any other method suggested by the Contractor and approved by the Engineer. Regardless of the method used for drilling holes, drilling operations shall be carried out in such a way as to avoid any disturbance of the surrounding soil especially at the bottom of the hole and successful drilling through all types of soil/rock/boulders.

(c) **Stabilizing of Holes**

There will be no permanent casing installed. Any temporary protective casing at the start of the drilling shall be later pulled out. The stabilizing of the drilled holes shall be achieved by using natural or commercial drilling mud/bentonite. Permanent casing shall only be allowed with the prior approval of the Engineer.

(d) **Tolerances**

Tolerances for setting out and for concrete construction shall conform to Clause 9.4 of these Technical Provisions. In the case of piles, deviation from the vertical shall not exceed one (01) per cent on any section of the length of the holes.

(e) **Concrete**

All concrete and reinforcement placed in the construction of piles shall conform to the requirements of Clause 9.4(8) of these Technical Provisions. In addition to this, the following requirements shall also be fulfilled.

- (i) Promptly after cleaning the hole to the entire satisfaction of the Engineer Representative, concrete shall be placed in a manner that will not cause segregation of the particles or permit infiltration of water or any other occurrence which would tend to decrease the strength of the concrete or the capacity of the finished pile. The slump shall be limited to 150mm minimum and 175mm maximum.
- (ii) The minimum clear distance between vertical reinforcement, including lapped bars, shall be 100mm (if applicable).
- (iii) Either tremied or pumped-in concrete can be used in the presence of water or drilling mud. Tremie or pump pipe shall be made of steel and have watertight joints. Tremie pipe shall have a minimum diameter of 8 inches, and pump pipe shall have a minimum diameter of 4 inches should be used. Embed tremie or pump pipe a minimum of 3 meters in the concrete throughout concreting. The method and equipment used shall be subject to the prior approval of the Engineer.

- (iv) Concrete placement shall proceed without interruption until the pile is complete.
- (v) Vibrate the top 3 to 4 meters of concrete after the temporary casing has been withdrawn.
- (vi) The Contractor shall make three test cylinders per pile or as directed by the Engineer during the concreting of piles.
- (vii) The vertical bars of the pile can be coupled together as directed by the Engineer according to the site requirement.
- (viii) The inner dia of the stand casing/permanent casing should be at least 25mm larger than the pile dia, whereas the bit dia should be equal to the pile design dia.

(f) **Record**

The Contractor shall keep accurate logs and records of all the Work accomplished under this Contract. All such records shall be preserved in good condition by the Contractor until they are delivered and accepted by the Engineer. The Engineer shall have the right to examine such records at any time before their delivery to him. The following information shall be included in the records for each pile.

- A general description of sub-soil conditions and water table position at the location of the pile.
- Pile number, the ground elevation of the borehole, and elevation of the top of the pile.
- Type of drilling operations.
- Date and time by depths when drilling operations were performed and piles constructed.
- Total depth of each borehole.
- Quantity of concrete and steel used for the construction of each pile.
- Quantity of constituents for each batch of mix, water-cement ratio, and the results of all quality control tests.
- Time of start and completion of Concrete.
- Remarks concerning any unusual occurrence during drilling and concreting of piles.

1.5.1 Tower Erection

(1) General

The contractor's work includes the supply of manpower, providing construction equipment, vehicles, and rigging tackles for the complete assembly of towers.

Erection shall be done strictly following the approved Contractor's drawings, material lists, and approved construction data sheets.

No tower shall be erected **until seven days after the last concrete** was placed in the foundation, nor until the backfill has been completed where and as required.

The Contractor shall follow the procedures laid down in the IEEE Guide for the Assembly and Erection of Metal Transmission Structures (Latest Edition) and mentioned herein below.

(2) Handling

Tower steel shall be handled to prevent deformation of the members and damage to the galvanizing. Materials shall not be dumped, dragged, barred; rolled, or dropped but shall be carefully loaded, unloaded, and stored. A mechanical means such as a hoist or crane shall be used when material cannot be properly handled or placed by hand.

Bare wire rope or steel chains shall not be used for handling without adequate protection of the surface coating. Heavy members shall not be stacked on top of lighter members. Structural members shall be stored according to size, length, and markings. The maximum weight of steel bundles shall not exceed a specified weight, typically 1600 kg to 1800 kg, to facilitate handling and unloading. Members with dissimilar finishes shall not be stored over one another to minimize discoloration of the lower members.

All members shall be placed on wood blocking or other suitable material to ensure that the materials to be stored are not in contact with the ground. Blocking shall also be used to separate layers of stacked materials. Members shall be supported in such a manner as to prevent bending and distortion as well as to allow water to drain from the materials.

Failure to provide for proper drainage of stacked galvanized steel members could result in the formation of white rust. White rust (zinc oxide) forms when two galvanized surfaces are closely rested for an extended time without adequate ventilation. Ingress of water between the surfaces forms an electrolytic cell, which may, in time, erode some of the zinc layer. The white rusting action will stop after exposure to air. Spacers placed between the nested pieces ensure adequate ventilation when extended transport storage is anticipated.

The material yard shall be kept relatively neat and clean and the growth of vegetation kept to a minimum. Good housekeeping minimizes damage and loss of material handling; periodic physical inventories and complies with environmental considerations.

(3) Assembly Methods

All assembly and erection shall be done by methods and equipment that will not cause damage to, or distort any part of the tower. Extreme care shall be taken to establish and maintain the true geometric shape of the sections of the tower assembled.

Preassembly techniques are generally influenced by site terrain and available equipment. Generally, the larger the section that can be pre-assembled, the more efficient the assembly/erection operation. Preassembly techniques shall consider the placement of the assembled sections to provide for the most efficient, safe lifting for erection. Structural assemblies, which are not sufficiently rigid to be raised in one piece, shall be stiffened using adequate temporary bracings.

Towers assembled on the ground shall be placed on suitable blocking to be kept free of dirt, mud, or other foreign material that might adhere to the structure and damage the coating. Blocking shall be placed in such a manner as to provide a flat surface to prevent overstressing or distortion of members and to maintain the true geometric shape of the assembled members. Mud, dirt, white rust, and other foreign material shall be removed from the contact surfaces of joints before assembly. Steel members shall not be dragged over the ground or otherwise handled in such a manner as to damage the galvanizing.

The structures shall be assembled following the fabricator's erection and detail drawings. The diameter, type, and length of bolts as shown on these drawings shall be used for each connection. Orientation of bolts can facilitate access, final tightening, and installation of locking devices and subsequent checking of the erected structure. Tower bolts shall normally be installed so that the nuts are to the outside of the tower or, in the case of horizontal members, to the top of the connection unless such positioning is impracticable.

Installation of bolts by hammering or any method that damages the galvanized coating shall not be allowed.

When sections of towers are being assembled before erection, assembly shall be on blocks that will provide support, sufficient to prevent distortion of tower steel. If all bolts in an assembly are not inserted, at least 50 per cent of the bolts in each connection shall be inserted and those bolts shall be finger-tightened only. All bolts in an assembly shall be inserted before any bolt in the assembly is fully tightened.

Only wrenches that properly fit the nuts and bolt heads shall be used, it will be preferable to use hydraulic torque wrenches for bolt tightening. The use of wrenches, which in any way deform the nut or cut or flake the galvanizing is prohibited. All bolts shall be entered clear to the head. All 16 mm diameter bolts shall be tightened to a torque of 10-14 kg-meters and 20 mm and 24 mm diameter bolts to a torque of 17-23 kg-meters. All bolts after torque shall be center punched adjacent to the nut to prevent loosening of the nut. This method of locking the nuts will be used instead of locknuts.

(4) Method for Erection

Towers shall be erected by any suitable method in the sequence best adapted to the equipment, workers' experience, and site conditions which will not overstress structure members.

When handling assembled portions of the structure, spreader bars, or other devices with proper points of attachment shall be used to avoid distorting or overstressing members and maintaining the true geometric shape of the section.

Adequate tag lines shall be used to ensure that no section of the tower being lifted will drag on the ground or against any section of the tower already erected.

Temporary guying may be required when erecting a structure in sections. Any temporary guying system shall be checked to ensure that the structure section is stable before workers are allowed to work on the section.

Structures shall be completely erected, and correctly oriented, with all members in place, all bolts installed and properly tightened, and the entire structure checked following the specifications before the installation of insulators, conductors, and OPGW.

When erecting structure members or sections in the vicinity of energized lines, care shall be taken to ground these members or sections before any workers come in contact with them.

The use of a crane erection is generally an efficient method of erecting latticed steel structures. With ground pre-assembly of sections, the time spent in final erection can be greatly reduced.

Cranes with telescoping booms can be more efficient than rigid boom cranes in rough terrain. Considerable productivity can be lost in the process of assembly and disassembly of rigid boom cranes. In addition, continuous handling of boom sections can lead to boom damage. Preplanning of the crane location at the structure site allows for any necessary grading work (building of ramps, soil stabilization, etc.) to be accomplished during the foundation construction operations when suitable equipment is available at the site. Depending on soil conditions, additional bearing support may be required under outriggers, tracks, and tires. All soil shall be returned to a condition acceptable to the Engineer after erection.

A Gin Pole is a boom of steel or aluminum pipe, wood pole, or latticed truss secured at its base and usually inclined at a slight angle to the vertical is also used for tower erection. Two wire-guys about 60° to 90° apart in the plan view are attached to the top of the gin pole to resist or support the load to be lifted. For safety, a third, and preferably a fourth guy, is installed in front to prevent the pole from falling over backwards in the event of an unexpected impact or the sudden release of load.

(5) **Correction of Mis Fabricated and Damaged Steel**

All shop errors and damaged steel shall be reported to the Engineer who will decide how corrections shall be made. All costs incurred due to punching, drilling, or cutting shall be deemed to be included in the steel erection cost.

Pieces bent in handling may be used if they can be straightened to the satisfaction of the Engineer, without structurally damaging the metal. If bent pieces cannot be satisfactorily repaired, they shall be replaced.

Field punching or drilling of holes and field clipping shall be done only with the approval of the Engineer if the hole or clip was missed in the fabrication of the member but was called for on the fabrication detail drawings. The edges of clipped angles, new or reamed holes, or any member which has its coating scratched or damaged shall be repaired with a coating approved by the Engineer. Members having mis-punched holes shall not be repaired by welding and shall be replaced with correctly fabricated members. If the field fabrication of a member is required, the bolt spacing and edge distances shall follow the fabrication detail drawings.

Reaming shall be done only with the approval of the Engineer and will be permitted, for the correction of undersized holes, for removing excessive galvanizing, and for holes off gauge line, to the extent that the connection cannot be made by loosening bolts in related connections. No hole shall be reamed more than one-eighth of its original diameter.

Reaming to remove fitting difficulty due to improperly set footings, to correct improper tower assembly and erection, that would distort holes or distort any member, or that would damage the galvanizing, is prohibited.

(6) Damage to Galvanizing

Small areas of galvanizing damaged by abrasion, in straightening bent pieces or by necessary clipping in the field, shall be repaired by carefully cleaning the affected area and painting. The paint will be furnished by the Contractor.

The damaged area shall be wiped with clean rags saturated with Xylene or equivalent solvent, followed by wire brushing then re-cleaned with solvent to remove residue, and painted with one coat of "Galvanox", or approved equivalent.

Galvanizing damaged by drilling or punching shall be repaired by applying an Aluminum paste or zinc-rich coating material to fill all voids between the bolt and the surfaces bared or all exposed steel surfaces around the holes or on cuts on which such corrective work is permitted. The coating material shall be "Galvanox" or the approved equivalent.

(7) Tower Signs and Aerial Markers

a) Material

All the plates i.e., danger sign, number & phase plates, and aerial markers shall be baked ceramic surfaces on high-grade steel base plates of a minimum thickness of 1.5 mm except the aerial marker plate which shall be of 3.0 mm thickness. The fabrication details and dimensions of the plates are shown on the Specifications Drawings.

The plates shall be painted with ceramic paint on both sides and shall be thoroughly cleaned before painting and the ceramic paint shall completely cover the front and back of the plates and also the edges of plates and the

interior edges of the attachment holes. The ceramic paint shall be of even thickness, reasonably free from cracks, patches, pinholes, and blisters, and shall have a uniform gloss. The ceramic paint around the holes shall be protected using fiber washers.

Three coats of ceramic paint shall be applied to the danger sign and number plates. The first coating of black ceramic paint shall be applied on both sides of the plates. The other two coats of white ceramic paint shall be applied on the front side of the danger & number plates and yellow on aerial marker plates.

In the case of phase plates, three coats of ceramic paint shall be applied. The first coat of black ceramic paint shall be applied on both sides. The other two coats of red, yellow, and blue colour shall be applied as specified on both sides of the plate.

Nos. of bolts, nuts, washers, and fixtures where required shall be supplied with each plate as shown in the drawings. Bolts, nuts, and washers to be supplied with the fixture shall be galvanized following ASTM A153.

b) Acceptance Tests

The following acceptance tests for Sign & Number Plates and Aerial Markers shall be carried out:

- (i) Visual examination
- (ii) Verification of dimensions
- (iii) Galvanizing test (on fixture and nuts & bolts only)
- (iv) Resistance to thermal shock (vitreous enamel finish)

(i) Visual Examination:

<u>Examination</u>	<u>Defects</u>
a. Construction	Not of the shape given in relevant Drawing. Any crack on the nut& bolt.
b. Material	Not of proper material.
c. Finish	Galvanizing of bolts, nuts, washers, and fixtures not proper, presence of black spots, blisters, flux, dress, un-coated areas, or any other defects. Bolts and nuts, rusty. Threads marred. The plates are not properly enameled and presence of cracks, patches, pin-holes, blisters, or any other defect. Letters and numbers are broken or not properly enameled.
d. Marking	Missing or incomplete or not as per drawing.

(ii) Verification of Dimensions:

Dimensions of the danger, number, aerial markers, phase plates and fixtures shall conform to those given in the Specifications Drawings with allowable tolerances as marked on the individual drawings. Any variation from the specified dimensions shall constitute a defect.

(iii) Galvanizing Test:

The galvanizing of the nuts, bolts, washers and fixtures shall be tested following ASTM Specifications.

(iv) Resistance to Thermal Shock:

This test shall be carried out by subjecting the test specimen to radiant heat to reach a steady temperature of 185-195°C in about ten minutes. The temperature shall be measured using a surface pyrometer in contact with the top surface of the heated part of the specimen.

Remove the radiant heat and within 5 seconds quench the surface with 1000 ml of water at 15-20°C direct from an aspirator or other container through a 5 mm diameter tube, the end of the tube is 150 mm above the center of the heated portion of the test specimen. The flow rate of water shall be adjusted to 10 ml per second. It is convenient to mark the test area to ensure that the water is correctly applied. Dry the plate, replace it in the same position under a radiant heat source and repeat this procedure until six cycles have been completed.

After subjecting the test specimen to the above test, the vitreous enamel surface shall be considered to be resistant to thermal shock provided that the enamel shows no signs of flaking-off or crazing.

Sampling, Acceptance and Rejection:

Danger, number, phase plates, aerial markers and fixtures offered for acceptance shall be divided into lots containing up to 200 units in each lot. A sample of 12 units (3 each from danger, number, phase and aerial marker) shall be drawn at random from each lot. For the thermal shock test, two samples each shall be randomly selected from the offered lot.

The selected samples shall be subjected to the visual examination, verification of dimensions and galvanizing. If the number of defective units is two, the lot shall be accepted. If the number of defective units is more than two the lot shall be rejected. If the number of defective units is three, another sample of 12 units shall be selected at random and subjected to tests. If the number of defective units is three or more then the lot shall be rejected and if the number of defective units is less than three then the lot shall be accepted.

c) Installation

Tower signs (danger and number signs) shall normally be installed on the tower so that they will be readily visible when viewed in the direction of increasing tower numbers. However, if signs installed in the normal position will not be readily visible from a permanent access road, they shall be installed on the tower faces best exposed to view from the access roads. These signs shall be supplied by the Contractor, and before the manufacturing, a sample shall be submitted to the Engineer for approval.

Aerial markers shall be installed on the upper side of the bridge structure, as shown on the drawings. Two markers shall be installed on every tenth tower of the line; one marker faced back on line and the other ahead online. These shall also be supplied by the Contractor.

(8) Anti-climbing Devices

a) Material

Material, dimensions, and testing of the barbed wire shall be following ASTM A121.

The size and characteristics of the zinc-coated barbed wire shall be as per design number 12-2-4-14R, Type Z with Class 3 coating.

The material of structural steel of anti-climbing devices shall be a maximum of mild steel as per ASTM A36 and galvanization according to ASTM A153.

b) Acceptance Tests

The following acceptance tests for barbed wire shall be carried out:

- (i) Visual examination
- (ii) Verification of dimensions
- (iii) Galvanizing
- (iv) Physical
- (v) Mechanical

These tests shall be carried out on the selected samples as per the test procedure defined in the relevant ASTM specification.

c) Installation

An anti-climbing device will be installed on each tower as shown on the relevant drawings. The anti-climbing device normally will not be installed until all the tower and wire stringing work is completed.

The tower steel will be provided with holes for mounting the anti-climbing device brackets. The brackets shall be fabricated from mild steel and shall be galvanized following ASTM A153. The brackets along with barbed wire shall be supplied by the Contractor. Any holes required to be punched/drilled for installation of Anti-climbing Devices and application of Galvanox shall be carried out by the Contractor without any extra cost.

Anti-climbing devices will be provided with an arrangement of barbed wire around the tower to prevent unauthorized person(s) from climbing the tower.

After erection, the tower shall be cleaned of any foreign matter.

(9) Supporting Device for Joint Boxes of OPGW

Supporting devices for joint boxes of OPGW to be designed, manufactured, and supplied by OPGW Contractor will be installed on the towers where joint boxes are required to be installed. Joint boxes will be installed on the tower on completion or just before completion of each OPGW reel of about 3.2 km length or wherever particularly required. The holes required to be drilled in the tower braces for installation of these supporting devices including the provision and application of Galvanox at the holes drilled shall be the responsibility and the cost of the Contractor.

(10) **Welding of Nuts & Bolts**

All nut & bolt connections of all types of towers shall be welded according to Specification Drawings, up to 8.0 m height from the top of the chimney. After welding, cold galvanized paint (zinc rich paint) having at least 90% zinc content shall be applied to the welded portion. At least two coats of the paint shall be applied. The cost of welding including application of paint shall be deemed to be included in the unit rate/tower quoted.

1.6 Installation of Insulators and Hardware

Insulators and insulator hardware shall be assembled and installed as shown on the drawings and following the recommendations of the Contractors.

The Contractor shall follow the procedures laid down for the installation of Insulators and Hardware in the IEEE Guide for the Assembly and Erection of Metal Transmission Structures (Latest Edition) and mentioned herein below.

No insulator with chips or cracks in the glass or defects in the fittings shall be installed.

Uncrated or otherwise unsupported strings of insulators shall not be picked up or suspended except by the upper units of the string. All cotter pins installed by the Contractor shall be checked.

All insulators shall be cleaned with a clean cloth when installed. The glass shall be bright and all other parts free from dirt. Only clean rags free from any abrasive material shall be used for cleaning insulators.

Wire brushes shall not be used for the cleaning of any parts, metal or otherwise. The use of solvents will not be permitted.

Each completed suspension assembly shall be adjusted to hang in a vertical plane through the axis of the tower. Where it would be possible, nuts, locknuts, and cotter pins shall be placed to face the tower body.

Workmen shall not climb on insulators during conductor-pulling operations.

When raising conductor strain assemblies, the insulators shall be kept under tension to avoid the possibility of those being damaged due to excessive bending.

1.7 Stringing Conductors and OPGW

(1) **General**

The conductor and OPGW shall be installed as shown on the drawings and as specified herein.

The Contractor shall follow the procedures laid down in the IEEE Guide for the Assembly and Erection of Metal Transmission Structures (Latest Edition) and mentioned herein below.

(2) Safety Grounding

It shall be the Contractor's responsibility to take adequate safety precautions to protect his employees and others from the potential voltage build-up during construction. The voltage build-up may be comparatively small during normal operations but could be lethal during switching and ground fault conditions on the energized parallel line. The following minimum safety and grounding procedures shall be followed by the Contractor during stringing operations in the Sections with parallel existing high-voltage lines.

Temporary electrical grounds shall be placed at both ends of the section requiring special safety precautions and at intervals along the line which is under construction. The grounding sets installed at both ends of the section of the line shall remain in place until the completion of the work and shall be removed as the last phase of the cleanup. Hot sticks shall be used for installing and removing the grounding sets.

All temporary grounds furnished and installed for protection shall be visible for inspection and shall be flagged by the use of a red cloth placed at the point of grounding. All grounds, except those placed at both ends of the section, and red flags shall be removed when they are no longer needed for protection.

All pulling and tensioning equipment shall be bonded and effectively grounded with approved-type driven grounds securely attached to the equipment. At least two driven grounds shall be used at both the pulling and tensioning set-up. All conductive parts of the tensioning set-up and equipment shall be operated from a grounded or insulated platform provided with barricades or insulated walkways.

Running grounds shall be installed within 6 meters of the tensioning set up to constantly ground each sub-conductor and OPGW. At the pulling set-up, grounding shall be achieved by the use of block grounds connected to the adjacent tower by approved-type ground leads bonded to the tower with approved-type clamps. These connections shall be removed by the use of a hot stick.

An approved-type driven ground shall be located at each side and within 3 meters of working areas where conductors or OPGW are being compressed to dead-end assemblies or spliced at ground level or jointed. The two ends to be spliced shall be effectively bonded together before and during the splicing operation. Splicing and compression operations at dead-end assemblies shall be carried out on either an insulated platform or on a conductive metallic grounding mat roped off with an insulated walkway provided for access to the mat.

Installation and removal of temporary jumpers, at any time the conductor is not continuous, shall be performed by hot stick methods.

All conductors and OPGW shall be bonded to the tower with approved-type tower grounds at any isolated tower where it may be necessary to complete the Work. Work on dead-end towers shall require grounding on both sides of the tower. Grounds may be removed when the Work is completed, providing the line is not left open-circuited at an isolated tower at which work is being completed.

For all sections of the line under work, which are not in parallel with energized high voltage lines or otherwise requiring special safety precautions, only the provision of the grounding at the pulling and tensioning stations shall be required.

All provisions specified herein shall not prevent the Contractor from installing as many additional grounds as deemed necessary for the protection of workmen against static and accidental contacts with foreign circuits.

Clipping crews and all others working on the conductive pulling lines, isolated conductors or OPGW shall be protected by individual hot stick clamp-type grounds installed at every work location.

(3) **Approved Type Grounding Material**

Approved type moving grounds shall be such as to exert constant pressure on the conductor or OPGW, and the contact rollers shall be with permanently lubricated-type bearings.

Approved-type driven ground rods shall be a minimum of 16 mm diameter copper weld or equivalent. Ground rods shall be driven into the ground a minimum of 2.5 meters.

Approved-type tower grounds shall be hot stick clamp grounds, bonded to the tower with a flexible ground lead.

Approved-type ground leads shall be at least 43 mm² cross-section copper or equivalent.

Approved-type insulated platforms shall be constructed of 65 mm nominal dimension lumber supported on 102 mm nominal dimension sills, or of materials of equivalent insulation.

At the tensioning set-up, the insulated platform and rope barriers shall extend completely around the equipment set up in such a manner as to prevent anyone standing on the ground from contacting any conductive part of the equipment.

(4) **General Safety Precautions**

Before initiation of the stringing in any section of the line, the following shall be ensured.

- (a) The installation of all towers within the section of the line is satisfactorily completed.
- (b) The stringing loads will not exceed the design loads for any of the towers.

- (c) If any tower is to be subjected to loads exceeding the design loads, the Contractor shall provide temporary bracing for such tower, and the bracing is subject to approval by the Engineer.
- (d) The stringing and sagging operation is such that no sudden loads will be applied to the towers.

(5) Safety Precautions at Crossings

Wherever any power line, communication line, highway, or a railroad is to be crossed, the owners shall be notified 30 days in advance and all temporary changes shall be pre-arranged.

The Contractor shall not erect towers near, or string conductors or OPGW over energized power circuits until a Hot-Line Order is placed on the energized line.

Qualified personnel shall remain at the site of work while the Hot-Line Order is in effect and shall ascertain that all personnel are clear and properly notified before the Hot-Line Order is released.

All existing lines which are de-energized for crossing shall be short-circuited and grounded at each side of the crossing.

Guard structures shall be provided at all crossings, as required for the protection of the conductor, line, road, structure, or feature being crossed, and as required by the owner, or the Employer.

Guard structures shall be of sufficient strength and stability to withstand the stresses to which they may be subjected.

As soon as a guard structure has served its purpose, it shall be removed and all holes shall be backfilled.

(6) Atmospheric Adverse Conditions

All pulling and stringing operations shall cease when either wind velocities are such as to cause conductors to deflect more than 1.5 meters at mid-span from the normal no wind position or there is any indication of lightning activity in the area.

(7) Handling and Stringing of Conductors

The conductor will be furnished in matched sets of twenty-four (24) reels and shall be strung by the controlled tension method. At no time the conductor will be allowed to contact the ground or any object which might cause damage to the conductor.

All reels shall be inspected in the field before installation. Reels showing signs of careless or unusually rough handling, such as split frames or crashed outer protective lagging shall be inspected carefully for conductor damage.

Preparatory to un-reeling a conductor from the reel, the outer protective lagging shall be removed carefully, and all surfaces in contact with the running conductor shall be examined for protruding objects which might damage the conductor.

Care shall be taken to ensure that no dirt is carried by the conductors from the reels. Reels shall be properly cleaned before starting the stringing operation of any line section.

A spreader bar shall be used when lifting or lowering the reels. Full or partial reels shall not be dropped or rolled under any circumstances.

The four conductors in a bundle shall be strung simultaneously and shall hang in stringing blocks for the same period not exceeding 24 hours and, in exceptional cases, up to 48 hours before being sagged to the specified sag.

Four conductors shall start and end approximately at the same points of the line and stringing operations shall be planned to keep waste to a minimum. Lengths of conductors less than 100 meters are scrap lengths and shall not be spliced into the line without the approval of the Engineer. Jumpers shall be cut only from scrap lengths unless otherwise permitted.

Stringing sheaves may be hung on the insulator strings or in straps of equal length attached to the structure arms with suitable hooks or clamps. The sheave shall support the conductors at the same elevation as when clipped in.

Uplift rollers that attach to the traveler or hold-down blocks that are separate devices must be used at positions where uplift might occur. Uplift can occur with the pulling line during the stringing operation, due to its higher tension-to-weight ratio and, thus, much flatter sag. This condition is most likely to occur in hilly terrain at the towers in the low points of the pull. Hold-down blocks or uplift rollers should be used in these cases. Since the uplift condition will normally stop when the conductor(s) arrive, hold-down blocks that can be removed before the arrival of the conductor(s) without stopping the pulling should be used. Uplift devices that attach to bundle travelers are usually directional and are usually positioned toward the pulling end. These devices should have a breakaway feature in the event of fouling of the pulling line or incorrect installation.

Where travelers are installed to string through dead-end towers, the travelers are normally connected directly to the tower. If line angles of more than 20° are involved, then two travelers in tandem may be required to reduce the bending radius of the conductor or the load on each traveler, or both. Where bundled conductor travelers are used at line angle locations of over 5°, it is advisable to change to individual single conductor travelers after the passage of the running board to facilitate accurate sagging.

Stringing of conductors and temporary guying of conductors shall be done by methods that will prevent damage to the conductor and structures in any way. Temporary guying/dead endings to tower footings will not be permitted. Where a temporary dead end is required, the conductors shall be attached to suitable temporary anchors.

The general requirements for the installation of the temporary anchors are as follows:

The angle formed by conductors / OPGW to the horizontal shall not exceed 15 degrees.

The anchors shall be aligned in the direction of stringing:

The anchors and their accessories shall withstand the maximum conductor tensions with a factor of safety of three.

Four sub-conductors of one phase shall be strung simultaneously using a running board attached to a single pulling line with a swivel. Sub-conductors shall be connected to the running boards with a swivel connection and a stocking-type grip. The grips shall be secured to the conductor using a band installed around the tail end of the grip.

Following stringing, measures shall be taken to prevent the sub-conductors of the bundle from contacting each other. Before adjusting the sag of the conductors, sub-conductor slapping may be prevented by pulling each of them to a different sag which will separate them at least 153 mm vertically from either of the other sub-conductors at mid-span. After adjusting the sag, the following conditions will require sub-conductors tie-off: any time that sub-conductors slapping is noted, any time before spacer installation, the conductors are left unattended.

Two-reel lengths of the conductor may be pulled into the sheaves using only approved swivels and grips to make the connections between reel lengths. Double socking will be permitted, but permanent splices shall not be pulled through a sheave or bull wheel without the use of rigid steel casing/cover suitable to prevent bending of compressed splices/mid-span Joints while crossing the sheaves or bull wheels/Travelers.

All sheaves, swivels, and grips shall be inspected daily for free and easy movements and to assure that such may be safely used. Sheaves carrying pulling lines shall not be used for conductors.

The conductor shall be kept clean by removing grease, dust, or any other contamination. Cleaning shall be done immediately after the conductors leave the tensioning device. The method of cleaning shall be wiped with a clean cloth saturated with the proper cleaning agent. When it is necessary to slack the conductor at any time during the stringing operation, it shall be done with the approval of the Engineer. Rigid plank guard or lagging, or a combination of both shall be used to prevent damage. Lagging shall consist of nonmetallic material which will not damage the conductor and shall be rigid so that it will not be displaced by the motion of the conductor. It shall be free of any material, which can be transferred to the conductor.

Sections of the conductor damaged by the application of gripping attachments or any other way during stringing shall be removed before the conductor is sagged in place.

The conductor repairs shall be done as outlined in Clause 1.7(11) (b) of the Technical Provisions.

All stringing operations must be conducted so that at no time will any suspension structure be subjected to longitudinal loads and at no time will any tension structure except the dead-end structure be subjected to excessive unbalanced loads resulting from longitudinal loads on opposing faces. At no time shall any

structure be subjected to torsion. The vertical angles of pulling lines shall be such as to minimize the vertical loading on towers. The attachment of temporary guys and stringing equipment on towers shall be done only with the approval of the Engineer.

The conductor reels, tensioners, and pulling machines shall be located as near to mid-span as possible but in no case shall the slope of the OPGW or conductor between any machine and the stringing block or any anchor lead be steeper than three horizontals to one vertical (15° - 20° to the horizontal).

The tension in the conductor during stringing shall be maintained as constant as practicable. The sag in each conductor must be maintained at least 20 percent greater than the sagging value specified in sag charts and the maximum pulling tension shall never exceed the sagging tensions.

If the conductor is left unattended, during stringing operations, it shall be freely suspended between stringing sheaves to provide a safe clear distance over ground or obstructions.

The minimum tension shall be such as to maintain the conductors at a minimum distance of 3 meters above ground or any obstacle.

When there is the possibility of the conductor being damaged due to wind or other conditions, it shall immediately be fully tensioned. It is recommended that variations in stringing tensions be as small as possible and the tension shall be near the maximum permitted. Immediately after completing the stringing of a section of the line, the tensions shall be increased to the maximum permitted stringing values.

The spinning of the conductors and OPGW shall be prevented during stringing. Unreeling of the conductors shall be closely watched at all times to detect any damage or flaw in the conductor.

(8) **Handling and Stringing of OPGW**

One OPGW shall be strung for the entire length of the line.

The specifications used for handling and stringing the OPGW shall be the same as for the conductors.

(9) **Conductor Sagging**

After being pulled into the sheaves all sub-conductors in a sag section shall be sagged within 24 hours.

The conductors shall be sagged following sag charts, furnished by the Contractor. The exact value of sag for a given span length at a given temperature can be ascertained from the appropriate table or by linear interpolation of data.

Conductor sagging temperature shall be measured by an accurate thermometer. A length of the core shall be pulled from a 0.5-meter length of the conductor sufficient for the thermometer to be inserted into the space vacated by the core.

The length of conductor shall be placed in the full sun at least 4 meters above the ground for a minimum period of 15 minutes. A thermometer in a container that stimulates the effect of the conductor may also be used.

The length of the conductor sagged in one operation shall be limited to the length that can be sagged satisfactorily, usually 2,300 meters to 4,600 meters.

Temporary snubs shall be used between a section previously sagged and clipped in and the section being sagged. Dead endings or snubbing will not be permitted on any tower except dead-end towers at the normal point of attachment.

When conductors are sagged a mark shall be placed on each conductor at the last structure in each pull. The location of this mark shall be checked after the succeeding sag has been made to ascertain whether or not the back spans are still sagged properly. The wire grips may be removed only after the next section of the line has been sagged.

When a sagging conductor has lengths of more than four spans, the sag shall be checked near each end span and at or near the middle span of the length being sagged. The length of the spans used for checking sag shall be nearly equal to the ruling span as practicable.

The sag of each span more than 600 meters in length shall be checked in addition to the above. Sag at sharp vertical angles and horizontal angles of 10 or more degrees shall also be checked on both sides of the angle.

The sags shall be determined using transit or other approved methods. At least one person shall be provided to measure the correct sag for pulls up to five spans, two persons for six to ten spans, and three persons for eleven spans or more.

The total number of spans to be checked shall be not less than two in a four-span section, three for a section up to two kilometres, and in proportion for a longer section.

In the quad conductor bundle the sag of the two upper sub-conductors shall be the same. The lower sub-conductors shall be sagged from 30 to 60 mm more than the upper sub-conductors.

A tolerance of plus or minus 10 mm of sag per 30 meters of horizontal span length, but not to exceed 150 mm in any one span, will be permitted, provided that: (1) upper sub-conductors in the span assume the same sag; (2) the necessary ground clearance is obtained; (3) the conductor tension between successive sagging operations is equalized so that the suspension insulator assemblies will assume the proper position when the conductor is clipped in; (4) the sag in the lower sub-conductor of the bundle is 30 to 60 mm more than the sag in the upper sub-conductors.

Log books shall be maintained to record all conductor installation data and chronological progress.

The temperature, spans, tower, general weather, wind velocity and direction, sags, tensions, and drawing references shall be recorded for each section of the

conductor as it is being installed, tensioned, and sagged. When possible, sagging operations shall be scheduled when wind velocity is at or near zero.

Radio, telephone or mobile communication shall be used to relay information and instructions between the conductor payout station, intermediate checkpoints, mobile stations and the pulling stations at all times during stringing operations. A failure of communication requires immediate cessation of the conductor pulling operation.

(10) Conductor Clipping-in

After being sagged, the conductor shall be allowed to hang in the stringing blocks for not less than 2 hours before clipping-in is commenced, to permit the conductor tension to equalize.

Plumb marks shall be made on the conductors in the vertical plane through the centerline of the tower before clipping in. Only paint, crayon, or wax pencil shall be used for marks on conductors.

All conductors marking in the section being sagged shall be accomplished while the conductors are in the sheaves and before clipping-in or dead-ending is begun.

The total time during which the conductor is allowed to remain in the stringing blocks before being clipped in shall not exceed 72 hours.

Torque wrenches shall be used to tighten all nuts on clamps. The torque applied shall be in conformance with the recommendation of the Contractor.

Yoke plates for V- V-string insulators shall be installed as shown on the drawings and shall hang at 90 degrees to the conductor axis within a tolerance of plus or minus 2.5 cm.

Well-padded pull-lift hooks or other approved methods shall be used for handling conductors during the clipping-in operation.

(11) Installation of Conductor and OPGW Accessories

(a) Splices and Dead Ends

All splices shall be of the compression type.

All splices shall be made at least 15 meters away from structures and no splices shall be made in dead-end spans or spans greater than 600 meters or spans crossing over the highways, railroads, major canals, rivers, and transmission lines of voltages greater than 33 kV unless approved by the Engineer.

As a rule, not more than one joint or splice should be made in any one conductor in any one span. However, in exceptional cases, as in the repair of damaged conductors, or when necessary, owing to stringing limitations two splices will be allowed.

The splices and compression dead ends shall be installed following the recommendations of the Manufacturer of the accessories.

The conductor shall be laid out straight for a distance of 15 meters and straightened at the end before preparation of the ends for splicing or dead-ending. The ends of the conductor shall be thoroughly cleaned immediately before compressing. After the compression has been completed, all corners, sharp projections, and indentations shall be carefully rounded and smoothed, and tape, tape residue, and filler paste shall be removed from the splice and conductor. If the completed splice requires straightening, it shall be straightened on a wood block by use of a wooden maul.

Splicing, dead-ending, and repair of damaged conductor shall be done in the presence of the nominated person of the Engineer.

If the completed splice or dead-end is not satisfactory, in the opinion of the Engineer or his nominated person, it shall be removed and a new splice or dead-end shall be properly installed.

The Contractor's inspector shall stamp his initials on the aluminium sleeve of each compression joint and compression dead end completed under his supervision.

(b) Repair of Conductors

Damage is any deformity on the surface of the conductor which can be detected by eye or by feel and shall be repaired by whichever of the following methods are appropriate:

- (i) Repair by manual polishing
- (ii) Installation of repair sleeves over the damaged part
- (iii) Installation of compression joints
- (iv) Replacement with new conductor

Slight damage such as superficial scratches or abrasions, which are not deeper than one-third of the strand diameter, can be repaired by dressing with a fine emery cloth.

Severe cuts which cannot be repaired with emery cloth due to their depth or extension, and cause an increase in the resistance of the external layers shall be repaired by use of repair sleeves, provided that not more than one-third of the outer layer is cut or damaged over a length of less than 10 centimeters.

Damages of an extent greater than described in the above paragraphs shall be repaired by replacing the damaged length of the cable using compression joints.

When there is repeated damage in the same span or consecutive spans, the Engineer or his nominated person may require all conductors in these spans to be replaced.

In the case when signs of corrosion are detected during the stringing operation, the reels containing corroded conductors shall be set aside, the

operation shall be interrupted and the Engineer or his nominated person shall be informed immediately.

Whenever a repair sleeve is installed, a rope cage shall be placed on the sleeve to ensure that there will be no damage from sub-conductor slapping before the installation of the spacer dampers.

(c) **Jumper Connections**

Where compression-type dead-ends are used, the jumper shall be one continuous piece, and compression-type jumper terminals bolted to the compression-type dead-ends shall be used.

At overhead ground wire compression type dead-ends clamps and OPGW with thimble clevis and grip dead end, sufficient length of wire to form the jumper loop to clear the tower shall be allowed. Parallel groove bolted clamps will be used for the connection.

(12) **OPGW Jointing/Splicing and Installation of OPGW Joint Boxes**

OPGW jointing/splicing and joint box installation will be carried out by the Contractor. However, following general instructions should be followed:

No mid-span joint shall be allowed in the OPGW. All joints shall be performed in a joint box located on the tower just above the location of the anti-climbing device. OPGW jointing (splicing) and joint box installation including supporting devices for joint boxes shall be executed by the Contractor. OPGW shall be dropped to the joint boxes along with tower braces by installing OPGW-attaching clamps at about one-meter intervals.

1.8 Installation of Dampers

(1) **Spacer Dampers**

The four sub-conductors of each phase shall be secured to each other using spacer dampers installed strictly following the data furnished.

The intervals, measured along the length of the conductors at which spacers are installed shall be as shown on the data sheets with tolerances not more than plus/minus 1.0 meter.

Spacer-dampers shall be installed in a span only after that span has been dead-ended and clipped in. The installation of spacer dampers shall be completed in each section within 72 hours after the sub-conductors have been sagged.

The clamps shall be properly aligned on the conductors. The distorted shape of the spacer dampers will be considered an unsatisfactory installation and shall be corrected or the spacer damper replaced.

The bolts of the breakaway type shall be tightened until the outer head breaks off.

Spacer dampers shall be installed with the bolt heads in a downward position for viewing from the ground.

(2) Spacer

The four sub-conductors of each jumper phase shall be secured to each other using a spacer installed strictly following the data furnished.

Two (02) nos. of Spacers will be installed between the yoke plate of the jumper assembly and the dead-end joint of tension assembly of either side and a total of four (04) in one complete jumper length.

The bolts of the breakaway type shall be tightened until the outer head breaks off.

(3) Vibration Dampers

Vibration dampers shall be attached to the OPGW at the ends of all spans and as designated on the data sheets. The vibration dampers shall be fastened securely to OPGW so that they will hang in vertical planes. The spacing of dampers shall be following the Drawings. Breakaway-type bolts shall be tightened until the outer head breaks off.

2 PRE-COMMISSIONING AND COMMISSIONING TESTS

2.1 Pre-Commissioning Tests

a) Mechanical Tests

1. For steel structures, ensure that the structure type is as per the specifications/drawings/structure list.
2. Check galvanizing and thickness (rust is not acceptable).
3. Check bolt types and tightness (torque wrench method).
4. Ensure anti-climbing guards are correctly installed.
5. Check step bolt tightness.
6. For insulators, check insulators for chips, cracks, etc. Ensure the correct number of insulators have been installed in each string. Ensure that cotter keys have been properly installed.
7. Make sure that insulators are clean and the line is safe to be energized.
8. Check that all line hardware and fittings (insulators, corona rings, vibration dampers, spacer dampers, conductor clamps, armour rods, etc.) are installed correctly and in the correct locations as per specifications and drawings.
9. Check that all splices are correct and installed in the correct span locations.
10. Check that all jumpers are installed correctly. Ensure correct clearances between jumper and structure as well as with other phases at acute angle locations.
11. Ensure there is no twist in the insulator string.

12. Check that the OPGW are grounded at each tower location as specified.
13. Ensure that sags for phase and overhead ground conductors are even and according to the specifications.
14. Check that ground clearances are as per specification.
15. Check circuit/phase identification plates, structure number plates, danger sign plates, etc. have been correctly installed at each structure and aerial markers at the required structures.
16. Check line/phase is correctly transposed at the specified locations and that clearance between the phases is as per specification.

b) Electrical Tests

1. Check tower footing resistance as per specification.
2. Verification of physical phase arrangement.
3. Perform sequence impedance test (both zero and positive sequence).
4. Perform continuity and insulation tests of complete transmission lines with appropriate test equipment.
5. Tests on OPGW:
 - OTDR test of each fiber
 - Attenuation test
 - Continuity test

11.2 Commissioning Tests

1. Perform phase sequence/rotation check.
2. Inspection of Facilities for any visual/audible abnormality.

NATIONAL TRANSMISSION AND DESPATCH COMPANY LIMITED (NTDC)



REVISED SOP FOR BLACKLISTING

(As on 25.02.2019)

Table of Contents

CHAPTER NO.1.....	3
1.1 INTRODUCTION	3
1.2 EXTENT OF APPLICATION.....	3
CHAPTER NO. 2.....	5
2. REASONS OF BLACKLISTING	5
CHAPTER NO. 3.....	7
3. FORMULATION OF “NTDC’S RIGHTS PROTECTION COMMITTEE”	7
CHAPTER NO. 4.....	8
4.1 PROCEDURE FOR BLACKLISTING	8
4.2 INITIATION OF AN ACTION.....	8
4.3 DECISION.....	8
4.4 COMMUNICATION OF DECISION.....	9
4.5 PERIOD OF DEBARMENT FOR BLACKLISTED FIRMS	9
Note: All the penalties given herein above will be in addition to the consequences already agreed by the parties in the contract or any other document and other remedies provided under the law.	
4.6 ACTION AFTER FIRMS ARE PLACED ON BLACKLISTING	9
4.7 EFFECTIVENESS.....	10
APPENDIX-1	11
APPENDIX-2	13
REFERENCES	

CHAPTER NO.1

1.1 INTRODUCTION

The main objectives of any procurement process are transparency, economy, fairness and efficiency so that value for money is achieved.

Blacklisting is one of the most effective tools used in the struggle against inefficiencies and corruption in connection with public procurement. In addition, it serves as a major deterrent against any material breach of contract and further ensures the timely execution of projects by holding delinquent persons accountable.

Rule-19 “Blacklisting of suppliers and contractors” of the Public Procurement Rules, 2004 (hereinafter “**PPRA Rules**”) stipulates that;

“The procuring agencies shall specify a mechanism and manner to permanently or temporarily bar, from participating in their respective procurement proceedings, suppliers and contractors who either consistently fail to provide satisfactory performances or are found to be indulging in corrupt or fraudulent practices. Such barring action shall be duly publicized and communicated to the Authority: Provided that any supplier or contractor who is to be blacklisted shall be accorded adequate opportunity of being heard.”

In the light of the Clause above, this SOP has been drafted for procurements made by NTDC.

Any capitalised terms and abbreviations used in this SOP which are not defined herein shall have the meanings given to them in Public Procurement Regulatory Authority Ordinance, 2002 (hereinafter “**PPRA Ordinance**”) and PPRA Rules.

1.2 EXTENT OF APPLICATION

- i. The procedure shall be applicable and remain in force, along with any amendments thereto, within NTDC until any clear instructions or guidelines are imparted by the Government through PPRA, PEC, or any other competent forum.
- ii. The procedure shall also be applicable on the pre-qualified firms.
- iii. The procedure shall be applicable on any “Person”, which for the purposes of this SOP shall *interalia* include suppliers, bidders, contractors, consultants, firms, individuals, and organizations transacting business with NTDC.
- iv. Wherever any provision of this SOP shall be in conflict with provisions of any applicable guidelines of donor agencies, or any other applicable Statute / Law or Rule enforced at the time in Pakistan, the provisions of such applicable guidelines, laws, or rules shall prevail.

- v. This SOP shall become a part of the future Bidding Documents and the person(s) will submit an Undertaking along-with his bid that he has read and accepts the provisions of this SOP. Non-submission of an Undertaking may result in rejection of his bid. The said Undertaking will subsequently become part of the Contract Agreement as well.



CHAPTER NO. 2

2. REASONS OF BLACKLISTING

2.1 The causes and reasons to be taken into consideration for Debarment / Blacklisting of any person are given as under:

2.1.1 Pre- Award Stage:

The following shall be considered, *interalia*, the causes / reasons for initiating proceedings under this SOP at the Pre-Award Stage:

- i. Indulging in Corrupt, Fraudulent as well as Collusive practices.
- ii. Submission of false and spurious documents, making false statements, making frivolous complaints and allegations to gain undue advantage.
- iii. Commission of embezzlement, criminal breach of trust, theft, cheating, forgery, bribery, falsification or destruction of records, receiving stolen property, false use of trademark, securing fraudulent registration, giving false evidence, furnishing of false information of serious nature.
- iv. Submission of false bid security or infringement of documents to get undue monetary or any other benefit.
- v. Breach of confidentiality of evaluation process as mentioned in Appendix-1 based on illegal access or in any way to get undue benefit or to provide benefit or to frustrate the bidding/evaluation process. This will also include attempts to sabotage the bidding process directly or indirectly.

2.1.2 Post- Award Stage:

The following shall be considered, *interalia*, the causes / reasons for initiating proceedings under this SOP at the Post-Award Stage:-

- i. Extraordinary delay in signing or refusal to accept the Notification of Award and/or the contract without any cogent reason.
- ii. Misconduct, i.e., failure to proceed with the signed contract, withdrawal of commitments, quoting an unreasonably and unfairly low financial offer and subsequently withdrawing such an offer, frustrating the evaluation/bidding process and not responding to written communication in a reasonable time.
- iii. Causes mentioned in Clause 2.1.1 (i, ii & iii) above.
- iv. Submission of fake / frivolous or mutilated Performance Guarantee or Advance Payment Guarantee etc.

- v. Non-satisfactory performance as mentioned in Appendix-2 during the execution of the contract.
- vi. Non-performance or Breach of provisions / clauses of the contract agreements.
- vii. Notwithstanding the warranty/defect liability period, any defect in a product, equipment, plant, facility or services rendered that may subsequently surface during field operations within 5 years of its commissioning.
- viii. Failure to honour obligations within warranty period or defect liability period as defined in the contract.

2.1.3 Other Causes

- i. The person is blacklisted by any Government department in Pakistan, or it is established that the firm is involved in any kind of corruption or corrupt practices anywhere in the world.
- ii. Violations of provisions / instructions set down in the Bidding Documents.
- iii. Any attempt / activity to malign or bring NTDC into disrepute and harm its interest(s).
- iv. Person(s) blacklisted by International Financial Institutions (donor agencies) will be liable to be blacklisted after receipt of confirmation from the donor agencies without any further proceeding.
- v. Any other cause deemed just and appropriate by NTDC in the given circumstances.

Note:

- (1) If above mentioned causes occur either on part of the principal bidder or the local agent, both shall be considered for blacklisting / debarment.
- (2) The authorization of the foreign bidder to local agent shall contain his complete particulars including the name of the company, name of the owner, National Tax number (NTN), CNIC (Computerized National Identity Card) No. etc. In case, the said information is found to be missing, even after calling for the same within a reasonable time, the authority letter shall not be accepted.
- (3) The Bidding Documents shall be issued against original authority letter or in case of scanned copy, the email of the foreign bidder shall be enclosed. However, at the time of bidding, the original authority letter shall be attached with the bid. In the absence of the same, the bid shall be rejected.

CHAPTER NO. 3

3. FORMULATION OF “NTDC’S RIGHTS PROTECTION COMMITTEE”

3.1 A permanent Committee namely “NTDC’s Rights Protection Committee (**RPC or Committee**)” comprising of the following members shall examine the justification of the reasons given by the Project Authority prior to blacklisting / debarment of any firm/supplier/contractor/ individual.

- General Manager (Performance Assessment) NTDC Convener
- Chief Engineer (Reliability Compliance) NTDC Member
- Representative of the Chief Law Officer’s Office Member

Depending upon the nature of the case, the Committee may consult or appoint / nominate additional members from within NTDC with the approval of Managing Director (NTDC), provided that the Committee consists of an odd number of individuals as per spirit of Rule 48(1) of the PPRA Rules. Independence of any additional members shall be ensured while making the selection of such additional members. Furthermore, the aforementioned RPC shall also be authorized to seek external expert advice as and when required.

CHAPTER NO. 4

4.1 PROCEDURE FOR BLACKLISTING

Upon receipt of or obtaining information and/or knowledge that any person(s) is involved in practices mentioned in Chapter-2 earlier, the concerned Project Authority / formation shall promptly formulate its recommendations and submit through MD NTDC to NTDC RPC along with its findings, details of charges and documentary evidences to initiate proceedings under this SOP.

4.2 INITIATION OF AN ACTION

- (i) Within a period of 15 days after receiving the recommendations of Blacklisting / Debarment from the concerned Project Authority, the Convener of the Committee shall issue a Show Cause Notice (“Notice”) thereby informing the Person about the alleged charges and shall provide an opportunity to the defend said charges within a time period of 15 (fifteen) days.
- (ii) The person(s) shall be accorded adequate opportunity of hearing in order to defend the charges within the given timelines.
- (iii) The Notice to the Person shall be sent at the mailing/postal address as provided under the Contract or any other address provided by way of subsequent written communication by the Person. The non-receipt of the Notice due to incorrect / change in mailing address without any written communication shall not be attributable to NTDC. In case of non-receipt of any reply from the accused person within the formulated time, but not less than the time given in 4.2 (i) above, the Committee shall have the right to proceed on Ex-parte basis.

4.3 DECISION

- i. The committee shall hold an independent inquiry/investigation as the case may be, and, which may include site visits and interviews with the parties concerned. The Committee shall complete the entire inquiry/investigation, preferably within a period of 30 days after receipt of response from the person against whom proceedings under this SOP have been initiated and shall present the report to the MD NTDC.

- ii. If required, the Committee may report the case to an appropriate law enforcement agency depending upon the nature of the case for detailed investigations with the prior approval of Managing Director (NTDC).
- iii. The person against whom proceedings have been initiated under this SOP shall not proceed for arbitration/litigation during the proceedings for blacklisting.

4.4 COMMUNICATION OF DECISION

After recommendation for blacklisting by “NTDC’s Rights Protection Committee (RPC)”, the person concerned shall be informed within 10 days of such decision. The decision of the Committee will be notified on NTDC’s and PPRA’s websites and shall also be conveyed to Pakistan Engineering Council. Blacklisting of firms shall also be conveyed by circular to other Government Departments. All other relevant procuring agencies including PEPCO, DISCOs, and WAPDA, etc., will also be informed simultaneously.

4.5 PERIOD OF DEBARMENT FOR BLACKLISTED FIRMS

- (i) The Blacklisting on the grounds and reasons specified herein above in Chapter No. 2 shall be for a reasonable specified period of time and as a general rule of prudence, the period may not exceed three years, except in cases where debarment/blacklisting has been done by any other government department or an International Financial Institution (Donor Agency).
- (ii) In case the person has been blacklisted by the government department or the International Financial Institution (donor agency), the period of blacklisting/debarment shall be for a maximum period of 3 years or the time period for which the concerned government department/International Financial Institution (Donor Agency) debarred the contractor (whichever is higher).

4.6 ACTION AFTER PERSONS ARE PLACED ON BLACKLISTING LIST.

- i. The decision of blacklisting will be immediately circulated to all concerned as mentioned at Clause 4.4 above.
- ii. In case of a contract already awarded to a person which has been blacklisted and termination is either not possible or not feasible, the concerned Project Authority may proceed in this case to complete the contract with the approval of Competent Authority.
- iii. The blacklisted person shall stand disqualified from bidding from the date of decision against them. Any pending bids shall also stand rejected. If a contract has

already been awarded to person, it shall be voidable at the option of NTDC as per 4.6 (ii) above.

- iv. A separate register or data base will be maintained for blacklisted firms indicating reasons and period.

4.7 EFFECTIVENESS

These guidelines / SOP or any amendments thereof shall take effect immediately after its approval from Board of Directors of NTDC.



APPENDIX-1

PROCESS TO DEAL WITH FRIVOLOUS COMPLAINTS

It has been frequently observed that after opening of tenders, the bidders start to influence the evaluation process. Such attempts result in delay in finalizing of award of contract and cause financial loss to the National exchequer. The evaluation process is confidential till publication of award of contract process.

Provision of guidelines of international donor agencies and PPRA provides sufficient opportunity to bidders for redressal of their grievances. Hence, the attempts made by the bidders during evaluation process or thereafter to influence the contract award decisions fall under the definition of corrupt and fraudulent practices. Therefore, during bidding stage, the following mechanism shall be adopted in case of receipt of any frivolous complaint from the bidder.

- i. Anonymous complaints shall not be entertained.
- ii. The Procuring Agency reserves the right to call for an affidavit from the complainant verifying the truthfulness and correctness of the contents of the complaint.
- iii. The notice of displeasure and explanation will be immediately sent to those persons who lodge frivolous complaint(s) during the evaluation process.
 - iii (a) If the person itself or through its agent or any third party does not refrain from making frivolous complaints in the same tender or any other tender, an official warning will be sent and their case may be sent to “NTDC’s Rights Protection Committee” which may analyse the situation and suggest action including the rejection of the bid of the complainant. However, Project Authority may reject the bid even in first instance depending upon nature of the case or provision of the Bidding Documents.
 - iii (b) If the same person itself or through its agent or any third party lodges a frivolous complaint in another tender floating in parallel before decision of the Grievance Committee, its bid will straight forwardly be rejected by the project authority. It may also be debarred to participate in the next tender for a minimum period of six months under intimation to the Grievance Committee and MD NTDC.
- iv. In order to monitor the record of the persons, a data base will be maintained at NTDC’s website and the offices of the project authorities regarding such persons who consistently lodge frivolous complaints during the evaluation process by making clandestine access to confidential record and hamper the award of contract process.

NOTE: It is clarified that the process provided above in Appendix 1 is to discourage anonymous and frivolous complaints only, and does not bar any person feeling aggrieved by any act of the procuring agency from lodging a genuine complaint/grievance as provided under Rule 48 of the PPRA Rules, 2004.



APPENDIX-2

GUIDELINES FOR EVALUATION OF PERFORMANCE OF CONTRACTORS

- i. After signing of the contract, the Project authority (or the Consultant / Engineer) must monitor and evaluate the Contractor's performance, that is, whether the Contractor is fulfilling his obligations based on the terms of the contract and plans that were developed and agreed upon with the Project authority at the time of signing of contract or during kick-off meetings..
- ii. Though the performance evaluation of any person is an on-going process, which takes place throughout the duration of the contract and also during the Defect Liability / Warranty Period, nevertheless, a person's Performance Evaluation Report may be prepared for the consumption and benefit of the procuring agency or for any other purpose at the completion of the project, as the case may be.
- iii. The performance evaluation report shall be prepared for all contracts of more than Rs. 100 million. When based on the Evaluation Report, the performance of a person is non-satisfactory, the procuring agency may initiate the case for blacklisting of the person in accordance with the terms of this SOP. For the avoidance of doubt, consistent failure to provide satisfactory performance shall also include performances in a single or multiple contracts executed or being executed by the same person, as the case may be.
- iv. In case of any extra-ordinary delay in performance of a single contract of vital and critical importance, the procuring agency shall have the right to initiate proceedings under this SOP and/or avail any other remedy provided under the law which may *interalia* include: termination of the contract, recovery of losses, debarring the person from participation in future tenders. The procuring agency shall be the sole judge to determine the projects of vital or critical importance.
- v. In case of ordinary delay in performance in 2 consecutive contracts within a period of 3 years, the procuring agency shall have the right to initiate proceedings under this SOP and/or avail any other remedy provided under the law which may *interalia* include: termination of the contract, recovery of losses, debarring the person from participation in future tenders.
- vi. The proceedings under this SOP shall not prejudice any other rights and/or remedies available to the procuring agency under the contract documents and/or any other law in force.



National Grid Company of Pakistan Limited (NGC)

(Formerly NTDC)

OFFICE OF CHIEF ENGINEER (CIVIL)

Ref No. CE(CIVIL)/NGC/MDC/2371/2178-82

Date: 23-02-2026

Project Director (EHV-),
NGC, Lahore.

Subject: CONVERSION OF TOWER NOS. 42 & 43 OF 220KV D/C TWIN BUNDLE T/LINE FROM SHEIKHUPURA RAVI (1&2) FROM SUSPENSION TYPE TO TENSION TYPE

Ref: RELEASE OF FOUNDATION DESIGN

- Your office Letter No. PD/EHV/Lahore/958-62 Dated 11-02-2026
- Chief Engineer (T/L Design) office Letter No. CE/TLD/NTDC/MTL-I/L-133/427-30 Dated 11-02-2026

With reference to your letter at [i], wherein this office was requested to issue foundation design for conversion of Tower Nos. 42 & 43 of 220kV Sheikhpura-Ravi T/line from suspension type to tension type. So, keeping in view the urgency of work, prevailing site conditions and information/data provided by your representative; the type of foundations have been worked out as per approved profile & plan tabling Drawing No. PDW/TL-9520 & 9521 vide letter at ref [ii] of subject transmission line. The following design/drawings of foundations are being issued with modifications marked in "red" for implementation at site after fulfilling all codal formalities at your end:

Tower Location No.	*Tower Type	Foundation Drawing	Pile Length 'D' below Pile Cap (m)	Remarks
42 New	EG	PDW/TC-956/ Single pile per leg	20	Stub setting dimension be kept as per approved profile, foundation & stub setting drawings
43 New	EG	PDW/TC-956/ Single pile per leg	20	

The relevant instructions/ provisions mentioned in the above drawings should be strictly followed. Moreover, if during execution of foundations at site, peculiar subsoil/ground conditions are observed i.e. not according to design parameters provided to this office, the matter may be referred back to this office.

The above approval does not relieve the Contractor of his responsibility for full compliance with all terms and obligations under the Contract.

Moreover, minimum three coats of bitumen coating (ExpanProof* 10 – Fospak bitumen) shall be applied to exposed concrete surfaces before backfilling of foundations.

*Tower make ups should be as per approved profile & plan tabling Drawing No. PDW/TL-9520 & 9521 of subject Transmission line vide letter at ref [ii].

DA/As Above

Copy to:

- General Manager (PD/GSC) North NGC WAPDA House, Lahore.
 - Chief Engineer (PD/GSC) North NGC, NTDC House, Lahore.
 - Chief Engineer (T/L Design) NGC, WAPDA House, Lahore.
 - Executive Engineer (EHV-I) T/L 'C' Division NGC, Lahore.
- Master File -Relevant File

Manager Design (Civil) NGC

Address: Office No. 108-Wapda House, Lahore Pakistan Tel No: 042-99203527-28 Email : cecivil@ntdc.com.pk

Striving for Reliable Grid

FOR EG
 TRUE BATTER = 28.28 : 100
 PROJECTED BATTER = 20.00 : 100

FOR JKD
 TRUE BATTER = 31.40 : 100
 PROJECTED BATTER = 22.20 : 100

SETTING OUT DIMENSIONS FOR TOWER TYPE EG

TOWER NAME	11P	F	R
B+O+2.0	8320	8320	8320
B+O+4.0	8760	8548	
B+O+6.0	7180	10111	
B+O+8.0	7620	10877	

SETTING OUT DIMENSIONS FOR TOWER TYPE JKD

TOWER NAME	11P	F	R
B+O+1.5	4624	8200	
B+O+3.0	4884	7021	
B+O+4.5	5287	7481	
B+O+6.0	5830	7982	

NOTES

- ALL DIMENSIONS ARE GIVEN IN MILLIMETERS
- ALL R.C.C. TO HAVE CYLINDER CRUSHING STRENGTH OF 24N/mm² (3600PSI) AT 28 DAYS FOR PILE CAP & 28N/mm² (4000PSI) FOR PILES.
- REINFORCEMENT TO BE BILLET STEEL INTERMEDIATE GRADE DEFORMED BARS WITH YIELD STRENGTH OF 281 N/mm² CONFORMING TO ASTM A-615.
- CONCRETE SHOULD BE VIBRATED WITH A VIBRATOR OF 7500 RPM MAXIMUM.
- AGGREGATE SHOULD BE WELL GRADED AND MAXIMUM SIZE OF COARSE AGGREGATE SHALL NOT BE MORE THAN 20mm FOR PILE AND 38mm FOR PILE CAP CONFORMING TO ASTM C-33.
- CONCRETE SHOULD BE MIXED BY MECHANICAL MEANS.
- SULPHATE RESISTANCE CEMENT TO BE USED AS PER CHEMICAL ANALYSIS OF SOIL AND WATER.
- AGGREGATE SHOULD BE FREE FROM ORGANIC MATTER, MUST BE USED.
- CONCRETE BE CURED FOR 28 DAYS.
- COARSE SAND SHOULD BE FREE FROM SALT AND DUST.
- CONCRETE SLUMP SHOULD NOT EXCEED 75mm FOR PILE CAP AND 150mm FOR PILE.
- MINIMUM CLEAR COVER OF 75mm SHOULD BE PROVIDED WHERE NOT SHOWN.
- REINFORCEMENT BARS SHALL BE BENT RADIALLY INWARD WHEN PROVIDE LAP IN PILES.
- SPICES SHOULD BE AVOIDED AS FAR AS POSSIBLE.
- IF UNAVOIDABLE, OVERLAP SHOULD BE OF MINIMUM 40 TIMES BAR DIAMETER AND LOCATION OF SPICES SHOULD BE STAGGERED.
- DRILLING OF BORE HOLES AND DRIVING OF PILES SHOULD BE CARRIED OUT BY STANDARD METHODS.
- CONTROL OF AXIAL ALIGNMENT SHOULD BE STRICTLY OBSERVED / VERIFIED.
- CONSTRUCTION METHOD SHOULD ENSURE THAT THE PILE HOLE SHOULD BE PROPERLY LOCATED IN PLUMB. THE SOIL ADJACENT TO THE HOLE SHOULD NOT BE UNDESIRABLY DISTURBED. A CLEAR HOLE OF SPECIFIED DIMENSIONS SHOULD BE PROVIDED FOR THE ENTIRE LENGTH. CONCRETE OF SPECIFIED STRENGTH AND DIMENSIONS SHOULD BE POURED CONTINUOUSLY IN A MANNER TO AVOID SEGREGATION.
- THE INSTALLATION OF PILES SHOULD BE PERFORMED IN SUCH A MANNER SO AS TO ENSURE THE STRUCTURAL INTEGRITY AND TO ACCOMPLISH THE DESIRED MAXIMUM POSSIBLE INTERACTION WITH THE SOIL SO THAT THE PILES MAY ADEQUATELY FULFIL ITS PURPOSE.
- EACH HOLE SHOULD BE INSPECTED BEFORE POURING OF CONCRETE TO ENSURE THAT IT HAS NOT BEEN CLOSED IN OR PARTIALLY FILLED BY SOIL MOVEMENTS OR PRESSURE.
- PORTABLE WATER SHOULD BE USED FOR ALL CONCRETING AND CURING.
- PORTLAND CEMENT CONFORMING TO ASTM DESIGNATION C-150 TYPE I SHOULD BE USED UNLESS OTHERWISE SPECIFIED.
- FOR FIRST 28 DAYS THE CONCRETE ABOVE N.S.L SHOULD BE KEPT UNDER CONTINUOUS WET BURLAPS OR APPLY CURING MEMBRANE.
- ALL MATERIAL AND WORKMANSHIP SHOULD BE ACCORDING TO STANDARD SPECIFICATIONS AS LAID DOWN IN WAPDA C.S.R LATEST EDITION.

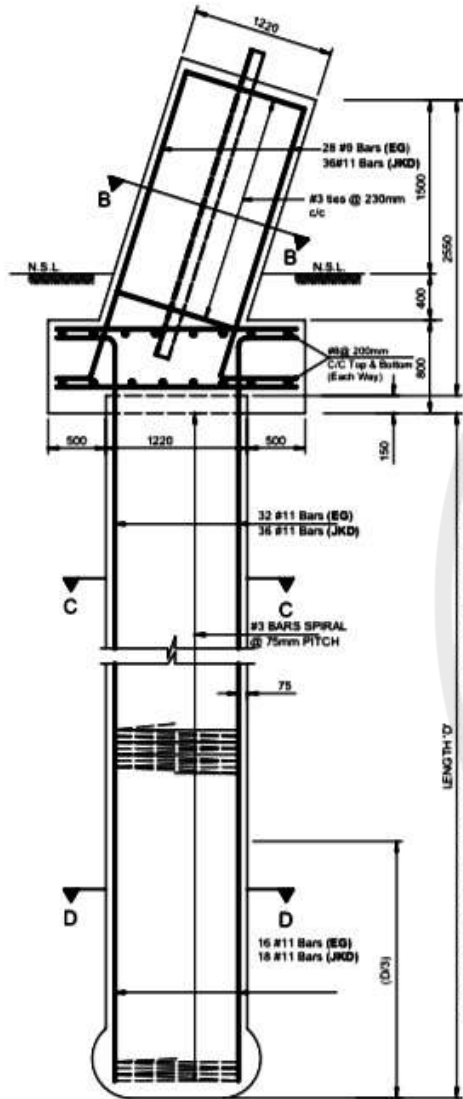

SECTION A-A

LENGTH OF PILE SHALL BE FINALIZED AFTER SOIL INVESTIGATION AT THE TOWER LOCATION

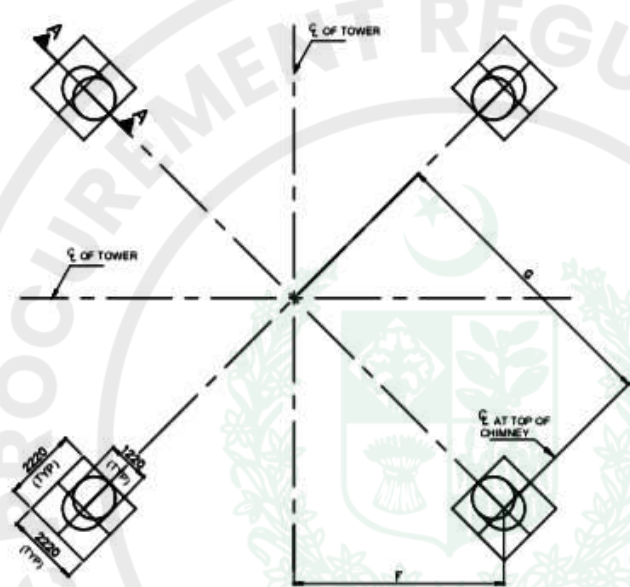

SETTING OUT FOUNDATION PLAN

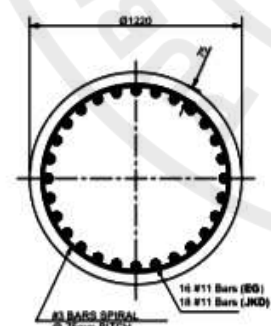

SECTION D-D

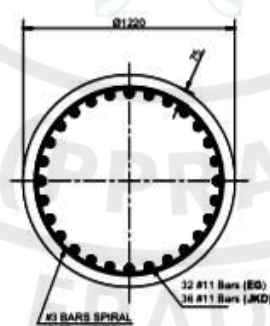

SECTION C-C

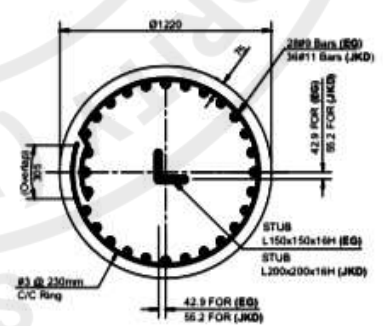

SECTION B-B

NATIONAL TRANSMISSION & DESPATCH COMPANY			C.E. DESIGN (INTC)
DRAWN	-	PILE FOUNDATION FOR 220 KV TRANSMISSION LINE TOWERS	
ASSTT. MANAGER	AKIF MAHBOOB		
ASSTT. MANAGER	-		
DY. MANAGER	ATTA MUHAMMAD		
MANAGER	MUHAMMAD AZIZ		
CHIEF	Muhammad Raoum	SCALE: - -	DATE: 01-11-2017
			DWG. NO. PDW/TC-956

FOR EG
 TRUE BATTER = 21.25 100
 PROJECTED BATTER = 20.00 100
 FOR JKD
 TRUE BATTER = 31.45 100
 PROJECTED BATTER = 22.20 100

SETTING OUT DIMENSIONS FOR TOWER TYPE EG

TOWER MAKE UP	F (mm)	G (mm)
T=D+2 D	6300	8180
B=D+4 D	8750	9745
D=D+6 D	2150	10111
H=D+8 D	2550	10677

SETTING OUT DIMENSIONS FOR TOWER TYPE JKD

TOWER MAKE UP	F (mm)	G (mm)
B=D+1.5 D	4532	5150
B=D+3 D	4904	5221
B=D+4.5 D	5297	5401
B=D+6 D	5630	5912

NOTES

1. ALL DIMENSIONS ARE GIVEN IN MILLIMETERS.
2. ALL R.C.C. TO HAVE CYLINDER CORUSING STRENGTH OF 27MPa OR BETTER AT 28 DAYS FOR PILE CAP & BRIDGE HEADS FOR PILES.
3. REINFORCEMENT TO BE BUILT WITH WHITE GRACE PORTLAND CEMENT WITH TENSILE STRENGTH OF 381 N/mm² CONFORMING TO ASTM A411.
4. CONCRETE SHOULD BE VIBRATED WITH VIBRATOR OF 1000 WPM MAXIMUM.
5. AGGREGATE SHOULD BE WELL GRADED AND MAXIMUM SIZE OF COARSE AGGREGATE SHALL NOT BE MORE THAN 25mm FOR PILE AND 19mm FOR PILE CAP CONFORMING TO ASTM C33.
6. CONCRETE SHOULD BE CURED BY MECHANICAL MEANS.
7. SULPHATE RESISTANCE CEMENT TO BE USED AS PER CHEMICAL ANALYSIS OF SOIL AND WATER.
8. AGGREGATE SHOULD BE FREE FROM ORGANIC MATTER. MUST BE WASHED.
9. CONCRETE BE CURED FOR 28 DAYS.
10. COARSE SAND SHOULD BE FREE FROM SALT AND CLAY.
11. CONCRETE SLAP SHOULD NOT EXCEED 75mm FOR PILE CAP AND 150mm FOR PILE.
12. MINIMUM CLEAR COVER OF 15mm SHOULD BE PROVIDED WHERE NOT SPECIFIED.
13. REINFORCEMENT BARS SHALL BE BENT RADIALLY INWARD WHEN PROVIDE LAP IN PILES.
14. SPLICES SHOULD BE AVOIDED AS FAR AS POSSIBLE.
15. IF UNAVOIDABLE, OVERLAP SHOULD BE OF MINIMUM 40 TIMES BAR DIAMETER AND LOCATION OF SPLICES SHOULD BE STAGGERED.
16. DRILLING OF BORE HOLES AND DRIVING OF PILES SHOULD BE CARRIED OUT BY STANDARD METHODS.
17. CENTRAL OF AXIAL ALIGNMENT SHOULD BE STRICTLY OBSERVED/VERTICAL.
18. CONSTRUCTION METHOD SHOULD ENSURE THAT THE PILE HOLE SHOULD BE PROPERLY LOCATED IN PLAINS THE SOIL ADJACENT TO THE HOLE SHOULD NOT BE UNLATERLY DISTURBED A CLEAR HOLE OF SPECIFIED DIMENSIONS SHOULD BE PROVIDED FOR THE ENTIRE LENGTH. CONCRETE OF SPECIFIED STRENGTH AND DIMENSIONS SHOULD BE POURED CONTINUOUSLY IN A MANNER TO AVOID SEGREGATION.
19. THE INSTALLATION OF PILES SHOULD BE PERFORMED IN SUCH A MANNER SO AS TO ENSURE THE STRUCTURAL INTEGRITY AND TO ACCOMPLISH THE DESIRED MAXIMUM POSSIBLE INTERACTION WITH THE SOIL SO THAT THE PILES MAY ADEQUATELY FULFILL THEIR PURPOSE.
20. EACH HOLE SHOULD BE INSPECTED BEFORE POURING OF CONCRETE TO ENSURE THAT IT HAS NOT BEEN CLOSED OR PARTIALLY FILLED BY SOIL MOVEMENTS OR PRESSURE.
21. PORTABLE WATER SHOULD BE USED FOR ALL CONCRETING AND CURING.
22. PORTLAND CEMENT CONFORMING TO ASTM SPECIFICATION C-150 TYPE I SHOULD BE USED UNLESS OTHERWISE SPECIFIED.
23. FOR FIRST 28 DAYS THE CONCRETE ABOVE GROUND SHOULD BE KEPT UNDER CONTINUOUS WET BURLAPS OR APPLY CURING MEMBRANE.
24. ALL MATERIAL AND WORKMANSHIP SHOULD BE ACCORDING TO STANDARD SPECIFICATIONS AS Laid DOWN IN IS/SP C 88 LATEST EDITION.

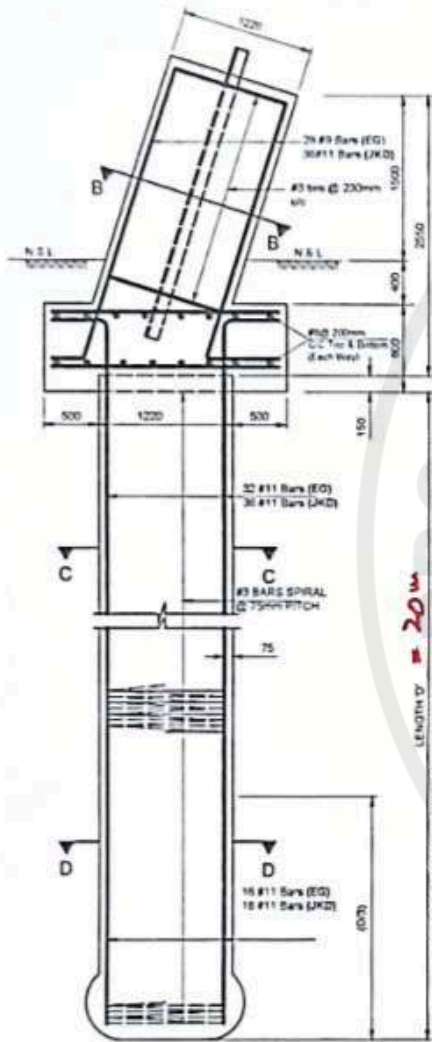

SECTION A-A

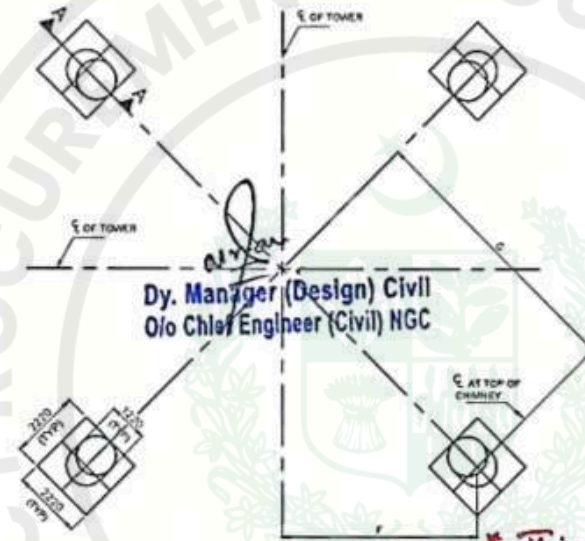

SETTING OUT FOUNDATION PLAN

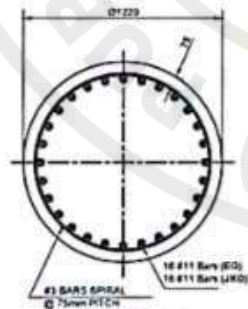

SECTION D-D

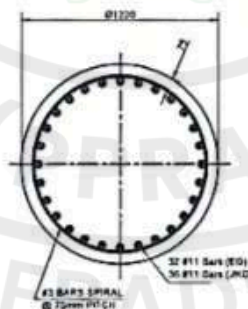

SECTION C-C

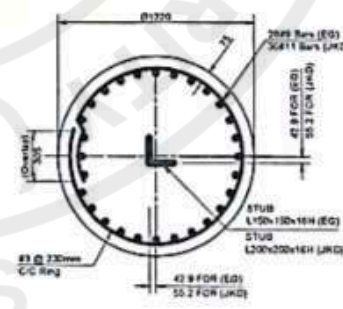

SECTION B-B

LENGTH OF PILE SHALL BE FINALIZED AFTER SOIL INVESTIGATION AT THE TOWER LOCATION

** This drawing is issued in conjunction with this file letter no. 2178-82 dated 23-02-2026*

** Start setting dimensions shall be as per tower type and make.*

NATIONAL TRANSMISSION & DESPATCH COMPANY			C.E. DESIGN (INT/EC)
DESIGNER		PILE FOUNDATION FOR 220 kV TRANSMISSION LINE TOWERS	
ASST. MANAGER	AKIF RAHIMOV		
ASST. MANAGER			
DR. MANAGER	ATTA MUHAMMAD		
MANAGER	MUHAMMAD ADZ	SCALE: -	DATE: 10-11-2017
CHIEF	Muhammad Samir	ENCL. NO. RSN/TC-458	

Past Experience / Contracts

Contracts over *[insert amount]* during the last three years:

Procuring Agency	Value	Year	Goods/Services Supplied	Country of Destination

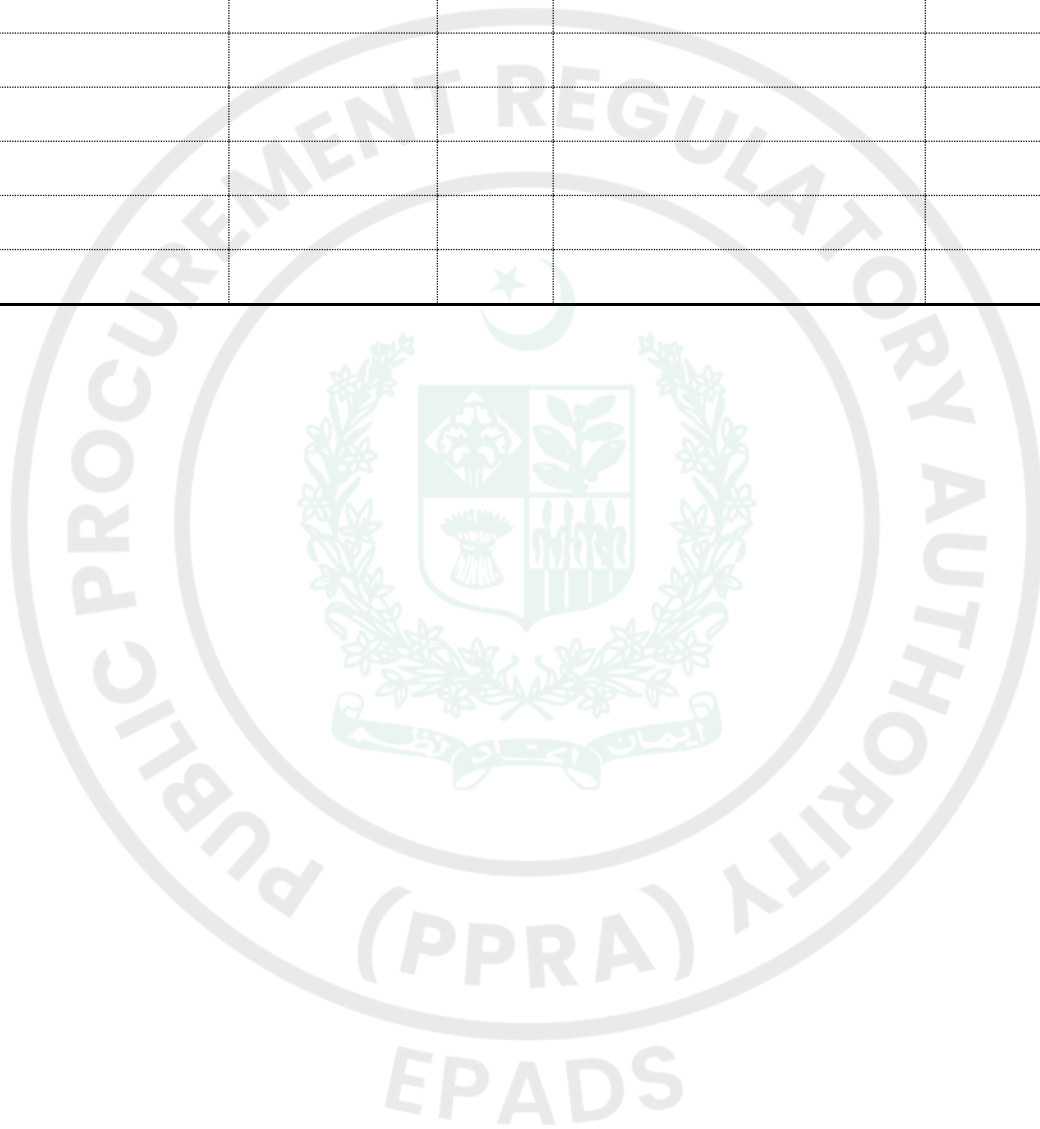

Historical Contract Non-Performance, and Pending Litigation and Litigation History

[The following table shall be filled in for the Applicant and for each member of a Joint Venture]

Applicant's Name: *[insert full name]*

Date: *[insert day, month, year]*

Joint Venture Member Name: *[insert full name]*

IFP No. and title: *[insert IFP number and title]*

Page *[insert page number]* of *[insert total number]* pages

<input type="checkbox"/> Not debarred due to deviation from commitment of Bid Securing Declaration- <input type="checkbox"/> Not debarred due to non-performance			
Year	Non-performed portion of contract	Contract Identification	Total Contract Amount (current value, currency, exchange rate and PKR equivalent)
<i>[insert year]</i>	<i>[insert amount and percentage]</i>	Contract Identification: <i>[indicate complete contract name/ number, and any other identification]</i> Name of Procuring Agency: <i>[insert full name]</i> Address of Procuring Agency: <i>[insert street/city/country]</i> Reason(s) for nonperformance: <i>[indicate main reason(s)]</i>	<i>[insert amount]</i>
Pending Litigation, in accordance with Section III, Qualification Criteria and Requirements			
<input type="checkbox"/> Pending litigation in accordance with Section III, Qualification Criteria and Requirements, Sub-Factor 2.3 as indicated below.			
Year of dispute	Amount in dispute (currency)	Contract Identification	Total Contract Amount (currency), US\$ PKR Equivalent (exchange rate)

<i>[insert year]</i>	<i>[insert amount]</i>	Contract Identification: [indicate complete contract name, number, and any other identification] Name of Procuring Agency: <i>[insert full name]</i> Address of Procuring Agency: <i>[insert street/city/country]</i> Matter in dispute: <i>[indicate main issues in dispute]</i> Party who initiated the dispute: <i>[indicate "Procuring Agency" or "Supplier"]</i> Status of dispute: <i>[Indicate if it is being treated by the Adjudicator, under Arbitration or being dealt with by the Judiciary]</i>	<i>[insert amount]</i>
<input type="checkbox"/> No consistent history of court/arbitral award decisions in accordance with Section III, Qualification Criteria and Requirements, Sub-Factor 2.4. <input type="checkbox"/> Consistent history of court/arbitral award decisions in accordance with Section III, Qualification Criteria and Requirements, Sub-Factor 2.4 as indicated below.			
Year of award	Outcome as percentage of Net Worth	Contract Identification	Total Contract Amount (currency), PKR Equivalent (exchange rate)
<i>[insert year]</i>	<i>[insert percentage]</i>	Contract Identification: [indicate complete contract name, number, and any other identification] Name of Procuring Agency: <i>[insert full name]</i> Address of Procuring Agency: <i>[insert street/city/country]</i> Matter in dispute: <i>[indicate main issues in dispute]</i> Party who initiated the dispute: <i>[indicate "Procuring Agency" or "Supplier"]</i> Court/ arbitral award decision: <i>[Indicate if the award decision was against the Applicant or any member of a joint venture.]y]</i>	<i>[insert amount]</i>

Current Contract Commitments / Contracts in Progress Form

1. Name of Contract(s)
2. Procuring Agency Contact Information [insert address, telephone, fax, e-mail address]
3. Value of outstanding contracts [current PKR equivalent]
4. Estimated Delivery Date
5. Average monthly invoices over the last six months (PKR/mon.)

Financial Situation and Performance

[The following table shall be filled in for the Applicant and for each member of a Joint Venture]

Applicant's Name: *[insert full name]*

Date: *[insert day, month, year]*

Joint Venture Member Name: *[insert full name]*

IFP No. and title: *[insert IFP number and title]*

Page *[insert page number]* of *[insert total number]* pages

1. Financial data

Type of Financial information in (currency)	Historic information for previous <i>[insert number]</i> years, <i>[insert in words]</i> (amount in currency, currency, exchange rate*, PKR equivalent)				
	Year 1	Year 2	Year 3		
Statement of Financial Position (Information from Balance Sheet)					
Total Assets (TA)					
Total Liabilities (TL)					
Total Equity/Net Worth (NW)					
Current Assets (CA)					
Current Liabilities (CL)					
Working Capital (WC)					
Information from Income Statement					
Total Revenue (TR)					
Profits Before Taxes (PBT)					
Cash Flow Information					
Cash Flow from Operating Activities					

* Refer ITA 14 for the exchange rate

3. Financial documents

The Applicant and in case of JV, members of JV shall provide copies of financial statements for *[number]* years pursuant Section III, Qualifications Criteria and Requirements. The financial statements shall:

- (a) reflect the financial situation of the Applicant or in case of JV member, and not an affiliated entity (such as parent company or group member).
 - (b) be independently audited or certified in accordance with local legislation.
 - (c) be complete, including all notes to the financial statements.
 - (d) correspond to accounting periods already completed and audited.
- Attached are copies of financial statements¹ for the *[number]* years required above; and complying with the requirements.

¹ If the most recent set of financial statements is for a period earlier than 12 months from the date of Application, the reason for this should be justified.

Average Annual Turnover (Annual Sales Value)

[The following table shall be filled in for the Applicant and for each member of a Joint Venture]

Applicant's Name: *[insert full name]*

Date: *[insert day, month, year]*

Joint Venture Member Name: *[insert full name]*

IFP No. and title: *[insert IFP number and title]*

Page *[insert page number]* of *[insert total number]* pages

Annual Turnover Data			
Year	Amount Currency	Exchange rate* (If applicable)	PKR equivalent
<i>[indicate calendar year]</i>	<i>[insert amount and indicate currency]</i>		
		Average Annual Turnover **	

* Refer ITA for date and source of exchange rate.

** Total PKR equivalent for all years divided by the total number of years. See Section III, Qualification Criteria and Requirements, ITA.