

# Standard Bidding Document

Procurement of Single Phase AMI Meter with GPRS (2G/4G)  
Communication Module  
(Goods)

National

Single Stage-Two Envelope



*July 03, 2026*

*Islamabad Electric Supply Company (IESCO) (Material Management Directorate), Chief Engineer (MM)  
IESCO Headquarters, Street # 40, Sector G-7/4., Islamabad Capital Territory  
Phone: +92-319-599-1800, Email: ce\_mm@iesco.com.pk*

# Table of Contents

---

<b>REQUEST FOR BIDS</b> .....	1
<b>Instructions to Bidders</b> .....	3
<b>Bid Data Sheet</b> .....	64
Bids Data Sheet (BDS) .....	24
Eligibility Criteria .....	29
Evaluation Criteria .....	30
Items/Lots .....	32
Related Services of Goods: .....	33
Items/Lot Specification .....	34
Price Schedule .....	35
<b>General Conditions of Contract</b> .....	37
<b>Special Conditions of Contract</b> .....	47
<b>Bid Securing Declaration</b> .....	53
<b>Contract Form</b> .....	55
<b>Integrity Pact</b> .....	58
<b>Performance Guarantee Form</b> .....	60
<b>Annexure</b> .....	63
Bid Data Sheet .....	64
Price Schedule Form .....	64
Production Capacity Form .....	64
IESCO AMI Specification .....	64

Declaration of Beneficial Owner .....	64
Bid Security Form .....	65
Power of Attorney .....	65
Bidder Information form .....	65
Bidder JV Member information form .....	65
Financial Resources Form .....	65
Financial Situation Form .....	65
Annual Average Turnover Form .....	66
Manufacturer Authorization Form .....	66
Deviations from Technical Provisions .....	66
Deviations from Contractual Condition .....	66
Eligible Countries .....	66
Schedule of Requirements .....	67
Special Conditions of Contract .....	47
<b>Procurement Forms</b> .....	<b>68</b>
Past Experience and Completed Contracts .....	1
Historical Contract Non-Performance, and Pending Litigation and Litigation History .....	1
Current Contracts and Their Progress .....	1
Financial Capacity and Net Worth Evaluation Form .....	1
<b>Additional Forms and Documents</b> .....	<b>71</b>

# REQUEST FOR BIDS

## PROCUREMENT OF GOODS

1. The **Islamabad Electric Supply Company (IESCO) (Material Management Directorate)** has reserved Funds for the procurement planned for FY **2026-27**. The **Islamabad Electric Supply Company (IESCO) (Material Management Directorate)** intends to apply part of the proceeds of this Fund to cover eligible payments under the contract for the "**Procurement of Single Phase AMI Meter with GPRS (2G/4G) Communication Module**" with the reference of "**P54704**"
2. The **Islamabad Electric Supply Company (IESCO) (Material Management Directorate)** invites sealed Bids from eligible Bidders for procurement of goods described in the bidding documents on **EPADS v2.0**.
3. **Single Stage-Two Envelope** will be used by adopting **Least Cost Based Selection (LCBS)** Technique for the subject procurement, in line with the Public Procurement Rules, 2004 and any Regulations, Regulatory Guides, Procurement Guidelines or Instructions issued by the Authority from time to time.
4. All Bids must be accompanied by a Bid Security amounting described in Bid Security Section in Bidding Document in the form of **Call at Deposit, Bank Guarantee** or all bids must be accompanied by bid securing declaration in the format specified in the Bidding documents
5. E-Bidding documents, containing detailed terms & conditions, specifications and requirements etc. are available on **e-Pak Acquisition and Disposal System (EPADS)** at **<https://epads.gov.pk/opportunities/federal/procurements/54704>** for all the interested bidders registered on **EPADS v2.0**. Bidders are required to get themselves registered on **EPADS v2.0** to participate in Bidding process.
6. The e-bids, prepared in accordance with the instructions in the e-Bidding Documents, must be submitted through **EPADS v2.0** on or before **Wednesday, July 22, 2026 10:30 AM**. E-bids will be opened using **EPADS v2.0** on the same day at **Wednesday, July 22, 2026 11:00 AM**. Manual

submission of Bids shall not be entertained. Those vendors who have not yet registered on the new version of **EPADS v2.0**, may register themselves on <https://vendors.epads.gov.pk/>. A tutorial to explain the registration process is available at <https://www.youtube.com/watch?v=MNW6T38v7tc>

In terms of Rule 48 of Public Procurement Rules, 2004 Grievance Redressal Committee (GRC) is notified for the subject procurement and notification copy is available on the procuring agency's website and on Authority's website at ([www.ppra.org.pk](http://www.ppra.org.pk)).

Islamabad Electric Supply Company (IESCO) (Material Management Directorate),  
Chief Engineer (MM)  
IESCO Headquarters, Street # 40, Sector G-7/4., Islamabad Capital Territory  
+92-319-599-1800  
ce\_mm@iesco.com.pk





## Instructions to Bidders

## A. Introduction

### 1.Scope of Bids

1.1 The Procuring Agency (PA), as indicated in the **Bids Data Sheet (BDS)** invites Bids **through EPADS v2.0** for the provision of Goods for as specified in the BDS and **in Section V - Evaluation Criteria, Specifications & Schedule of Requirements**. The name, identification, and number of items/deliverables are provided in the **BDS**. The successful Bidders will be expected to provide the goods within the specified period and timeline(s) as stated in the **BDS**.

### 2. Source of Funds

2.1 Source of funds is referred in Clause-1 of Invitation for Bids.

### 3. Eligible Bidders

3.1 A Bidder may be natural person, company or firm or public or semi-public agency of Pakistan or any foreign country, or any combination of them with a formal existing agreement (on Judicial Papers) in the form of a joint venture, consortium, or association. In the case of a joint venture, consortium, or association, all members shall be jointly and severally liable for the execution of the Contract in accordance with the terms and conditions of the Contract. The joint venture, consortium, or association shall nominate a Lead Member as nominated in the BDS, who shall have the authority to conduct all business for and on behalf of any and all the members of the joint venture, consortium, or association during the Bidding process, and in case of award of contract, during the execution of the contract.

3.2 Verifiable copy of the agreement that forms a joint venture, consortium or association shall be required to be submitted as part of the Bid.

3.3 The appointment of Lead Member in the joint venture, consortium, or association shall be confirmed by submission of a valid Power of Attorney to the Procuring Agency.

3.4 Any bid submitted by the joint venture, consortium or association shall indicate the part of proposed contract to be performed by each party and each party shall be evaluated (or post qualified if required) with respect to its contribution only, and the responsibilities of each party shall not be substantially altered without prior written approval of the Procuring Agency and in line with

any instructions issued by the Authority.

*(The limit on the number of members of JV or Consortium or Association may be prescribed in BDS, in accordance with the guidelines issued by the PPRA).*

3.5 The invitation for Bids is open to all prospective suppliers, manufacturers, or authorized agents / dealers subject to any provisions of incorporation or licensing by the respective national incorporating agency or statutory body established for that particular trade or business. Procuring agencies shall specify the registration/licensing requirements for the foreign bidders keeping in view the requirement of that business.

3.6 A Bidder shall not have a conflict of interest. All Bidders found to have a conflict of interest shall be disqualified. A Bidder may be considered to have a conflict of interest with one or more parties in this Bidding process, if they:

1. are associated or have been associated in the past, directly or indirectly with a firm or any of its affiliates which have been engaged by the Procuring Agency to provide consulting services for the preparation of the design, specifications and other documents to be used for the procurement of the Goods to be purchased under this Invitation for Bids.
2. have controlling shareholders in common; or
3. receive or have received any direct or indirect subsidy from any of them; or
4. have the same legal representative for purposes of this Bid; or
5. have a relationship with each other, directly or through common third parties, that puts them in a position to have access to information about or influence on the Bids of another Bidder, or influence the decisions of the Procuring Agency regarding this Bidding process; or
6. Submit more than one Bid in this Bidding process.

3.7 A Bidder may be ineligible if –

1. he is declared bankrupt or, in the case of company or firm, insolvent;
2. payments in favor of the Bidder is suspended in accordance with the judgment of a court of law other than a judgment declaring bankruptcy and resulting (in accordance with the national laws) in the total or partial loss of the right to administer and dispose of its property;

3. the Bidder is convicted, by a final judgment, of any offence involving professional conduct;

4. the Bidder is blacklisted locally or by international organizations and hence debarred due to involvement in corrupt and fraudulent practices, or performance failure or due to breach of Bid securing declaration.

3.8 As and when required, bidders shall provide to the Procuring Agency evidence of their eligibility, proof of compliance with the necessary legal requirements to carry out the contract effectively.

3.9 Bidders shall submit Bids relating to the nature, conditions and modalities of sub-contracting wherever the sub-contracting of any elements of the contract amounting to more than ten (10) percent of the Bid price is envisaged.

## 4. Eligible Goods and Related Services

4.1 All goods and related services to be supplied under the contract shall have their origin in eligible source countries, and all expenditures made under the contract will be limited to such goods and services. For purpose of this Bid, ineligible countries are the countries declared ineligible by the Federal Government.

## 5. One Bid per Bidder

5.1 A bidder shall submit only one Bid, in the same bidding process, either individually as a Bidder or as a member in a joint venture or any similar arrangement.

5.2 The Bidder shall not engage a subcontractor for any portion of the contract if the value of such subcontracting exceeds thirty percent (30%) of the total contract amount.

## 6. Cost of Bidding

6.1 Any cost incurred by the bidder relating to the preparation and submission of its Bid shall be borne by the bidder, and the Procuring Agency shall in no case be responsible or liable for those costs, regardless of the conduct or outcome of the bidding process.

## B. Bidding Documents

## 7. Contents of Bidding Document

7.1 The Goods required, Bidding procedures, and terms and conditions of the contract are prescribed in the Bidding Documents. In addition to the Invitation for Bids, the Bidding documents which should be read in conjunction with any addenda issued in accordance with **ITB 9.1** include:

**Section I** -Invitation to Bids

**Section II** Instructions to Bidders (ITB)

**Section III** Bid Data Sheet (BDS)

**Section IV** Evaluation Criteria, Specifications, Schedule of Requirements

**Section V** Bid Forms

**Section VI** General Conditions of Contract (GCC)

**Section VII** Special Conditions of Contract (SCC)

**Section VIII** Contract Forms

7.2 The Bidder is expected to examine all instructions, forms, terms and specifications in the Bidding documents. Failure to furnish all the information required in the Bidding documents through **EPADS v2.0** will be at the Bidder's risk and may result in the rejection of his Bids.

## 8. Clarification of Bidding documents

8.1 A prospective Bidder requiring any clarification of the Bidding documents may notify the Procuring Agency through **EPADS v2.0**.

8.2 The Procuring Agency will within three (3) working days after receiving the request for clarification, respond to any request for clarification through **EPADS v2.0** provided that such request is received not later than three (03) days prior to the deadline for the submission of Bids as prescribed in **ITB 22**

8.3 Copies of the Procuring Agency's response will be forwarded to all identified Prospective Bidders through **EPADS v2.0**, including a description of the inquiry, but without identifying its source.

8.4 Should the Procuring Agency deem it necessary to amend the Bidding document as a result of a clarification, it shall do so following the procedure under **ITB 9**.

8.5 If indicated **in the BDS**, the Bidder's designated representative is invited at the Bidder's cost to attend a pre-Bid meeting at the place, date and time mentioned **in the BDS**. During this pre-Bid meeting, prospective Bidders may request clarification of the schedule of requirement, the Evaluation Criteria or any other aspects of the Bidding document.

8.6 Minutes of the pre-Bid meeting, if applicable, including the text of the questions asked by Bidders, including those during the meeting (without identifying the source) and the responses given, together with any responses prepared after the meeting will be uploaded on **EPADS v2.0**. Any modification to the Bidding documents that may become necessary as a result of the pre-Bid meeting shall be made by the Procuring Agency exclusively through the use of an Addendum pursuant to **ITB 9**. Non-attendance at the pre-Bid meeting will not be a cause for disqualification of a Bidder.

## 9. Amendment of Bidding documents

9.1 Before the deadline for submission of Bids, the Procuring Agency for any reason, whether at its own initiative or in response to a clarification requested by a prospective Bidder or Pre-Bid meeting may modify the Bidding documents by issuing addenda through **EPADS v2.0**.

9.2 The Procuring Agency shall promptly publish the addendum through **EPADS v2.0**.

9.3 Any addendum issued including the notice of any extension of the deadline shall also be communicated through EPADS v2.0 to all the bidders who have already submitted their bids. Such bidders shall have the right to withdraw their already submitted bid and re-submit the revised bid prior to the original or extended bid submission deadline.

9.4 To give prospective Bidders reasonable time in which to take an addendum/corrigendum into account in preparing their Bids, the Procuring Agency may, at its discretion, extend the deadline for the submission of Bids through **EPADS v2.0**:

Provided that the Procuring Agency shall extend the deadline for submission of Bids, if such an addendum is issued within last three (03) days of the Bids submission deadline.

## C. Preparation of Bids

## 10. Language of Bid

10.1 The Bid prepared by the bidder, as well as all correspondence and documents relating to the Bids exchanged by the Bidder and the Procuring Agency shall be written in the English language unless otherwise specified in the BDS. Supporting documents and printed literature furnished by the Bidder may be in another language provided they are accompanied by an accurate translation of the relevant pages in the English language unless otherwise specified in the **BDS**, in which case, for purposes of interpretation of the Bidder, the translation shall govern.

## 11. Documents and samples Constituting the Bid

**11.1 The Bid prepared by the Bidder shall constitute** the documents required in the **BDS**.

Details of sample(s) where applicable and requested in the BDS.

1. Documentary evidence established in accordance with ITB that the Bidder is eligible and/or qualified for the subject bidding process;
2. Documentary evidence establish that the Bidder has been authorized by the manufacturer to deliver the goods into Pakistan, where required and where the supplier is not the manufacturer of those goods;
3. Documentary evidence establish that the goods and related services to be supplied by the Bidder are eligible goods and services, and conform to the Bidding Documents;
4. Bid security or Bid Securing Declaration furnished in accordance with **ITB 18**.

## 12. Documents Establishing Eligibility of the Goods and Conformity to Bidding documents

**12.1** To establish the conformity of the bidder to the Bidding document, the Bidder shall furnish as part of its Bids the documentary evidence that Goods provided conform to the technical specifications and standards.

## 13. Documents Establishing Eligibility and Qualification of the Bidder

**13.1** The Bidder shall furnish, as part of its Bid, all those documents establishing the Bidder's eligibility to participate in the Bidding process and/or its qualification to perform the contract if its Bid is accepted.

## 14. Form of Bids

**14.1** The Bidder shall fill the Form of Bid furnished in the Bidding documents. The Bids Form must be completed without any alterations to its format and no substitute shall be accepted.

## 15. Bids Prices

15.1 The Bids Prices quoted by the Bidder in the Form of Bid and in the Price Schedules shall conform to the requirements specified below or exclusively mentioned hereafter in the Bidding documents.

15.2 All items in the Schedule of Requirement must be listed and priced separately in the Price Schedule(s). If a Price Schedule shows items listed but not priced and neither explicitly denied, their prices shall be construed to be included in the prices of other items.

15.3 Items not listed in the Price Schedule shall be assumed not to be included in the Bid, and provided that the Bid is still substantially responsive in their absence or due to their nominal nature, the corresponding average price of the respective item(s) of the remaining substantially responsive Bidder(s) shall be construed to be the price of those missing item(s)

15.4 The Bid price to be quoted in the Form of Bid in accordance with **ITB 14.1** shall be the total price of the Bid.

15.5 The Bidder shall indicate on the appropriate Price Schedule, the unit prices (where applicable) and total Bid price of the Goods it proposes to provide under the contract.

15.6 Prices quoted by the Bidder shall be fixed during the Bidder's performance of the contract and not subject to variation on any account. A Bid submitted with an adjustable price will be treated as non-responsive and shall be rejected.

## 16. Bids Currencies

16.1 Prices shall be quoted in Pakistani Rupees unless otherwise specified in the BDS in accordance with Rule 30 (2) of the Public Procurement Rules, 2004.

## 17. Bids Validity Period

17.1 Bids shall remain valid for the period specified in the **BDS** after the Bid submission deadline prescribed by the Procuring Agency. A Bid valid for a shorter period shall be rejected by the Procuring Agency as non-responsive. The period of Bid validity will be determined from the complementary Bid securing instrument, i.e. the expiry period of Bid Security or Bids Securing Declaration as the case may be.

17.2 The procuring agency shall ordinarily be under an obligation to process and evaluate the bid and to issue letter of award within the stipulated bid validity period.

17.3 Under exceptional circumstances, prior to the expiration of the initial Bid validity period, the Procuring Agency may request the Bidders' consent to an extension of the period of validity of their Bids only once through **EPADS v2.0**, for the period not more than the period of initial bid validity. The Bid Security provided under **ITB 18** shall also be suitably extended. A Bidder may refuse the request without forfeiting its Bid security or causing to be executed its Bid Securing Declaration. A Bidder agreeing to the request will not be required nor permitted to modify its Bid, but will be required to extend the validity of its Bid Security or Bid Securing Declaration for the period of the extension.

## 18. Bid Security or Bid Securing Declaration

18.1 The Bidder shall furnish as part of its Bid, a Bid Security in accordance with Rule 25 of the Public Procurement Rules, 2004.

18.2 The original Bid Security shall be enclosed within the sealed envelope and to be submitted physically before closing time for submission of bids. Whereas, scanned copy of bid security shall be uploaded electronically through EPADS v2.0 before closing hours for submission of bids.

18.3 The Bidder who failed to submit the original Bids security before the submission deadline shall be disqualified straightaway.

18.4 The Bid Security or Bid Securing Declaration is required to protect the Procuring Agency against the risk of Bidder's conduct which would warrant the security's forfeiture, pursuant to **ITB 18.7**.

18.5 The Bid Security shall be denominated in the local currency, and it shall be a Bank Draft in the name of the Procuring Agency and valid for twenty-eight (28) days beyond the end of the validity of the Bid. This shall also apply if the period

for Bids/Bid Validity is extended. In either case, the form must include the complete name of the Bidder.

18.6 The Bid Security shall be payable promptly upon written demand by the Procuring Agency in case any of the conditions listed in **ITB 18** are invoked.

18.7 Unsuccessful Bidders' Bid Security will be discharged or returned as promptly as possible, however in no case later than thirty (30) days after the expiration of the period of Bids Validity prescribed by the Procuring Agency pursuant to **ITB 17**. The Procuring Agency shall make no claim to the amount of the Bid Security, and shall promptly return the Bid Security document, after whichever of the following that occurs earliest:

- a. the expiry of the Bid Security;
- b. the entry into force of a procurement contract and the provision of a Performance Guarantee, for the performance of the contract if such a guarantee, is required by the Bid documents;
- c. the rejection by the Procuring Agency of all Bids;
- d. the withdrawal of the Bids prior to the deadline for the submission of Bids, unless the Bids documents stipulate that no such withdrawal is permitted.

18.8 The successful Bidder's Bids Security will be discharged upon the Bidder signing the contract, or furnishing the Performance Guarantee.

18.9 The Bid Security may be forfeited or the Bid Securing Declaration executed:

- a. if a Bidder:
- b. withdraws its Bid during the period of Bid Validity as specified by the Procuring Agency, and referred by the Bidder on the Form of Bids except as provided for in **ITB 17.2**; or
- c. does not accept the correction of errors; or
- d. in the case of a successful Bidder, if the Bidder fails:
- e. to sign the contract; or
- f. to furnish Performance Guarantee.

## 19. Withdrawal, Substitution, and Modification of Bid

19.1 Before Bid submission deadline, any Bidder may withdraw, substitute, or modify its Bid after it has been submitted through EPADS v2.0. Bids requested to be withdrawn, shall be returned unopened to the Bidders through **EPADS v2.0**.

## 20. Format and Signing of Bid

20.1 The Bidder shall prepare and submit Bids with due diligence after carefully reading all the terms and condition **before bid submission deadline** through EPADS v2.0.

## D. Submission of Bids

### 21. Submission of Bids through EPADS v2.0

21.1 The Technical and Financial Bids if required to submitted, shall be submitted on **EPADS v2.0**.

### 22. Deadline for Submission of Bids

22.1 Bids shall be received by the Procuring Agency through **EPADS v2.0** before bid submission deadline.

22.2 The Procuring Agency may, under exceptional circumstances, extend the deadline for the submission of Bids, after recording reasons in writing and in an equal opportunity manner.

In such case, all rights and obligations of the Procuring Agency and the Bidders that were previously governed by the original deadline shall thereafter be subject to the revised deadline.

## E. Opening and Evaluation of Bids

### 23. Opening of Bids

23.1 The Bid Evaluation Committee of the Procuring Agency shall open all Bids through the EPADS v2.0, on the date and time specified in the Bid Data Sheet (BDS).

23.2 The Bid Evaluation Committee **shall generate minutes through EPADS v2.0 containing brief details of bid opening process.** The record of the Bid opening shall include, as a minimum: the name of the Bidder, the Bid price if applicable, and the presence or absence of a Bid Security or Bid Securing Declaration.

23.3 The procuring agency shall live broadcast the opening of bids on national media or on their website or digital channels, if the volume of procurement exceeds five hundred million rupees in case of goods and services and one thousand million rupees in case of works.

23.4 In case the date of opening of bid has been declared as public holiday or the procuring agency fail to open bid due to any EPADS v2.0 related issues, the submission and opening of bids shall be shifted to the next working day on the same time.

23.5 In case of Single Stage One Envelope Procedure, the Bidders names, the Bid prices, the total amount of each Bid and, the presence or absence of Bid Security, Bid Securing Declaration and such other details as the Procuring Agency may consider appropriate, will be announced by the Bid Evaluation Committee.

## 24. Clarification of Bids

24.1 To assist in the examination, evaluation and comparison of Bids of the Bidders, the Procuring Agency may, ask any Bidder for a clarification of its Bid including breakdown of prices.

24.2 The request for clarification and the response shall be sought through EPADS v2.0 **before three days prior to the deadline for submission of bids.** No change in the prices or substance of the Bids shall be sought, offered, or permitted.

24.3 The alteration or modification in the BIDS which in any way affect the following parameters will be considered as a change in the substance of a Bids:

1. evaluation & qualification criteria;
2. required scope of work or specifications;
3. all securities requirements;
4. tax requirements;

5. terms and conditions of Bidding documents.

6. change in the ranking of the Bidder

24.4 From the time of Bids opening to the time of Contract award if any Bidder wishes to contact the Procuring Agency on any matter related to the Bids it should do so through **EPADS v2.0**.

## 25. Preliminary Examination of Bids

25.1 Prior to the detailed evaluation of Bids, the Procuring Agency will determine whether each Bid:

1. meets the eligibility criteria defined in **ITB 3**;
2. has been prepared as per the format and contents defined by the Procuring Agency in the Bidding documents;
3. is accompanied by the required securities; and
4. is substantially responsive to the requirements of the Bidding documents.

25.2 The Procuring Agency's determination of a Bid's responsiveness will be based on the contents of the Bid itself.

25.3 A substantially responsive Bid is one which conforms to all the terms, conditions, and specifications of the Bidding documents, without material deviation or reservation. A material deviation or reservation is one that: -

1. affects in any substantial way the scope, quality, or performance of the Goods;
2. limits in any substantial way, inconsistent with the Bidding documents, the Procuring Agency's rights or the Bidders obligations under the Contract; or
3. if rectified, would affect unfairly the competitive position of other Bidders presenting substantially responsive Bids.

25.3 If a Bids is not substantially responsive, it will be rejected by the Procuring Agency and may not subsequently be evaluated for complete technical responsiveness.

## 26. Examination of Terms and Conditions; Technical Evaluation

26.1 The Procuring Agency shall examine the Bids to confirm that all terms and conditions specified in the **GCC** and the **SCC** have been accepted by the Bidder without any material deviation or reservation.

26.2 The Procuring Agency shall evaluate the technical aspects of the Bids submitted, to confirm that all requirements specified in Schedule of Requirements and Technical Specifications of the Bidding documents have been met without material deviation or reservation.

26.3 If after the examination of the terms and conditions and the technical evaluation, the Procuring Agency determines that the Bid is not substantially responsive in accordance with **ITB 25.2**, it shall reject the Bid.

## 27. Correction of Errors

27.1 Bids determined to be substantially responsive will be checked for any arithmetic errors. Errors will be corrected as follows: -

1. if there is a discrepancy between unit prices and the total price that is obtained by multiplying the unit price and quantity, the unit price shall prevail, and the total price shall be corrected, unless in the opinion of the Procuring Agency there is an obvious misplacement of the decimal point in the unit price, in which the total price as quoted shall govern and the unit price shall be corrected;
2. if there is an error in a total corresponding to the addition or subtraction of sub-totals, the sub-totals shall prevail and the total shall be corrected; and
3. where there is a discrepancy between the amounts in figures and in words, the amount in words will govern.
4. Where there is discrepancy between grand total of price schedule and amount mentioned on the Form of Bids, the amount referred in Price Schedule shall be treated as correct subject to elimination of other errors.

27.2 The amount stated in the Bid will, be adjusted by the Procuring Agency in accordance with the above procedure for the correction of errors and, with the concurrence of the Bidder, shall be considered as binding upon the Bidder. If the Bidder does not accept the corrected amount, its Bid will then be rejected, and the Bid Security may be forfeited or the Bids Securing Declaration may be executed.

## 28. Conversion to Single Currency

28.1 To facilitate evaluation and comparison, the Procuring Agency will convert all Bids prices expressed in the amounts in various currencies in which the Bids prices are payable. For the purposes of comparison of bids quoted in different currencies, the price shall be converted into a single currency specified in the bidding documents. The rate of exchange shall be the selling rate prevailing on the date of opening of financial bids specified in the bidding documents, in accordance with weighted average customer exchange rates list issued by the State Bank of Pakistan on that day.

## 29. Evaluation of Bids

29.1 The Bids, quotations, or proposals shall be evaluated by the respective evaluation committees as per evaluation criteria described in the Bidding Documents in accordance with Rule 29 and 30 of the Public Procurement Rules, 2004.

### **1. Least Cost Based Selection (LCBS)**

After meeting the requirements of eligibility, qualification and substantial responsiveness, the bid in compliance with all the mandatory (technical) specifications/requirements and/or requisite quality threshold (if any), and having lowest evaluated cost (or financial proposal) shall be considered Successful Bid.

### **2. Quality and Cost Based Selection (QCBS)**

In such combination, there shall be some specific weightage of both the technical features and financial aspects of the proposal. The financial marks shall be awarded on the basis of inverse proportion calculations. The successful bid shall be declared, on the basis of combined evaluation.

### **3. Quality Based Selection (QBS)**

After meeting the requirements of eligibility, qualification and substantial responsiveness the bid in compliance with all the mandatory (technical) specifications/requirements and attaining highest marks in the Technical Evaluation considering all other qualitative and/or quantitative parameters (or point rated criteria) for technical proposal(s) such as working methodology, implementation plan, resource allocation, additional functionalities, risk management approach, knowledge transfer techniques, post implementation methodology etc. shall be treated as highest ranked bid. Later on, the financial proposal of highest ranked bidder shall be opened, however, in case of failure to proceed further with such a bidder, the procuring agency may resort to second

highest bidder and so on.

29.2 In case of tie of bids, the bidders shall be provided an opportunity to offer their best and final monetary offer through EPADS v2.0. However, in no case the rates shall be higher than the original financial bids.

## 30. Domestic Preference

30.1 The procuring agency shall evaluate and compare bids, allow for preference to domestic bidders, while competing with the international bidders in accordance with the policies of Federal Government.

The percentage of preference, to be accorded shall be clearly mentioned in the bidding documents under the bid evaluation criteria.

## 31. Determination of Successful Bid

31.1 Selection technique will be adopted for determining the Successful Bid in accordance with the criteria referred in the BDS or prescribed in the separate section titled as Evaluation Criteria.

31.2 In case where the Procuring Agency adopts the Cost Based Evaluation Technique and, the Bid with the lowest evaluated price from amongst those which are eligible, compliant and substantially responsive shall be the Successful Bid.

31.3 The Procuring Agency may adopt the Quality & Cost Based Selection Technique due to the following two reasons:

1. Where the Procuring Agency knows about the main features, usage and output of the products; however not clear about the complete features, technical specifications and functionalities of the goods to be procured and requires the bidders to submit their proposals defining those features, specifications and functionalities; or

2. Where the Procuring Agency, in addition to the mandatory requirements and mandatory technical specifications, requires parameters specified in Evaluation Criteria to be evaluated while determining the quality of the goods.

31.4 In such cases, the Procuring Agency may allocate certain weightage to these factors as a part of Evaluation Criteria, and may determine the ranking of the bidders on the basis of combined evaluation in accordance with provisions of Rule 2(1)(h) of the Public Procurement Rules, 2004.

## 32. Abnormally Low Financial Bids

32.1 Where the Bid price is considered to be abnormally low, the Procuring Agency shall perform price analysis either during determination of Successful Bids or as a part of the post-qualification process.

32.2 The Procuring Agency may reject an Abnormally low financial bids.

32.3 In order to identify the Abnormally Low Bids (ALB) following approaches can be considered to minimize the scope of subjectivity:

1. Comparing the Bids price with the cost estimate;
2. Comparing the Bids price with the Bids offered by other Bidders submitting substantially responsive Bids; and
3. Comparing the Bids price with prices paid in similar contracts in the recent past either government- or development partner-funded.

32.4 The Procuring Agency will determine to its satisfaction whether the Bidder that is selected as having submitted the successful bid is qualified to perform the contract satisfactorily.

32.5 The determination will take into account the Bidder's financial, technical, and production capabilities. It will be based upon an examination of the documentary evidence of the Bidder's qualifications submitted by the Bidder, as well as such other information as the Procuring Agency deems necessary and appropriate. Factors not included in these Bidding documents shall not be used in the evaluation of the Bidders' qualifications.

32.6 Procuring Agency may seek "Certificate for Independent Price Determination" from the Bidder and the results of reference checks may be used in determining an award of contract.

Explanation: The Certificate shall be furnished by the Bidder. The Bidder shall certify that the price is determined keeping in view of all the essential aspects such as raw material, its processing, value addition, optimization of resources due to economy of scale, transportation, insurance and margin of profit etc.

32.7 An affirmative determination will be a prerequisite for award of the contract to the Bidder. A negative determination will result in rejection of the Bidder's Bids, in which event the Procuring Agency will proceed to the next ranked Bidder to make a similar determination of that Bidder's capabilities to

perform satisfactorily.

## F. Award of Contract

### 33. Criteria of Award

33.1 The Procuring Agency will award the Contract to the Bidder whose Bids has been determined to be substantially responsive to the Bidding documents and who has been declared as Most Advantageous Bidder.

### 34. Negotiations

34.1 The procuring agency shall not engage in negotiations with respect to scope and price with the bidder except when the procuring agency conducts a procurement using direct **or negotiated** contracting or a request for proposals with evaluation based on quality alone.

34.2 The procuring agency may negotiate with the most advantageous bid with a view to streamline the work or task execution, at the time of contract finalization on methodology, work plan, staffing, finalizing payment arrangements, delivery arrangements, minor amendments to the special conditions of the contract.

### 35. Procuring Agency Right to reject all bids

35.1 The Procuring Agency reserves the right to reject all bids or proposals at any time prior to the issuance of the Letter of Award, without incurring any liability, in accordance with Rule 33 of the Public Procurement Rules, 2004.

### 36. Procuring Agency's Right to Vary Quantities at the Time of Award

36.1 The Procuring Agency reserves the right at the time of contract award to increase or decrease the **quantity of** Goods originally specified in these Bidding documents provided this does not exceed **by** 15%, without any change in unit price or other terms and conditions of the Bids and Bidding documents.

### 37. Notification of Award

37.1 Prior to the award of contract, the procuring agency shall announce and publish the result of bid evaluation on **EPADS v2.0** in accordance with Rule 35

of the Public Procurement Rules, 2004.

37.2 The Bidder whose Bids has been accepted will be notified of the award by the Procuring Agency prior to expiration of the Bids/Bid Validity period. The Letter of Award will state the sum that the Procuring Agency will pay the successful Bidder in consideration for the delivery of Goods as prescribed by the Contract (hereinafter and in the Contract called the "Contract Price).

37.3 The Letter of award will constitute the formation of the Contract, subject to the Bidder furnishing the Performance Guarantee and signing of the contract.

## 38. Signing of Contract

38.1 Promptly after issuance of Letter of award, Procuring Agency shall send the successful Bidder the draft Contract, incorporating all terms and conditions as agreed by the parties to the contract.

38.2 Immediately after the Redressal of grievance by the GRC (if any), mandatory standstill period in accordance with Rule 35 of the Public Procurement Rules, 2004 and **after fulfillment of all condition's precedent** of the Contract Form, the successful Bidder and the Procuring Agency shall sign the Contract.

## 39. Corrupt & Fraudulent Practices

39.1 Procuring Agencies (including beneficiaries of Government funded projects and procurement) as well as Bidders/Contractors under Government financed contracts, observe the highest standard of ethics during the procurement and execution of such contracts, and will avoid to engage in any corrupt and fraudulent practices.

## F. Grievance Redressal & Complaint Review Mechanism

### 40. Constitution of Grievance Redressal

40.1 The Grievance Redressal Committee shall address the grievance, if any submitted by any party, including the bidder, in accordance with Rule 48 of the Public Procurement Rules, 2004 to be read with Redressal of Grievances Regulations, 2021.

40.2 In case if any party or the bidder is not satisfied with the decision of the GRC or if it fails to decide within ten days, the bidder or the party may file an appeal before the Appellate Committee of the Authority in accordance with Rule 48 of the Public Procurement Rules, 2004 to be read with Redressal of Grievances Regulations, 2021.

## G. Mechanism of Blacklisting

### 41. Mechanism of Blacklisting

41.1 The Procuring Agency shall initiate blacklisting proceedings against any bidder, supplier, or contractor in accordance with the Mechanism for Blacklisting Regulations, 2024, read with Rule 19 of the Public Procurement Rules, 2004.

41.2 The blacklisted/debarred bidder may file the review petition before the Authority in accordance with Rule 19 of the Public Procurement Rules, 2004 to be read with Procedure of filing and disposal of Review Petitions Regulations, 2021.





## Bid Data Sheet

# Bids Data Sheet (BDS)

The following specific data for the procurement of Goods to be procured shall complement, supplement, or amend the provisions in the Instructions to Bidders (ITB). Whenever there is a conflict, the provisions herein shall prevail over those in ITB.

*BDS Clause Number*

*ITB Number*

*Amendments of, and Supplements to, Clauses in the Instruction to Bidders*

## A. Introduction

**BDS Clause Number 1**

**ITB Number 1.1**

Name of Procuring Agency: **Islamabad Electric Supply Company (IESCO) (Material Management Directorate)**

The subject of procurement is: **Procurement of Single Phase AMI Meter with GPRS (2G/4G) Communication Module**

Expected commencement date: **Tuesday, November 10, 2026**

**BDS Clause Number 2**

**ITB Number 2.1**

Financial year for the operations of the Procuring Agency: **2026-27**

Name and identification number of the Contract: **P54704**

**BDS Clause Number 3**

**ITB Clause Number 3.1**

JV/Consortium or Association Allowed: **Yes**

Number of JV/Consortium Members: **2**

*see section of eligibility criteria.*

## B. Bidding Documents

**BDS Clause Number 4**

**ITB Number 8.1**

The Bidders may seek clarifications through **EPADS v2.0** : Clarification Date: Friday, July 17, 2026

Pre-Bid Meeting: Thursday, July 9, 2026 11:00 AM

Venue: O/o Chief Engineer (MM), IESCO Headquarters, Street # 40, Sector G-7/4., Islamabad Capital Territory

## C. Preparation of Bids

### **BDS Clause Number 5**

#### **ITB Number 10.1**

The Language of all correspondences and documents related to the Bids shall be in: **English**

List of documents required along with the bid:

1. Previous performance/appraisal of the bidder or supply record of the product supplied by them.
2. Integrity Pact (No contract amount should be mentioned) at time of bid submission. However, if contract award, the Integrity Pact must be submitted for the contract amount exceeding 10 Million.
3. In case of JV, submission of verifiable copy of JV agreement that forms a joint venture, consortium or association as part of bid.
4. Income tax returns for last three (03) years.
5. Audited Financial Reports of last three (03) years.
6. No Deviation certificates from Commercial terms and technical specification
7. Technical literature, if any along with make and origin of product offered.
8. Declaration of Beneficial Ownership for the contract amount exceeding 50 Million. (as per attached annexure)
9. Technical Data and drawings as per table of requirement, AMI specification and Companion specification provided with BD.
10. Declaration regarding no involvement in litigation case, at the time of bid submission.

11. Deceleration that bid conforms to tender conditions and laid down specifications.

12. Declaration regarding use of prime material duly signed and stamped by the manufacturer/supplier as per IESCO AMI Specification.

13. Declaration Regarding responsiveness in terms of technical and commercial evaluation.

14. Certifies that the firm is not involved/using scrap or used material since five years or since \_\_\_\_\_(No. of years since in the manufacturing business).

15. If a new firm emerged as a lowest bidder and having no experience of manufacturing AMI / conventional meters, will be awarded with educational/trial order. (new firm must attach copy of registration/prequalification otherwise attach copy of POs)

16. Authority letter of bid signatory.

17. Provide offered meter model no. on firm's letter head duly signed and stamped.

**BDS Clause Number 6**

**ITB Number 11.1**

**Items/Lots and threere related documents:**

*See section items and Lots*

**BDS Clause Number 7**

**ITB Number 12.1**

**Items / Lots Specifications:**

*see section of items specifications.*

**BDS Clause Number 8**

**ITB Number 15.6**

The price shall be **Fixed**.

**BDS Clause Number 9**

**ITB Number 16.1**

Currency of the Bids shall be : **PKR**

**BDS Clause Number 10**

**ITB Number 17.1**

The Bids/Bid Validity period shall be: **120 Days**

**BDS Clause Number 11**

**ITB Number 18.1**

The amount of Bid Security shall be as defined in Bid Security Section for items and lots given in **BDS 6**

The Bid Security shall be in the form of: **Call at Deposit, Bank Guarantee**

## D. Submission of Bids

**BDS Clause Number 12**

**ITB Number 20.1**

Bid shall be submitted online on EPADS v2.0 whereas hard copy of the bid security should be submitted to the following;

**IESCO Headquarters, Street # 40, Sector G-7/4., Islamabad Capital Territory** before bid submission deadline.

Bids that are not submitted on EPADS v2.0 shall be disqualified.

The deadline for Bids submission is: **Wednesday, July 22, 2026 10:30 AM**

## E. Opening and Evaluation of Bids

**BDS Clause Number 13**

**ITB Number 23.1**

The Bids opening shall take place on **EPADS v2.0.**

Day : **Wednesday**

Date: **Wednesday, July 22, 2026**

Time : **11:00 AM**

**BDS Clause Number 14**

**ITB Number 31.1**

Selection technique adopted will be: **Least Cost Based Selection (LCBS)**  
see *Evaluation Criteria*

## F. Review of Procurement Decisions

**BDS Clause Number 15**

**ITB Number 41.1**

Grievance against this procurement shall be submitted online on EPADS v2.0.

Arbitrator shall be appointed by mutual consent of the both parties.



## Eligibility Criteria

Bidder's Type	Required Registration
Sole Proprietorship	NADRA CITIZENSHIP (CNIC/NICOP)
Partnership Firm	FBR (NTN)
Company (Private Limited)	FBR (GSTN)
Company (Public Limited)	

Eligibility Criteria	Document
Copy of current renewal of prequalification / Registration for the category M-5 with NTDC/WAPDA/DISCOS.	Yes
Declaration for no blacklisting/debarment from NTDC/WAPDA/DISCOs/GENCOs/Govt. Dept. or any organization (locally or internationally) for both manufacturer and bidder, at the time of submission of bid.	Yes

# Evaluation Criteria

Eligible bidder(s) with substantially responsive bid(s) offering **Least Cost Based Selection (LCBS)** shall be considered for the award of contract(s).

## Least Cost Based Selection (LCBS)

Technical Marks	100
Passing Marks	100
Technical Evaluation Criteria	
The bidder should have an Average annual turnover AATO in the last 3-years equal to one & half (1.5) times of the contract value. In case of JV, lead partner must meet 60% of the required AATO requirement and other partners must meet 40% of the requirement. (Quantitative)(Doc Required)	15
The net financial resources should be at least 50% of the contract value (after subtracting the current commitments/liabilities). In case of JV, lead partner must meet 60% of the required financial resources requirement and other partners must meet 40% of the requirement. (Quantitative)(Doc Required)	15
The bidder's net worth during last three (03) years calculated as the difference between total assets and total liabilities should be positive. In case of JV, each partner must meet this requirement. (Quantitative)(Doc Required)	10
Copy of P.Os of the similar nature product i.e. AMI or others conventional meters previously supplied by the bidder/manufacturer. (Quantitative)(Doc Required)	10
Production Capability/Capacity, to meet the tender requirement as per attached annexure. (Quantitative)(Doc Required)	10

Manufacturing experience of at least 2-years or more for similar products i.e. AMI /conventional meters. (Quantitative) (Doc Required)	10
Contractual / Supply experience of similar nature material i.e. AMI or others conventional meters for at least one year or more. (Quantitative)(Doc Required)	10
All pending litigation, arbitration or other material events impacting the net worth and/or liability of the bidder, is any, shall be treated as resolved against the bidder and so shall in total not represent more than 50% of the bidder's net worth. In case of JV, each partner must meet this requirement. (Quantitative)(Doc Required)	10
Possession of valid prototype approval at the time of submission of bid. Prototype approval or type test report will be attached at time of bid submission. In case, bidder fails to provide valid prototype approval, then bidder will provide undertaking to carry out fresh prototype testing without effecting the delivery period on bidder cost and arrangement duly witness by (02) IESCO engineers. The type test can be conducted at the place of manufacturer's lab, and other lab (if required) as per IESCO standards. The requisite process of type test already described in bidding document. If meter is manufactured local, type test can be carried out locally from any IEC/IEEE registered lab. In other case, if meter is manufactured abroad, type test will be carried out abroad. (Quantitative)(Doc Required)	10

# Items/Lots

## Items Without Lots :

Item	UNSPSC	Delivery Schedule	Quantity	Bid Security	Manufacturer / Dealer Authorization	Warranty
Single Phase AMI Meter with GPRS (2G/4G) Communication Module	Power meters	<b>Address:</b> IESCO Regional Store Rawalpindi/Islamabad/Rajjar/Wah. <b>Schedule:</b> As described in Schedule of Requirements. <b>Quantity:</b> 58333/No.	58333/No.	15738000 PKR	Manufacturer Authorization form	24 Months
Single Phase AMI Meter with GPRS (2G/4G) Communication Module	Power meters	<b>Address:</b> IESCO Regional Store Rawalpindi/Islamabad/Rajjar/Wah. <b>Schedule:</b> As described in Schedule of Requirements <b>Quantity:</b> 58333/No.	58333/No.	15738000 PKR	Manufacturer Authorization form	24 Months
Single Phase AMI Meter with GPRS (2G/4G) Communication Module	Power meters	<b>Address:</b> IESCO Regional Store Rawalpindi/Islamabad/Rajjar/Wah. <b>Schedule:</b> As described in Schedule of Requirements <b>Quantity:</b> 58334/No.	58334/No.	15738500 PKR	Manufacturer Authorization form	24 Months

Related Services of Goods:

No



# Items/Lot Specification

## Items Without Lots :

**Item:** Single Phase AMI Meter with GPRS (2G/4G) Communication Module

**UNSPSC:** Power meters

### Specifications / Requirements:

IESCO Own AMI Specifications.

---

**Item:** Single Phase AMI Meter with GPRS (2G/4G) Communication Module

**UNSPSC:** Power meters

### Specifications / Requirements:

IESCO Own AMI Specifications.

---

**Item:** Single Phase AMI Meter with GPRS (2G/4G) Communication Module

**UNSPSC:** Power meters

### Specifications / Requirements:

IESCO Own AMI Specifications.

---

# Price Schedule

## For Individual Items

#	Item Title	Quantity	Unit Price (PKR)	Total Price (PKR)	Delivery Location	Delivery Period / Year	Country of Origin
1							
2							

## For Lots

#	Lot Title	Total Lot Price (PKR)	Country of Origin
1	[Lot 1 Title]		





## General Conditions of Contract

## A. General

### 1. Definitions

1.1 Unless the context otherwise requires, the following terms whenever used in this Contract shall have the same meaning and shall be interpreted as indicated

- a. "Applicable Law" means the laws and any other instruments having the force of law in the Government's Country, or in such other country as may be specified in the Special Conditions of the Contract (SC), as they may be issued and in force from time to time;
- b. "Procuring Agency" means:-
  - a. any Ministry, Division, Department or any Office of the Government;
  - b. any authority, corporation, body or organization established by or under a Law or which is owned or controlled by the Government;
- c. "The Contract" means an agreement enforceable by law;
- d. "The Contract Price" means the price payable to the Bidder under the Contract for the full and proper performance of its contractual obligations;
- e. "Ancillary Services" means those services ancillary to the provision of Goods, such as transportation and insurance, and any other incidental services, such as installation, commissioning, provision of technical assistance, training, and other such obligations of the Bidder covered under the Contract;
- f. "GCC" means the General Conditions of Contract contained in this section;
- g. "SCC" means the Special Conditions of Contract by which the GCC may be amended or supplemented;
- h. "Day" means calendar day unless indicated otherwise.
- i. "Effective Date" means the date on which this Contract comes into force and effect.
- j. "The Bidder" means the individual or corporate body whose Bids to provide the Goods has been accepted by the Procuring Agency;
- k. "The Project Site," where applicable, means the place or places named in Bids Data Sheet and technical Specifications;
- l. "Government" means the Government of Pakistan;
- m. "Subcontractor" means any entity to which the Bidder subcontracts any part of the Goods.
- n. "Service" means any object of procurement other than goods or works;
- o. "Party" means the Procuring Agency or the Bidder, as the case may be, and "Parties" means both of them;
- p. "Foreign Currency" means any currency other than the currency of the country of the Procuring Agency;

q. “Completion Date” means the date of completion of the contract by the Bidder as certified by the Procuring Agency;

r. “In Writing” means communicated in written form with proof of receipt;

s. “Local Currency” means the currency of Pakistan;

## **2. Application and Interpretation**

2.1 These General Conditions shall apply to the extent that they are not superseded by provisions of other parts of the Contract.

2.2 In interpreting these Conditions of Contract headings and marginal notes are used for convenience only and shall not affect their interpretations unless specifically stated; references to singular include the plural and vice versa; and masculine include the feminine. Words have their ordinary meaning under the language of the Contract unless specifically defined.

## **3. Applicable Law**

3.1 The contract shall be governed and interpreted in accordance with the laws of Pakistan, unless otherwise specified in SCC.

## **4. Governing Language**

4.1 The Contract as well as all correspondence and documents relating to the Contract exchanged between the Bidder and the Procuring Agency, shall be written in the **English language** unless otherwise stated in the SCC. Supporting documents and printed literature that are part of the Contract may be in another language provided these are accompanied by an accurate translation of the relevant passages in English, in which case, for purposes of interpretation of the Contract, this translation shall govern.

## **5. Notices**

5.1 Any notice, request, or consent made pursuant to this Contract shall be in writing and shall be deemed to have been made when delivered in person to an authorized representative of the Party to whom the communication is addressed, or when sent by registered mail, telex, telegram, or facsimile to such Party at the address specified in the SCC.

## **6. Delivery/Location**

6.1 The Goods shall be delivered to such locations as the Procuring Agency may approve and as specified in SCC.

## **7. Authorized Representatives / Authority of Member in charge**

7.1 Any action required or permitted to be taken, and any document required or permitted to be executed, under this Contract by the Procuring Agency or the Bidder may be taken or executed by the officials specified in the SCC.

## **B. Commencement, Completion, Modification, and Termination of Contract**

### **8. Effectiveness of Contract**

8.1 This Contract shall come into effect on the date the Contract is signed by both parties and such other later date as may be stated in the SCC.

## **9. Commencement of Services**

9.1 The Bidder shall confirm availability of Key Experts and begin carrying out the Services not later than the number of days after the Effective Date specified in the SCC.

## **10. Program**

10.1 Before commencement of the Services, the Bidder shall submit to the Procuring Agency for approval a Program showing the general methods, arrangements, order and timing for all activities. The Services shall be carried out in accordance with the approved Program as updated.

## **11. Starting Date/Expiration Date**

11.1 The Bidder shall start carrying out the Services Five (05) days after the date the Contract becomes effective, or at such other date as may be specified in the SCC.

11.2 Unless terminated earlier pursuant to Clause **GCC 15** hereof, this Contract shall expire at the end of such time period after the Effective Date as specified in the SCC.

## **12. Entire Agreement**

12.1 This Contract contains all covenants, stipulations and provisions agreed by the Parties. No agent or representative of either Party has authority to make, and the Parties shall not be bound by or be liable for, any statement, representation, promise or agreement not set forth herein.

## **13. Modification**

13.1 Any modification or variation of the terms and conditions of this Contract, including any modification or variation of the scope of the Services, may only be made by written agreement between the Parties. However, each Party shall give due consideration to any Bids for modification or variation made by the other Party.

13.2 In cases of any modifications or variations, the prior written consent of the Procuring Agency is required.

## **14. Force Majeure**

### **14.1 Definition**

For the purposes of this Contract, "Force Majeure" means an event which is beyond the reasonable control of a Party and which makes a Party's performance of its obligations under the Contract impossible or so impractical as to be considered impossible under the circumstances.

### **14.2 No Breach of Contract**

The failure of a Party to fulfill any of its obligations under the contract shall not be considered to be a breach of, or default under, this Contract in so far as such inability arises from an event of Force Majeure, provided that the Party affected by such an event (a) has taken all reasonable precautions, due care and reasonable alternative measures in order to carry out the terms and conditions of this Contract, and (b) has informed the other Party as soon as possible about the occurrence of such an event.

### **14.3 Extension of Time**

Any period within which a Party shall, pursuant to this Contract, complete any action or task, shall be extended for a period equal to the time during which such Party was unable to perform such action as a result

of Force Majeure.

#### **14.4 Payments**

During the period of their inability to perform the Services as a result of an event of Force Majeure, the Bidder shall be entitled to continue to be paid under the terms of this Contract, as well as to be reimbursed for additional costs reasonably and necessarily incurred by them during such period for the purposes of the Services and in reactivating the Service after the end of such period.

#### **15. Termination**

##### **15.1 By the Procuring Agency**

The Procuring Agency may terminate this Contract in case of the occurrence of any of the events specified in paragraphs (a) through (e) of this Clause. In such an occurrence the Procuring Agency shall give at least thirty (30) calendar days' written notice of termination to the Bidder in case of the events referred to in (a) through (d); at least sixty (60) calendar days' written notice in case of the event referred to in (e);

- a. If the Bidder fails to remedy a failure in the performance of its obligations hereunder, as specified in a notice of suspension;
- b. If the Bidder becomes (or, if the Bidder consists of more than one entity, if any of its members becomes) insolvent or bankrupt or enter into any agreements with their creditors for relief of debt or take advantage of any law for the benefit of debtors or go into liquidation or receivership whether compulsory or voluntary;
- c. If the Bidder fails to comply with any final decision reached as a result of arbitration proceedings;
- d. If, as the result of Force Majeure, the Bidder is unable to perform a material portion of the Services for a period of not less than sixty (60) calendar days;
- e. If the Procuring Agency, in its sole discretion and for any reason whatsoever, decides to terminate this Contract;

##### **15.2 By the Bidder**

The Bidder may terminate this Contract, by not less than thirty (30) calendar days' written notice to the Procuring Agency, in case of the occurrence of any of the events specified in paragraphs (a) through (d) of this Clause.

- a. If the Procuring Agency fails to pay any money due to the Bidder pursuant to this Contract and not subject to dispute within forty-five (45) calendar days after receiving written notice from the Bidder that such payment is overdue.
- b. If, as the result of Force Majeure, the Bidder is unable to perform a material portion of the Services for a period of not less than sixty (60) calendar days.
- c. If the Procuring Agency fails to comply with any final decision reached as a result of arbitration.
- d. If the Procuring Agency is in material breach of its obligations pursuant to this Contract and has not remedied the same within forty-five (45) days (or such longer period as the Bidder may have subsequently approved in writing) following the receipt by the Procuring Agency of the Bidder's notice specifying such breach.

## **C. Obligations of the Bidder**

## **16. General**

### **16.1 Standard of Performance**

1. The Bidder shall deliver the product and carry out the Services with all due diligence, efficiency and economy, in accordance with generally accepted professional standards and practices, and shall observe sound management practices, and employ appropriate technology and safe and effective equipment, machinery, materials and methods. The Bidder shall always act, in respect of any matter relating to this Contract or to the Services, as a faithful adviser to the Procuring Agency, and shall at all times support and safeguard the Procuring Agency's legitimate interests in any dealings with the third parties.

### **16.2 Law Applicable to Goods**

The Bidder shall deliver the goods in accordance with the Contract and in accordance with the Law of Pakistan and shall take all practicable steps to ensure that any of its Experts and Sub-Bidders, comply with the Applicable Law.

## **17. Conflict of Interests**

### **17.1 Bidder Not to Benefit from Commissions and Discounts.**

The remuneration of the Bidder shall constitute the Bidder's sole remuneration in connection with this Contract or the Services, and the Bidder shall not accept for their own benefit any trade commission, discount, or similar payment in connection with activities pursuant to this Contract or to the Services or in the discharge of their obligations under the Contract, and the Bidder shall use their best efforts to ensure that the Personnel, any Subcontractors, and agents of either of them similarly shall not receive any such additional remuneration.

### **17.2 Bidder and Affiliates Not to be Otherwise Interested in Project**

The Bidder agree that, during the term of this Contract and after its termination, the Bidder and its affiliates, as well as any Subcontractor and any of its affiliates, shall be disqualified from providing Goods for any project resulting from or closely related to the Services.

### **17.3 Prohibition of Conflicting Activities**

Neither the Bidder nor its Subcontractors nor the Personnel shall engage, either directly or indirectly, in any of the following activities:

- a. during the term of this Contract, any business or professional activities in the Government's country which would conflict with the activities assigned to them under this Contract;
- b. during the term of this Contract, neither the Bidder nor their Subcontractors shall hire public employees in active duty or on any type of leave, to perform any activity under this Contract;

## **18. Confidentiality**

18.1 Except with the prior written consent of the Procuring Agency, the Bidder and the Experts shall not at any time communicate to any person or entity any confidential information acquired in the course of the contract.

## **19. Insurance to be Taken Out by the Bidder**

19.1 The Bidder(a) shall take out and maintain, and shall cause any Subcontractors to take out and maintain, at its (or the Subcontractors', as the case may be) own cost but on terms and conditions approved by the Procuring Agency, insurance against the risks, loss or damage, and for the coverage, as shall be specified in the SCC; and (b) at the Procuring Agency's request, shall provide evidence to the Procuring Agency showing that such insurance has been taken out and maintained and that the current premiums have been paid.

## **20. Bidder's Actions Requiring Procuring Agency's Prior Approval**

20.1 The Bidder shall obtain the Procuring Agency's prior approval in writing before taking any of the following actions:

- (a) appointing such members of the Personnel not provided by the Bidder;
- (b) changing the Program of activities; and
- (c) any other action that may be specified in the SCC.

## **21. Reporting Obligations**

21.1 The Bidder shall submit to the Procuring Agency the reports and documents in the numbers, and within the periods as prescribed by the Procuring Agency.

## **22. Liquidated Damages**

22.1 If the Supplier fails to deliver any or all of the Goods or to perform the Services within the period(s) specified in the Contract, the Procuring Agency shall, without prejudice to its other remedies under the Contract, deduct from the Contract Price, as liquidated damages, a sum equivalent to the percentage specified in SCC of the delivered price of the delayed Goods or unperformed Services for each week or part thereof of delay until actual delivery or performance, up to a maximum deduction of the performance security (or guarantee) specified in SCC. Once the said maximum is reached, the Procuring Agency may consider termination of the Contract pursuant to **GCC Clause 15**.

### **22.2 Correction for Over-payment**

If the Intended Completion Date is extended after liquidated damages have been paid, the Procuring Agency shall correct any overpayment of liquidated damages by the Bidder by adjusting the next payment certificate. The Bidder shall be paid interest on the overpayment, calculated from the date of payment to the date of repayment, at the rates specified in SCC.

### **22.3 Lack of performance penalty**

If the Bidder has not corrected a Defect within the time specified in the Procuring Agency's notice, a penalty for Lack of performance will be paid by the Bidder. The amount to be paid will be calculated as a percentage of the cost of having the Defect corrected, assessed as specified in the SCC.

## **23. Performance Guarantee**

23.1 Within Seven (07) days from the issuance of acceptance letter from the Procuring Agency, the successful Bidder shall furnish the Performance Guarantee in shape of ----- at the discretion of the PA in the amount **specified in SCC**. In case the amount of Bids security is equal or greater than

23.2 The proceeds of the Performance Guarantee shall be payable to the Procuring agency as compensation for any loss resulting from the Supplier's failure to complete its obligations under the Contract.

23.3 The Performance Guarantee shall be denominated in the currency of the Contract, or in a freely convertible currency acceptable to the Procuring agency and shall be in the acceptable form as specified in SCC.

23.4 The Performance Guarantee will be discharged by the Procuring agency and returned to the Supplier not later than thirty (30) days following the date of completion of the Supplier's performance obligations under the Contract, including any warranty obligations, unless otherwise **specified in SCC**.

## **24. Fraud and Corruption**

24.1 The Procuring Agency requires the Supplier to disclose any commissions or fees that may have been paid or are to be paid to agents or any other party with respect to the Bidding process or execution of the Contract. The information disclosed must include at least the name and address of the agent or other party, the amount and currency, and the purpose of the commission, gratuity or fee.

## **25. Sustainable Procurement**

25.1 The Bidder shall conform to the sustainable procurement contractual provisions, if and as specified in the SCC.

## **D. Bidder's Personnel**

### **26. Description of Personnel**

26.1 The titles, agreed job descriptions, minimum qualifications, and estimated periods of engagement in the carrying out of the Services of the Bidder's Key Personnel. The Key Personnel listed by title as well as by name are hereby approved by the Procuring Agency.

### **27. Removal and/or Replacement of Personnel**

27.1 Except as the Procuring Agency may otherwise agree, no changes shall be made in the Key Personnel. If, for any reason beyond the reasonable control of the Bidder, it becomes necessary to replace any of the Key Personnel, the Bidder shall provide as a replacement a person of equivalent or better qualifications.

27.2 If the Procuring Agency finds that any of the Personnel have (i) committed serious misconduct or have been charged with having committed a criminal action, or (ii) have reasonable cause to be dissatisfied with the performance of any of the Personnel, then the Bidder shall, at the Procuring Agency's written request specifying the grounds thereof, provide as a replacement a person with qualifications and experience acceptable to the Procuring Agency.

27.3 The Bidder shall have no claim for additional costs arising out of or incidental to any removal and/or replacement of Personnel.

## **E. Obligations of the Procuring Agency**

### **28. Assistance and Exemptions**

28.1 The Procuring Agency shall use its best efforts to ensure that the Government shall provide the Bidder such assistance and exemptions as specified in the SCC.

### **29. Change in the Applicable Law**

29.1 If, after the date of this Contract, there is any change in the Applicable Law with respect to taxes and duties which increases or decreases the cost of the related Services rendered by the Bidder, then the remuneration and reimbursable expenses otherwise payable to the Bidder under this Contract shall be increased or decreased accordingly by agreement between the Parties, and corresponding adjustments shall be made to the amounts referred in the SCC.

### **30. Services and Facilities**

30.1 The Procuring Agency shall make available to the Bidder and the Experts, for the purposes of the Services and free of any charge, the services, facilities and property described , at the times and in the manner specified in the SCC or terms of reference.

30.2 In case that such services, facilities and property shall not be made available to the Bidder, the Parties shall agree on (i) any time extension that it may be appropriate to grant to the Bidder for the performance of the Services, (ii) the manner in which the Bidder shall procure any such services, facilities and property from other sources, and (iii) the additional payments, if any, to be made to the Bidder as a result thereof.

## **F. Payments to the Bidder**

### **31. Contract Price**

31.1 The price payable shall be in Pakistani Rupees unless otherwise specified in the SCC. Prices charged by the Supplier for Goods delivered under the Contract shall not vary from the prices quoted by the Supplier in its Bid.

### **32. Terms and Conditions of Payment**

32.1 Payments will be made to the Bidder according to the payment schedule stated in the SCC and as per actual invoice submitted by the Bidder.

32.2 Unless otherwise stated in the SCC, the advance payment shall be made against the provision by the Bidder of a bank guarantee for the same amount, and shall be valid for the period stated in the SCC. Any other payment shall be made after the conditions listed in the SCC for such payment have been met, and the Bidder have submitted an invoice to the Procuring Agency specifying the amount due.

### **33. Currency of Payment**

33.1 Any payment under this Contract shall be made in the currency(ies) specified in the SCC.

## **G. Quality Control**

### **34. Identifying Defects**

34.1 The principle and modalities of Inspection of the Goods by the Procuring Agency shall be as indicated in the SCC. The Procuring Agency shall check the Bidder's performance and notify him of any Defects that are found. Such checking shall not affect the Bidder's responsibilities. The Procuring Agency may instruct the Bidder to search for a Defect and to uncover and test any service that the Procuring Agency considers may have a Defect. Defect Liability Period is as defined in the SCC.

### **35. Correction of Defects, and**

#### **Lack of Performance Penalty**

35.1 The Procuring Agency shall give notice to the Bidder of any Defects before the end of the Contract. The Defects liability period shall be extended for as long as Defects remain to be corrected.

35.2 Every time notice a Defect is given, the Bidder shall correct the notified Defect within the length of time specified by the Procuring Agency's notice.

35.3 If the Bidder has not corrected a Defect within the time specified in the Procuring Agency's notice, the Procuring Agency will assess the cost of having the Defect corrected, the Bidder will pay this amount, and a Penalty for Lack of Performance.

### **36. Taxes and Duties**

36.1 A Supplier shall be entirely responsible for all taxes, duties, fees, etc., incurred until delivery of the contracted Goods to the Procuring Agency.

## **H. Settlement of Disputes**

### **37. Alternate Dispute Resolution**

37.1 The disputes between the parties to the contract may be settled in accordance with Public Procurement Rules, 2004.

37.2 The procuring agency shall refer the matter to the Chief Justice Islamabad High Court or Managing Director PPRA or the Secretary Ministry of Law & Justice for appointment of Arbitrator.

37.3 The fee for the Arbitrator shall be specified in Pak Rupees as determined by the appointing authority which shall be borne and shared equally by the contracting parties.

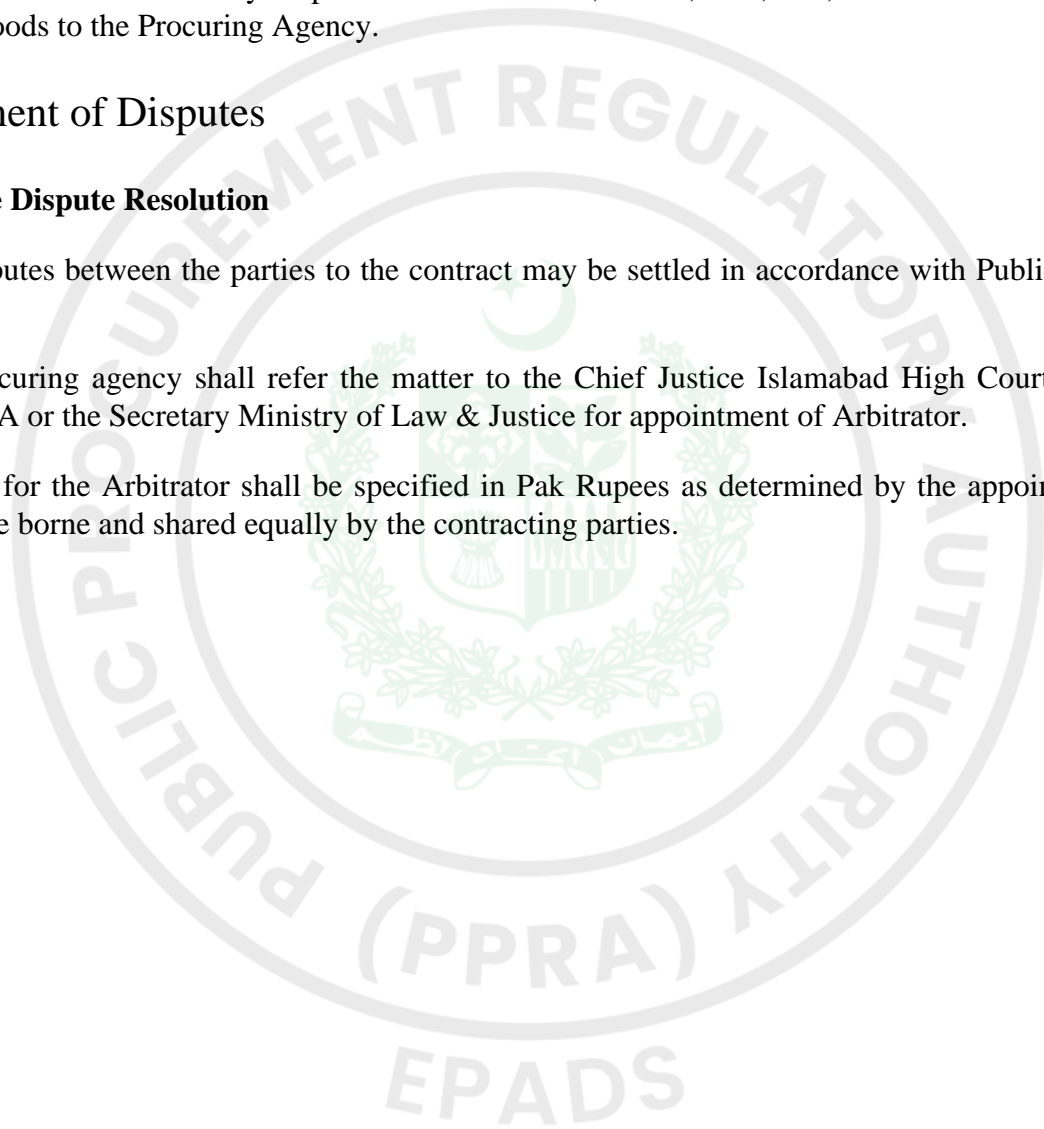



## Special Conditions of Contract

## **SECTION VIII. SPECIAL CONDITIONS OF CONTRACT**

The following Special Conditions of Contract shall supplement the General Conditions of Contract. Whenever there is a conflict, the provisions herein shall prevail over those in the Conditions of Contract. The corresponding clause number of the GCC is indicated in parentheses.

### ***Number of GC Clause***

### ***Amendments of, and Supplements to, Clauses in the General Conditions of Contract***

### **Number of GC Clause 1**

#### **Definitions**

**The Procuring Agency is:** Islamabad Electric Supply Company (IESCO) (Material Management Directorate), Chief Engineer (MM) IESCO Headquarters, Street # 40, Sector G-7/4., Islamabad Capital Territory

#### **The Supplier is:**

**The title of the subject procurement is: Procurement of Single Phase AMI Meter with GPRS (2G/4G) Communication Module**

### **Number of GC Clause 3**

#### **Applicable/Governing Law:**

The Contract shall be interpreted in accordance with the laws of Islamic Republic of Pakistan

### **Number of GC Clause 4**

#### **Language:**

The language of the Contract, all correspondence and communications to be given, and all other documentation to be prepared and supplied under the Contract shall be in **English**.

### **Number of GC Clause 5**

#### **Notices:**

#### **The addresses for the notices are:**

Procuring Agency:

Islamabad Electric Supply Company (IESCO) (Material Management Directorate), Chief Engineer (MM)  
IESCO Headquarters, Street # 40, Sector G-7/4., Islamabad Capital Territory  
+92-319-599-1800  
ce\_mm@iesco.com.pk

Contractor/ Bidder:

[Name, address and telephone number].

The Contractor/ Bidder's Representative(s)

[Name, address, telephone number and e-mail address]

**Number of GC Clause 7.1**

**The Authorized Representatives are:**

**For the Procuring Agency:**

Islamabad Electric Supply Company (IESCO) (Material Management Directorate), Chief Engineer (MM)  
IESCO Headquarters, Street # 40, Sector G-7/4., Islamabad Capital Territory  
+92-319-599-1800  
ce\_mm@iesco.com.pk

**For the Bidder:**

**Name:** .....

**Designation:** .....

**Address:** .....

**Number of GC Clause 8**

**Effectiveness of the contract**

**Number of GC Clause 9**

**Commencement of Contract:**

**Number of GC Clause 11.2**

**Expiration of Contract:**

**Number of GC Clause 15**

**Termination**

In the event of termination of the contract due to any reason as already defined in the General Conditions of Contract, the Bidder shall be responsible for providing to the Authority the Goods till the time of alternate arrangements.

**Number of GC Clause 17**

**Conflict of Interest:**

The Procuring Agency reserves the right to determine on a case-by-case basis whether the Bidder should be disqualified from providing goods or services due to a conflict of a nature described in Clause GCC 17.

**Number of GC Clause 22**

**Liquidated Damages**

If the Bidder fails to provide services as required under the contract or in case of any data loss/data breach or any incident compromising the data security or other such failures related to any services, the Bidder shall pay to the Procuring Agency as Liquidated Damages at a rate of **0.06%** to **10.00%** of the Contract value, in accordance with the extent of performance failure & the cost of investigating such incidents as judged by the

Authority.

### **Number of GC Clause 23**

#### **Performance Guarantee:**

The amount of performance guarantee shall be **10.00%** of the contract price in acceptable form of **Call at Deposit, Bank Guarantee**

### **Number of GC Clause 32**

#### **Payment terms:**

Payment will be made to the Bidder against the procured Goods and services according to the actual invoice or running bills submitted by the Bidder against the services provided within the time given in the conditions of the contract.

### **Number of GC Clause 33**

#### **Currency of Payment:**

All the payment to be released to the contractor/Bidder shall be in Pakistani Rupees.

### **Number of GC Clause 34**

#### **Identifying Defects:**

The Authority reserves the right at any time to inspect the premises of the provider to inspect the goods and monitor the goods being provided.

### **Inspections & Tests Requirements**

Conduct pre-shipment testing/Fat ( in case of foreign manufacturer) at the manufacturer's works to be witness by two (02) IESCO Engineers to be nominated by Chief Engineer (MM) IESCO at manufacturer/bidder's expense @ 250 USD dollar per day for foreign inspection and provide test reports as specified in Specification. Bidder will arrange FAT and bear all charges of testing arrangement and other related expenses in case of foreign or local inspection.

In case meter manufactured locally than FAT will be local and if manufactured abroad, FAT will be abroad.

In case of Local manufacturer, Inspection of the material will be carried out at manufacturer's works by Chief Engineer (MI) PPMC Lahore or his authorized representative(s) jointly with rep of IESCO. Notice in writing shall have to be given to Chief Engineer (MI) PPMC Lahore and IESCO (simultaneously) by you when the store against the order is ready for inspection.

All reasonable facilities as provided in the specifications or followed by the Industry or Trade in General shall also have to be afforded to the Inspecting Officer(s) by you at your expenses for carrying out Inspection. You will have to deposit 0.5% of the cost of the material along with the inspection call to the Chief Engineer (MI) PPMC Lahore.

The Inspecting Officer may reject a part or the whole of the consignment tendered for inspection, if he found the material to be below the requirements of the particulars governing the supply given in the purchase order. In such cases:

- i) The decision of the Inspecting Officer shall be binding on you.
- ii) If the material are rejected as aforesaid, then without prejudice to the right of the purchaser you may submit material in replacement of those rejected but re-submission will not mean extension of delivery period. Moreover, the firm/supplier will borne the expenses for the re-inspection of the material that will be offered against the rejected ones.
- iii) On final rejection the purchaser shall have the following rights:-a) To purchase the rejected goods at your cost and expense.b) To terminate the contract and recover from you the loss, the IESCO thereby incurs.

## Delivery & Documents

Delivery period is the essence of the Contract and delivery must be completed not later than the dates specified. 1st day of inspection or 15th day of inspection call whichever is earlier, shall be reckoned as date of delivery of Store to IESCO Consignee provided the goods accepted for supply have been delivered within 20-days for local and 60 days for foreign after issue of Inspection Certificate;

subject to the condition that the supplier/manufacturer offers the material for inspection at least 15-days prior to the due date and the offer is not rejected due to being a fake call or material not conforming to the specification.

Upon delivery of the Goods to the transporter, the Supplier shall notify the Procuring Agency and mail the following documents to the Procuring Agency:

- i) one original plus four copies of the Supplier's invoice showing Goods' description, quantity, unit price, and total amount;
- ii) delivery note, railway receipt, or truck receipt.
- iii) Manufacturer's or Supplier's warranty certificate.
- iv) Inspection certificate issued by PPMC/IESCO.
- v) certificate of country of origin issued by Pakistan Chamber of Commerce and Industry

The above documents shall be received by Consignee before arrival of the Goods and, if not received, the Supplier will be responsible for any consequent expenses.

## Number of GC Clause 37

### Following is the guidance for Dispute Resolution

- i. If any dispute of any kind whatsoever shall arise between the Authority and the Bidder in connection with or arising out of the Contract, including without prejudice to the generality of foregoing, any question regarding its existence, validity, termination and the execution of the Contract – whether during developing phase or after their completion and whether before or after the termination, abandonment or breach of the Contract – the parties shall seek to resolve any such dispute or difference by mutual diligent negotiations in good faith within 14 (fourteen) days following a notice sent by one Party to the other Party in this regard.
- ii. At future of negotiation the dispute shall be resolved through mediation and mediator shall be appointed with the mutual consent of the both parties.

iii. At the event of failure of mediation to resolve the dispute relating to this contract such dispute shall finally be resolved through binding Arbitration by sole arbitrator in accordance with Arbitration Act 1940. The arbitrator shall be appointed by mutual consent of the both parties. The Arbitration shall take place in Islamabad, Pakistan and proceedings will be conducted in English language.

iv. The cost of the mediation and arbitration shall be shared by the parties in equal proportion however the both parties shall bear their own costs and lawyer's fees regarding their own participation in the mediation and arbitration. However, the Arbitrator may make an award of costs upon the conclusion of the arbitration making any party to the dispute liable to pay the costs of another party to the dispute.

v. Arbitration proceedings as mentioned in the above clause regarding resolution of disputes may be commenced prior to, during or after completion of the contract.

Notwithstanding any reference to the arbitration herein, the parties shall continue to perform their respective obligations under the Contract unless they otherwise agree that the Authority shall pay the Bidder any monies due to the Bidder.

**Rules of procedure for arbitration proceedings:**

Any dispute between the Authority and a Bidder who is a national of the Islamic Republic of Pakistan arising in connection with the present Contract shall be referred to adjudication or arbitration in accordance with the laws of the Islamic Republic of Pakistan including Arbitration Act 1940, however above provision shall prevail in referring the case to the Arbitrator.

**Place of Arbitration and Award:**

The arbitration shall be conducted in English language and place of arbitration shall be at Islamabad. The award of the arbitrator shall be final and shall be binding on the parties.



## Bid Securing Declaration

## Form 9: Bid Securing Declaration

Date: *[insert date (as day, month and year)]*

Bid No.: **P54704**

To: **Islamabad Electric Supply Company (IESCO) (Material Management Directorate), Chief Engineer (MM) IESCO Headquarters, Street # 40, Sector G-7/4., Islamabad Capital Territory**

We, the undersigned, declare that:

We understand that, according to your conditions, Bids must be supported by a Bid Securing Declaration.

We accept that we will be blacklisted and henceforth cross debarred for participating in respective category of public procurement proceedings for a period of (not more than) six months, if fail to abide with a bid securing declaration, however without indulging in corrupt and fraudulent practices, if we are in breach of our obligation(s) under the Bid conditions, because we:

1. have withdrawn or modified our Bid during the period of Bid Validity specified in the Form of Bid;
2. Disagreement to arithmetical correction made to the Bid price; or
3. having been notified of the acceptance of our Bid by the Procuring Agency during the period of Bid Validity, (i) failure to sign the contract if required by Procuring Agency to do so or (ii) fail or refuse to furnish the Performance Security or to comply with any other condition precedent to signing the contract specified in the Bidding Documents.

We understand this Bid Securing Declaration shall expire if we are not the successful

Bidder, upon the earlier of (i) our receipt of your notification to us of the name of the successful Bidder; or (ii) twenty-eight (28) days after the expiration of our Bid.



Contract Form

## SECTION IX: CONTRACT FORMS

THIS AGREEMENT made the \_\_\_\_ day of \_\_\_\_\_ 20\_\_\_\_ between **Islamabad Electric Supply Company (IESCO) (Material Management Directorate), Chief Engineer (MM) IESCO Headquarters, Street # 40, Sector G-7/4., Islamabad Capital Territory**

(hereinafter called “the Procuring Agency”) of the one part and [*name of Bidder*] of [*city and country of Bidder*] (hereinafter called “the Bidder”) of the other part:

WHEREAS the Procuring Agency invited Bids for provision of goods, viz., **Procurement of Single Phase AMI Meter with GPRS (2G/4G) Communication Module (P54704)** and has accepted a Bids by the Bidder for the provision of Goods in the sum of [*contract price in words and figures*] (hereinafter called “the Contract Price”).

### NOW THIS CONTRACT WITNESSETH AS FOLLOWS:

1. In this Contract words and expressions shall have the same meanings as are respectively assigned to them in the Conditions of Contract referred to.

2. The following documents shall be deemed to form and be read and construed as part of this Contract, In the event of any ambiguity or conflict between the Contract Documents listed below, the order of precedence shall be the order in which the Contract Documents are listed below:-

1. This form of Contract;
2. the Form of Bids and the Price Schedule submitted by the Bidder;
3. the Schedule of Requirements;
4. the Technical Specifications;
5. the Special Conditions of Contract;
6. the General Conditions of the Contract;
7. the Procuring Agency’s Letter of Acceptance; and
8. [*add here: any other documents*]

3. In consideration of the payments to be made by the Procuring Agency to the Bidder as hereinafter mentioned, the Bidder hereby covenants with the Procuring Agency to provide the Goods related services and to remedy defects therein in conformity in all respects with the provisions of the Contract.

4. The Procuring Agency hereby covenants to pay the Bidder in consideration of the provision of Goods and the remedying of defects therein, the Contract Price or such other sum as may become payable under the

provisions of the contract at the times and in the manner prescribed by the contract.

IN WITNESS whereof the parties hereto have caused this Contract to be executed in accordance with their respective laws the day and year first above written.

Signed, sealed, delivered by \_\_\_\_\_ the \_\_\_\_\_ (for the Procuring Agency)

Witness to the signatures of the Procuring Agency:

.....

Signed, sealed, delivered by \_\_\_\_\_ the \_\_\_\_\_ (for the Procuring Agency)

Witness to the signatures of the Bidder: .....

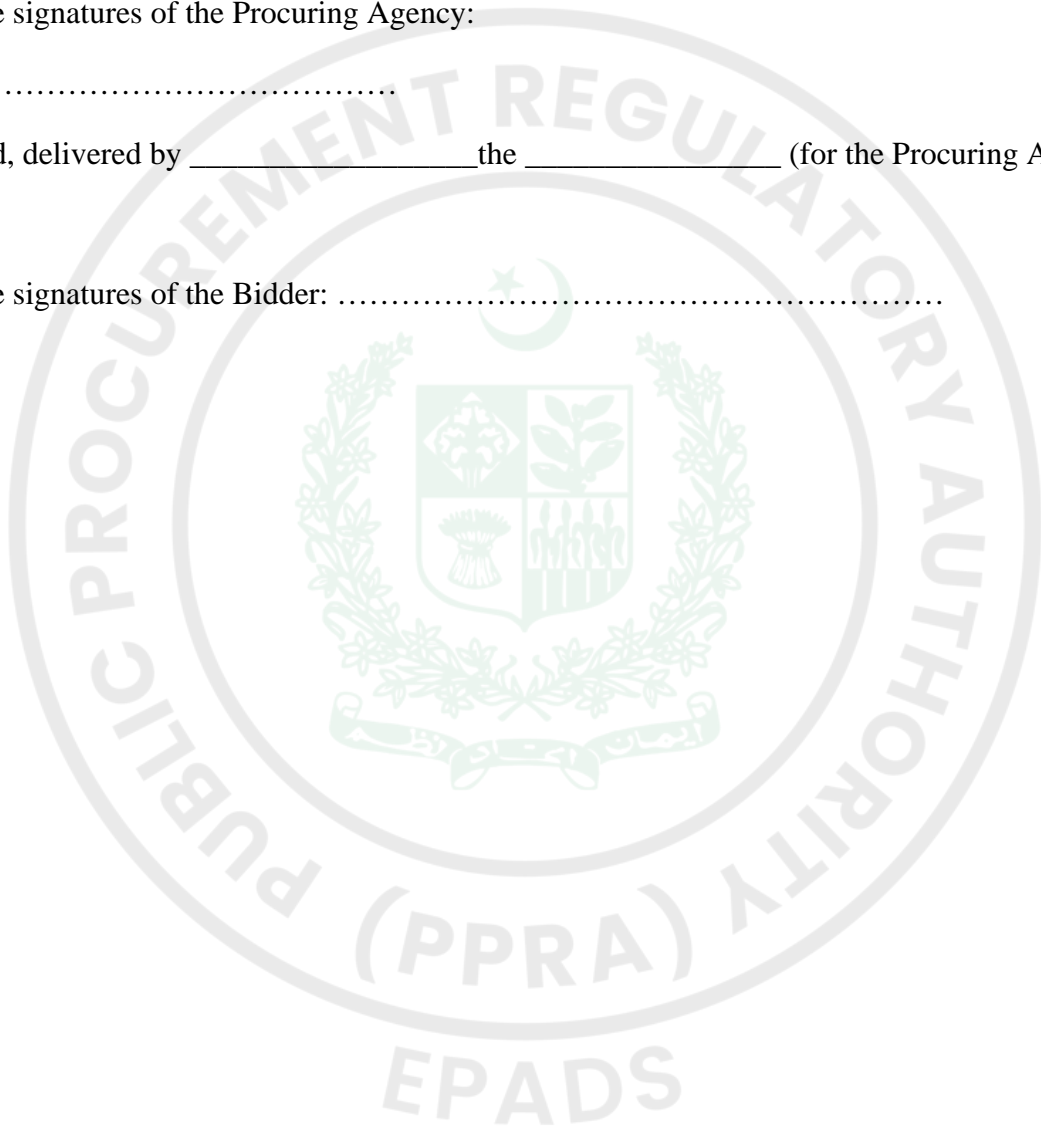



Integrity Pact

## Integrity Pact

### **DECLARATION OF FEES, COMMISSION AND BROKERAGE ETC. PAYABLE BY THE SUPPLIERS OF GOODS, SERVICES & WORKS IN CONTRACTS WORTH RS.10.00 MILLION OR MORE**

**Contract**

Number: Contract

Value: Contract Title:

Dated:

[Name of Supplier] hereby declares that it has not obtained or induced the procurement of any contract, right, interest, privilege or other obligation or benefit from Government of Pakistan or any administrative subdivision or agency thereof or any other entity owned or controlled by it (GoP) through any corrupt business practice.

Without limiting the generality of the foregoing [Name of Supplier] represents and warrants that it has fully declared the brokerage, commission, fee etc. paid or payable to anyone and not given or agreed to give and shall not give or agree to give to anyone within or outside Pakistan either directly or indirectly through any natural or juridical person, including its affiliate, agent, associate, broker, consultant, director, promoter, shareholder, sponsor or subsidiary, any commission, gratification, bribe, finder's fee or kickback, whether described as consultations fee or otherwise, with the object of obtaining or inducing the procurement of a contract, right, interest, privilege or other obligation or benefit in whatsoever form from GoP, except that which has been expressly declared pursuant hereto.

[Name of Supplier] certifies that it has made and will make full disclosure of all agreements and arrangements with all persons in respect of or related to the transaction with GoP and has not taken any action or will not take any action to circumvent the above declaration, representative or warranty.

[Name of Supplier] accepts full responsibility and strict liability for making and false declaration, not making full disclosure, misrepresenting fact or taking any action likely to defeat the purpose of this declaration, representation and warranty. It agrees that any contract, right interest, privilege or other obligation or benefit obtained or procured as aforesaid shall, without prejudice to any other right and remedies available to GoP under any law, contract or other instrument, be voidable at the option of GoP.

Notwithstanding any rights and remedies exercised by GoP in this regard, [Name of Supplier] agrees to indemnify GoP for any loss or damage incurred by it on account of its corrupt business practices and further pay compensation to GoP in an amount equivalent to ten times the sum of any commission, gratification, bribe, finder's fee or kickback given by [Name of Supplier] as aforesaid for the purpose of obtaining or inducing the procurement of any contract, right, interest, privilege or other obligation or benefit in whatsoever form from GoP.



## Performance Guarantee Form

## Performance Guarantee Form

To: **Islamabad Electric Supply Company (IESCO) (Material Management Directorate), Chief Engineer (MM) IESCO Headquarters, Street # 40, Sector G-7/4., Islamabad Capital Territory**

WHEREAS *[name of Bidder]* (hereinafter called “the Bidder”) has undertaken, in pursuance of Contract No. *[reference number of the contract]* dated *[insert date]* for provision of Goods(hereinafter called “the Contract”).

AND WHEREAS it has been stipulated by you in the said Contract that the Bidder shall furnish you with a Bank Guarantee by a reputable bank for the sum specified therein as security for compliance with the Bidder’s performance obligations in accordance with the Contract.

AND WHEREAS we have agreed to give the Bidders guarantee:

THEREFORE, WE hereby affirm that we are Guarantors and responsible to you, on behalf of the Bidder, up to a total of *[amount of the guarantee in words and figures]*, and we undertake to pay you, upon your first written demand declaring the Bidder to be in default under the Contract and without cavil or argument, any sum or sums within the limits of *[amount of guarantee]* as aforesaid, without your needing to prove or to show grounds or reasons for your demand or the sum specified therein.

This guarantee is valid until the: *[insert date]*

Signature and seal of the Guarantors

---

*[name of bank or financial institution]*

---

[address]

---

[date]





Annexure

## Bid Data Sheet

For Compliance.

Technical Submission (Vendor)

Document Required

See Form Under Additional Forms and Documents: **Bid Data Sheet** (page number: 72)

## Price Schedule Form

Financial Submission (Vendor)

Document Required

See Form Under Additional Forms and Documents: **Price Schedule Form** (page number: 74)

## Production Capacity Form

Technical Submission (Vendor)

Document Required

See Form Under Additional Forms and Documents: **Production Capacity Form** (page number: 76)

## IESCO AMI Specification

For Compliance.

Technical Submission (Vendor)

Document Required

See Form Under Additional Forms and Documents: **IESCO AMI Specification** (page number: 77)

## Declaration of Beneficial Owner

Technical Submission (Vendor)

Document Required

See Form Under Additional Forms and Documents: **Declaration of Beneficial Owner** (page number: 337)

## Bid Security Form

Technical Submission (Vendor)

Document Required

See Form Under Additional Forms and Documents: **Bid Security Form** (page number: 339)

## Power of Attorney

Technical Submission (Vendor)

Document Required

See Form Under Additional Forms and Documents: **Power of Attorney** (page number: 340)

## Bidder Information form

Technical Submission (Vendor)

Document Required

See Form Under Additional Forms and Documents: **Bidder Information form** (page number: 341)

## Bidder JV Member information form

Technical Submission (Vendor)

Document Required

See Form Under Additional Forms and Documents: **Bidder JV Member information form** (page number: 342)

## Financial Resources Form

Technical Submission (Vendor)

Document Required

See Form Under Additional Forms and Documents: **Financial Resources Form** (page number: 343)

## Financial Situation Form

Technical Submission (Vendor)

Document Required

See Form Under Additional Forms and Documents: **Financial Situation Form** (page number: 344)

## Annual Average Turnover Form

Technical Submission (Vendor)

Document Required

See Form Under Additional Forms and Documents: **Annual Average Turnover Form** (page number: 345)

## Manufacturer Authorization Form

Technical Submission (Vendor)

Document Required

See Form Under Additional Forms and Documents: **Manufacturer Authorization Form** (page number: 346)

## Deviations from Technical Provisions

Technical Submission (Vendor)

Document Required

See Form Under Additional Forms and Documents: **Deviations from Technical Provisions** (page number: 347)

## Deviations from Contractual Condition

Technical Submission (Vendor)

Document Required

See Form Under Additional Forms and Documents: **Deviations from Contractual Condition** (page number: 348)

## Eligible Countries

Technical Submission (Vendor)

## Document Required

See Form Under Additional Forms and Documents: **Eligible Countries** (page number: 349)

## Schedule of Requirements

For Compliance.

Technical Submission (Vendor)

## Document Required

See Form Under Additional Forms and Documents: **Schedule of Requirements** (page number: 350)

## Special Conditions of Contract

For Compliance

Technical Submission (Vendor)

## Document Required

See Form Under Additional Forms and Documents: **Special Conditions of Contract** (page number: 369)

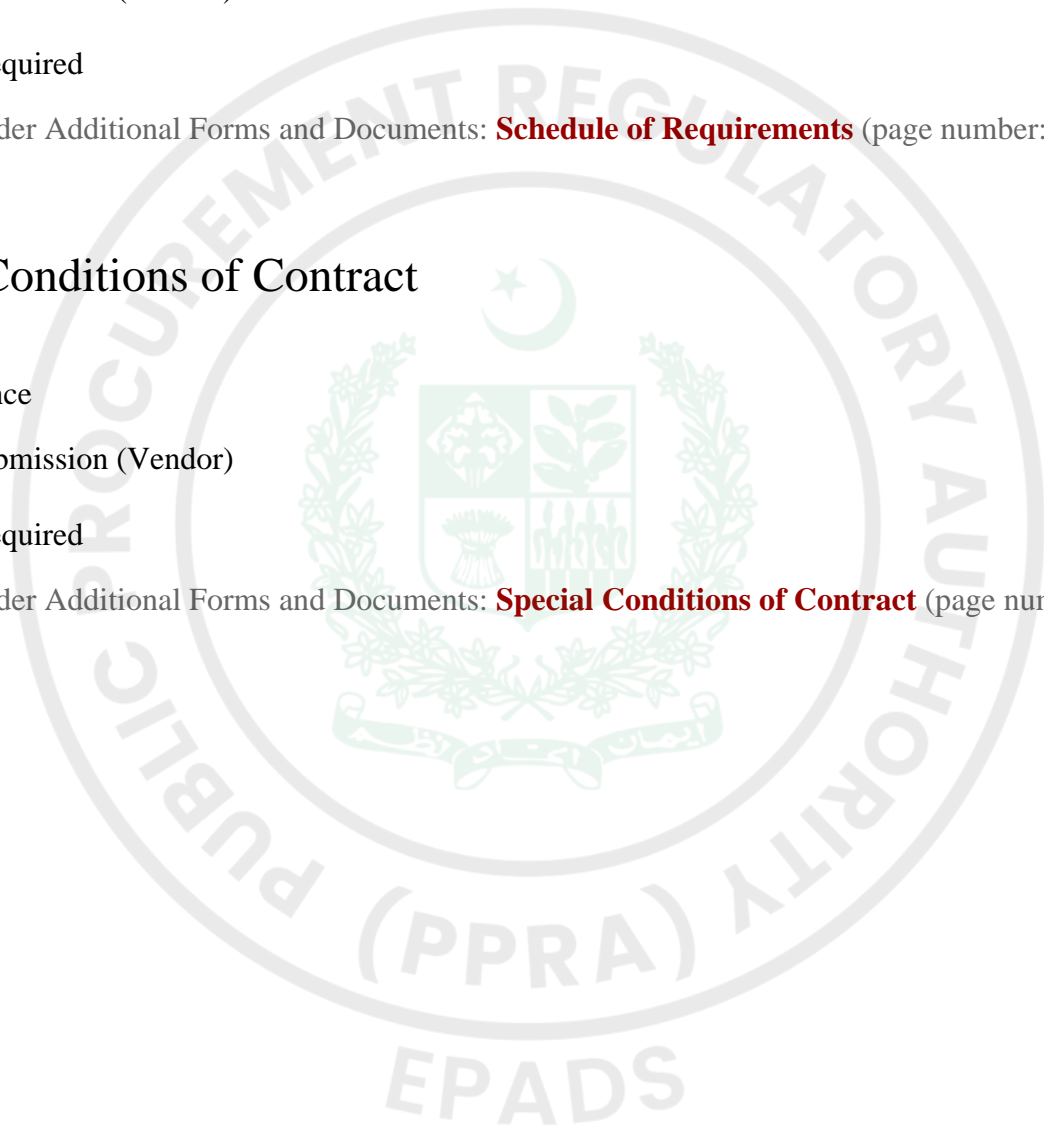



## Procurement Forms

## Past Experience and Completed Contracts

See Form Under Additional Forms and Documents: **Past Experience and Completed Contracts** (page number: 373)

## Historical Contract Non-Performance, and Pending Litigation and Litigation History

See Form Under Additional Forms and Documents: **Historical Contract Non-Performance, and Pending Litigation and Litigation History** (page number: 374)

## Current Contracts and Their Progress

See Form Under Additional Forms and Documents: **Current Contracts and Their Progress** (page number: 376)

## Financial Capacity and Net Worth Evaluation Form

Attach confirm and valid Bank Credit line (latest) (if any) required to establish cash flow or financial resources

See Form Under Additional Forms and Documents: **Financial Capacity and Net Worth Evaluation Form** (page number: 377)





## Additional Forms and Documents

## Bid Data Sheet (BDS)

The following specific data for the goods to be procured shall complement, supplement, or amend the provisions in the Instructions to Bidders (ITBs). Whenever there is a conflict, the provisions herein shall prevail over those in ITBs.

BDS Clause Number	ITB Number	Amendments of, and Supplements to, Clauses in the Instruction to Bidders
<b>Award of Contract</b>		
1.	37.1	<p><i>(i) IESCO reserves the right to increase/decrease the tender quantity upto 15% at the time of issuance of LOI/purchase order.</i></p> <p style="text-align: center; color: red;"><b>OR</b></p> <p><i>(ii) The IESCO reserves the right to increase or decrease the quantity of the supply during the currency of contract up to 15%. Currency of contract will be upto six months from the issue of P.O. or the actual delivery period whichever is more.</i></p>
<b>Evaluation Criteria</b>		
2.	29	<ul style="list-style-type: none"> <li>i. Bid conforms to tender conditions and laid down specifications.</li> <li>ii. Responsiveness in terms of technical and commercial evaluation.</li> <li>iii. Previous performance/appraisal of the bidder <b>or supply record of the product</b> supplied by them.</li> <li>iv. Copy of P.Os of the similar nature product i.e. AMI or others conventional meters previously supplied by the bidder/manufacturer.</li> <li>v. Production Capability/Capacity, to meet the tender requirement as per attached annexure.</li> <li>vi. Manufacturing experience of at least 2-years or more for similar products i.e. AMI /conventional meters.</li> <li>vii. Contractual / Supply experience of similar nature material i.e. AMI or others conventional meters for at least one year or more.</li> <li>viii. The bidder's net worth during last three (03) years calculated as the difference between total assets and total liabilities should be positive. In case of JV, each partner must meet this requirement.</li> <li>ix. The bidder should have an Average annual turnover AATO in the last 3-years equal to one &amp; half (1.5) times of the contract value. In case of JV, lead partner must meet 60% of the required AATO requirement and other partners must meet 40% of the requirement.</li> <li>x. The net financial resources as per Form FIN-3 should be at least 50% of the contract value (after subtracting the current commitments/liabilities). In case of JV, lead partner must meet 60% of the required financial resources requirement and other partners must meet 40% of the requirement.</li> <li>xi. All pending litigation, arbitration or other material events impacting the net worth and/or liability of the bidder, is any, shall be treated as resolved against the bidder and so shall in total not represent more than 50% of the bidder's net worth. In case of JV, each partner must meet this requirement.</li> <li>xii. If a new firm emerged as a lowest bidder and having no experience of manufacturing AMI / conventional meters, will be awarded with educational/trial order.</li> <li>xiii. Possession of valid prototype approval at the time of submission of bid. Prototype approval or type test report will be attached at time of bid submission. In case, bidder fails to provide valid prototype approval, then bidder will provide undertaking to carry out fresh prototype testing without effecting the delivery period on bidder cost and arrangement duly witness by (02) IESCO engineers. The type test can be conducted at the place of manufacturer's lab, and other lab (if required) as per IESCO standards. The requisite process of type test already</li> </ul>

**Stamp & Signature of Bidder**

		<p>described in bidding document. If meter is manufactured local, type test can be carried out locally from any IEC/IEEE registered lab. In other case, if meter is manufactured abroad, type test will be carried out abroad.</p> <p>The cost of boarding, lodging and TA/DA for witnessing personnel will be borne by bidder in case type test is offered locally from labs (IEC/IEEE registered) recommended in bid document. The bidder can estimate this cost depending on location of lab, period of testing etc.</p> <p>In case, type test is going to be performed from foreign accredited lab, only final test report will be shared for evaluation.</p> <p>xiv. If a bidder participates as manufacturer, then in case of award of contract, fresh prototype/type testing shall be carried out exclusively on the name of bidder/manufacturer as per IESCO AMI Meter Specifications without affecting delivery schedule.</p> <p><b><i>In case bidder/manufacturer fails to fulfill the criteria, its bid will be considered non-responsive.</i></b></p> <p>The most advantageous bid, which may be complying with above evaluation criteria, will be considered based on least cost method.</p>
--	--	---



**Stamp & Signature of Bidder**

## Price Schedule Forms

Name of Bidder: \_\_\_\_\_

Tender No. & date of opening	Description of Material	Tender Qty (No.)	Rate in Rs. Per unit on FCS basis excluding GST and without involving any foreign exchange.	Total Amount w/o GST [(c)x(d)]	18% GST (full quantity) [(18%) x (e)]	Total Amount with GST [(e)+(f)]	Delivery Schedule From the date of issuance of P.O
(a)	(b)	(c)	(d)	(e)	(f)	(g)	(h)
16 22.07.26	Single Phase AMI Meter with GPRS (2G/4G) Communication Module	Lot-I	58333				"19445 No. within 45 days, 19444 No. within 75 days & balance 19444 No. quantity within 105 days from the date of issuance of P.O, where bidder (local / foreign) has valid prototype approval and interoperability certificate of offered type meter" "Otherwise 50% quantity within 120 days & balance 50% quantity within 150 days from the date of issuance of P.O inclusive of interoperability and prototype testing"
		Lot-II	58333				"19445 No. within 45 days, 19444 No. within 75 days & balance 19444 No. quantity within 105 days from the date of issuance of P.O, where bidder (local / foreign) has valid prototype approval and interoperability certificate of offered type meter" "Otherwise 50% quantity within 120 days & balance 50% quantity within 150 days from the date of issuance of P.O inclusive of interoperability and prototype testing"

**Stamp & Signature of Bidder**

		Lot-III	58334					<i>"19445 No. within 45 days, 19445 No. within 75 days &amp; balance 19444 No. quantity within 105 days from the date of issuance of P.O, where bidder (local / foreign) has valid prototype approval and interoperability certificate of offered type meter"</i> <i>"Otherwise 50% quantity within 120 days &amp; balance 50% quantity within 150 days from the date of issuance of P.O inclusive of interoperability and prototype testing"</i>
--	--	---------	-------	--	--	--	--	--

**Note: The Prices quoted by the bidder on the E-PADS in price schedule section shall be deemed inclusive of all applicable taxes, duties, and other statutory charges.**

Amount of Bid Bond: \_\_\_\_\_.

Bid Security validity: \_\_\_\_\_.

Model/Make of Equipment: \_\_\_\_\_.

Issuing Authority: \_\_\_\_\_.

**Note:** In case of discrepancy between unit price and total, the Unit Price shall prevail.

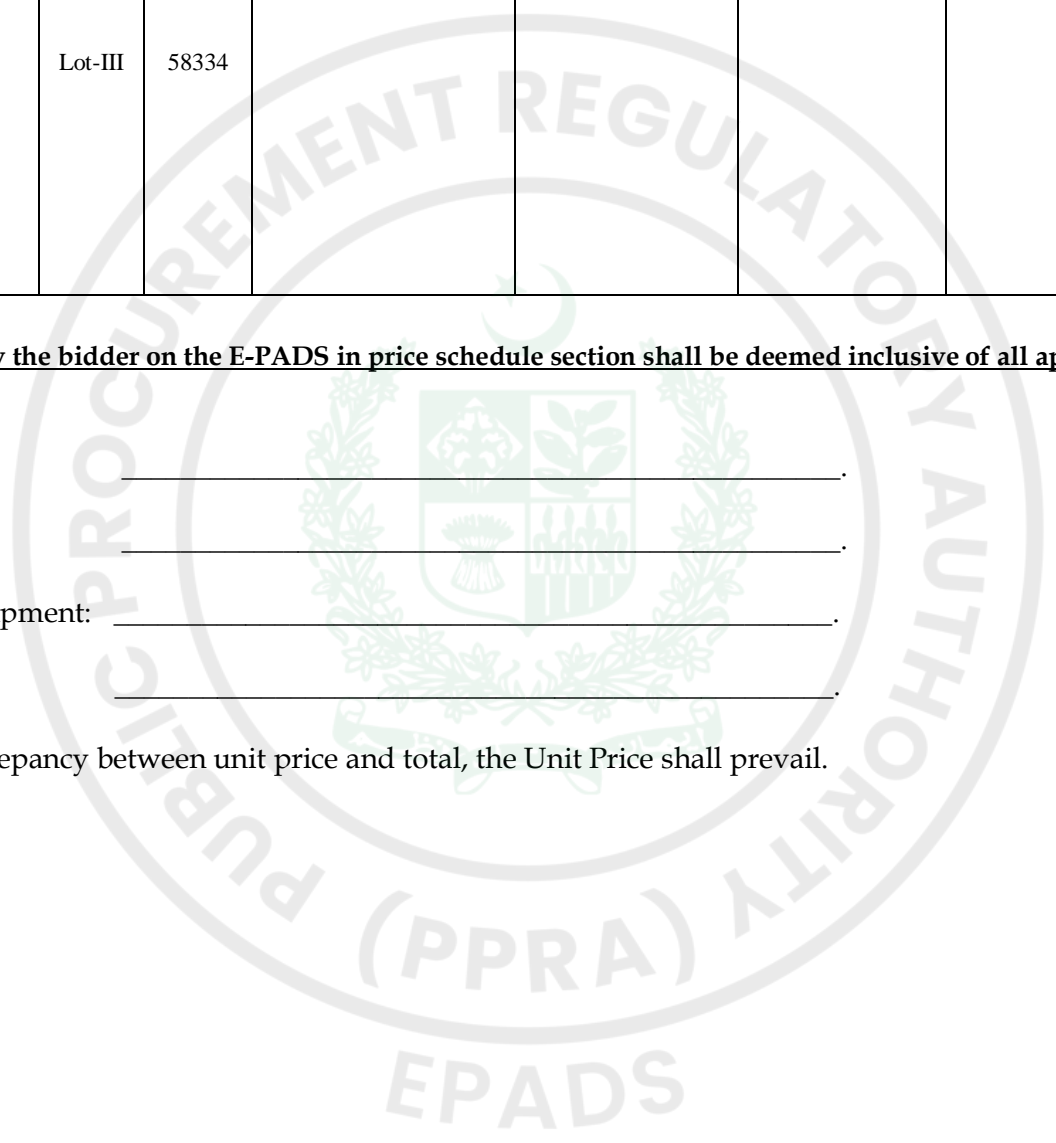

**Stamp & Signature of Bidder**

### Production Capacity of Manufacturer

Sr #	Description	Factory Capacity in unit as mentioned in Price schedule
A	Total Factory Production Capacity ( No. or Sets or other unit)/Year	
B	Order in Hand ( No. or Sets or other unit)	
C	Expected order during execution of this contract if awarded(No. or Sets or other unit)	
D	Quantity of this order	
E	Remaining Capacity of Factory ( No. or Sets or other unit) E= (A-B-C-D)	
<b>A ≥ 2xE</b>		



# TSW-AMI-02

Single Phase -2 Wire Whole Current AMI Energy Meter

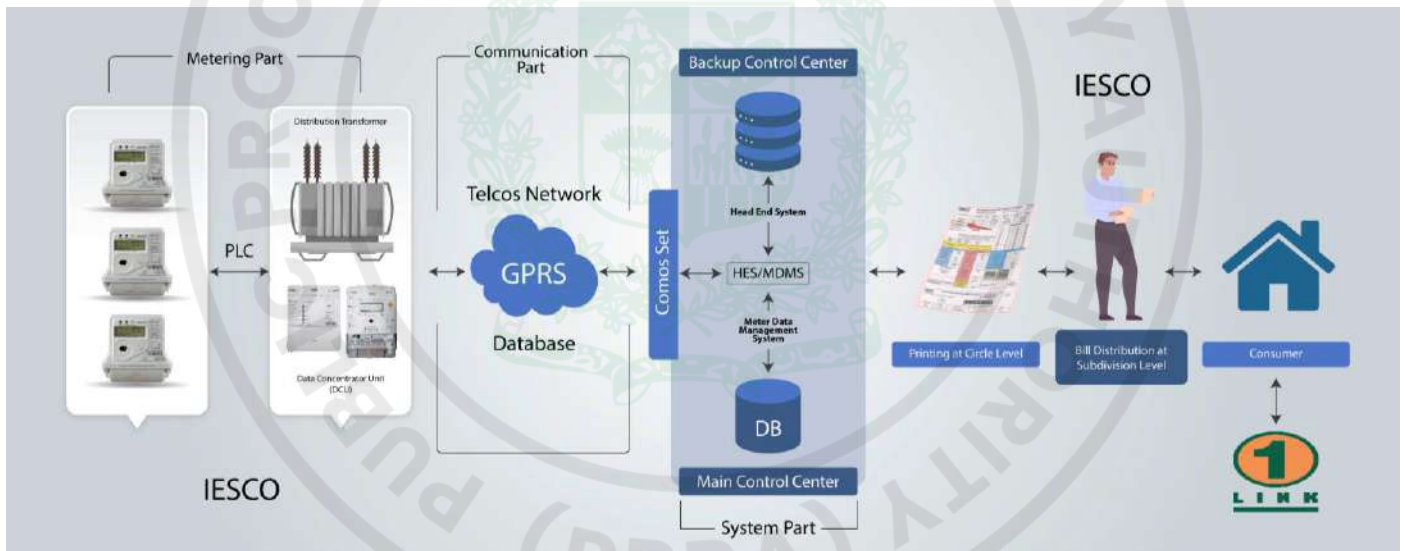



## Content

<b>1</b>	<b>FORWARD</b> .....	<b>07</b>
<b>2</b>	<b>SCOPE</b> .....	<b>07</b>
<b>3</b>	<b>REFERNCE STANDARD</b> .....	<b>07</b>
<b>4</b>	<b>DEFINATION</b> .....	<b>08</b>
<b>5</b>	<b>SERVICE CONDITION</b> .....	<b>10</b>
<b>6</b>	<b>ELECTRICAL CONSTRUCTION REQUIREMENT</b> .....	<b>11</b>
6.1	Technical Parameters of Energy meters .....	11
6.2	Accuracy Features .....	13
6.2.1	Limits of error due to variation of the current	
6.2.2	Limits of error due to influence quantities	
<b>7</b>	<b>MECHANICAL CONSTRUCTION REQUIREMENT</b> .....	<b>16</b>
7.1	General Mechanical Requirement	
7.2	Electrical Connection	
7.3	Energy Meter case	
7.4	Meter Cover	
7.5	Terminals and Terminal Block	
7.6	Terminal Cover	
7.7	Mounting Block	
7.8	Energy meter Security Box	
7.9	Poly Carbonate material	
7.10	Display Button	
7.11	External Battery Slot	
7.12	Earthing Connection Arrangement	
7.13	Protection against solar radiation, penetration of Dust and water , Glow wire	
7.14	Sealing of energy meter	
7.15	Meter Serial Number	
<b>8</b>	<b>ENERGY METER FUNCTIONAL CHARACTERISTIC</b> .....	<b>18</b>
8.1	Measurement	
8.2	Real time Clock	
8.3	Backup supply	
8.4	Tariff	
8.5	Billing	
8.6	Display and Indicators	
8.7	Payment mode	
8.8	Load profile	
8.9	Relay Control	
8.10	Power Limitation	
8.11	Over Current	
8.12	Demand Side Management	
8.13	Export Energy Function	
8.14	Load monitoring Function	
8.15	Anti Tamper	
8.16	DC Immunity	
8.17	Self-diagnostics and Meter Status Word	
8.18	Firmware Upgrade	
8.19	Event Log	

<b>9</b>	<b>COMMUNICATION INTERFACES</b> .....	<b>40</b>
9.1	Optical Port Communication	
9.2	Remote Communication	
9.3	4G/2G Communication	
9.4	G-3 PLC Communication	
<b>10</b>	<b>SECURITY</b> .....	<b>48</b>
10.1	PHYSICAL SECURITY	
10.2	COMMUNICATION SECURITY	
10.3	KEYS	
<b>11</b>	<b>TESTING</b> .....	<b>49</b>
11.1	Physical Security	
11.2	Sample testing ,Acceptance and Rejection	
11.3	Type Test	
11.4	Pre Shipment Inspection	
<b>12</b>	<b>NAME &amp; RATING PLATE</b> .....	<b>55</b>
<b>13</b>	<b>SAMPLE FOR INTEROPERABILITY</b> .....	<b>55</b>
<b>14</b>	<b>PACKING</b> .....	<b>55</b>
<b>15</b>	<b>WARRANTY</b> .....	<b>55</b>
<b>16</b>	<b>ANNEXURE</b>	
	<b>ANNEX 1 REFERENCE STANDARDS</b> .....	<b>57</b>
	<b>ANNEX 2 DEFAULT TARIFF SCHEME</b> .....	<b>61</b>
	<b>ANNEX 3 DISPLAY ITEM LIST</b> .....	<b>62</b>
	<b>ANNEX 4 Smart Meter Companion Specification</b>	
	<b>ANNEX 5 Communication Module Specification</b>	

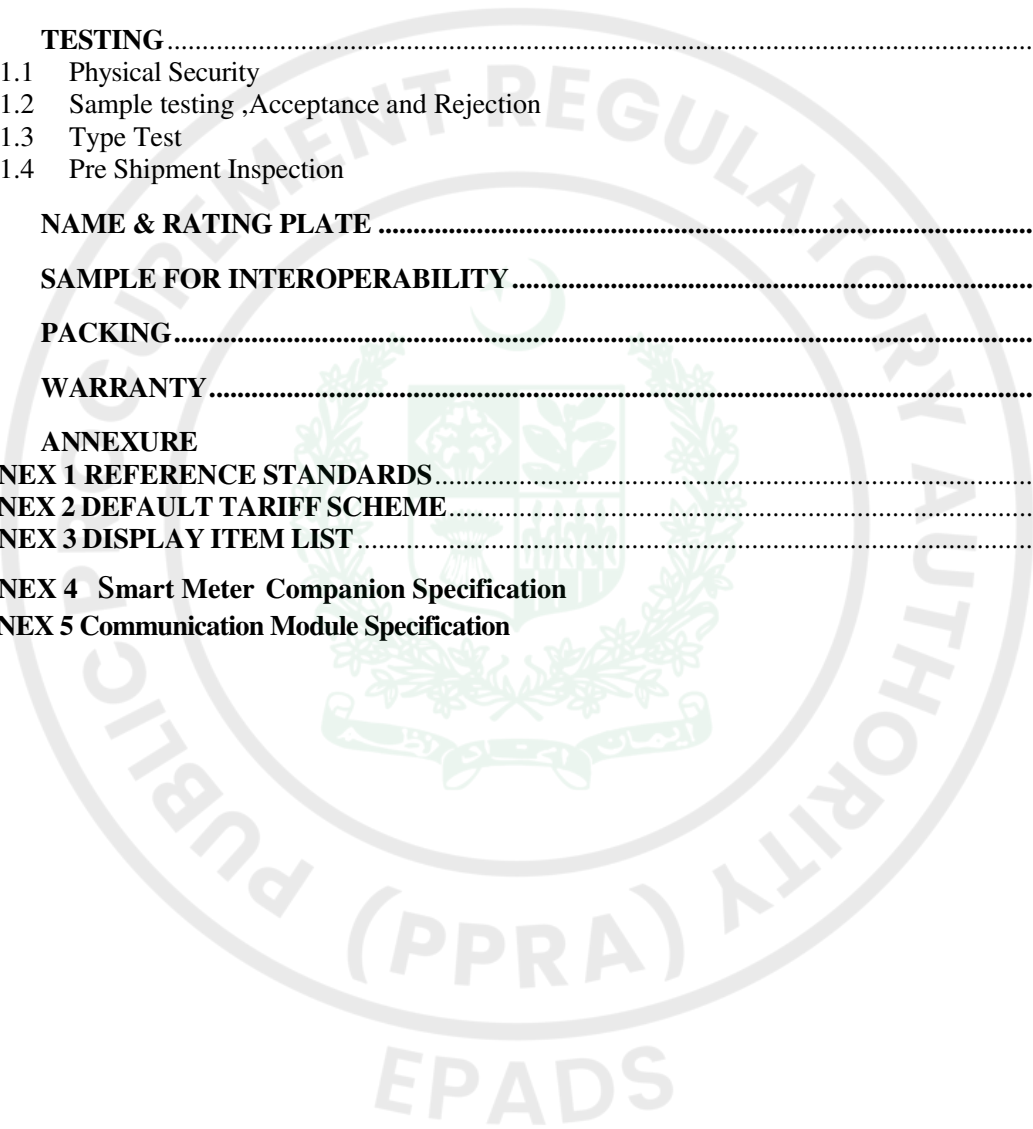

## Abbreviation

+A	Active energy import
-A	Active energy export
+R	Reactive energy import
-R	Reactive energy export
R1	Reactive energy for quadrant 1
R2	Reactive energy for quadrant 2
R3	Reactive energy for quadrant 3
R4	Reactive energy for quadrant 4
P	Active power
+P	Active power import
-P	Active power export
Q	Reactive power
+Q	Reactive power import
-Q	Reactive power export
MD	Maximum Demand
PF	Power Factor
TOU	Time Of Use
RTC	Real Time Clock
<b>PLC</b>	Power Line Communication
RBAC	Role-Based Access Control
DLMS	Device Language Message Specification
COSEM	Companion Specification for Energy Metering
HLS	High Level Security
ESD	Electrostatic Discharge
LCD	Liquid Crystal Display
LED	Light-Emitting Diode
SIM	Subscriber Identity Module
RSSI	Received Signal Strength
RSRP	Reference Signal Received Power
RSRQ	Reference Signal Received Quality
APN	Access Point Name
PDP	Program Decision Package
DHCP	Dynamic Host Configuration Protocol
IMEI	International Mobile Equipment Identity
PAP	Password Authentication Protocol
CHAP	Challenge Handshake Authentication Protocol
IMSI	International Mobile Subscriber Identity
FDD	Frequency Division Duplexing
CAT	LTEUE-Category
RADIUS	Remote Authentication Dial In User Service
MAC	Media Access Control
FCC	Federal Communications Commission
DBPSK	Differentially coherent Binary Phase Shift Keying
DQPSK	Differential Quadrature Phase Shift Keying
D8PSK	Eight-Ary Differential Phase-Shift Keying
AES	Advanced Encryption Standard
GCM	Galois/Counter Mode

HLV	Hazardous live voltage
SELV	Safety extra low voltage
ICMP	Internet Control Message Protocol
PAN	Personal Area Networks
RS	Router Solicitation
RA	Router Advertisement
4G	The 4 <sup>th</sup> generation mobile communication technology
2G	2-Generation wireless telephone technology
UART	Universal Asynchronous Receiver/Transmitter
TRP	Total Radiated Power
TIS	Total Isotropic Sensitivity
SWR	Voltage Standing Wave Ratio

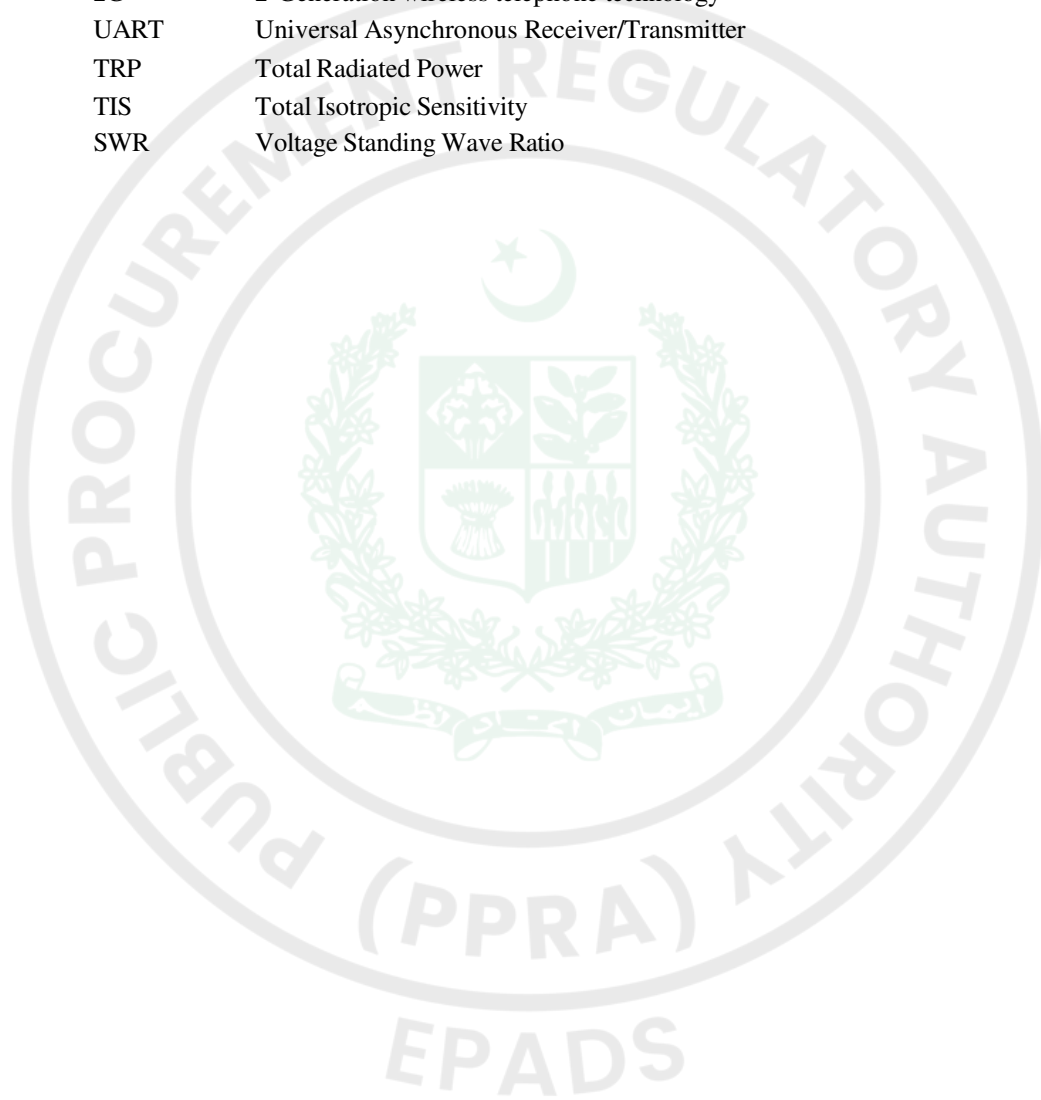

## 1. FOREWORD

- 1.1 The TSW Department of IESCO has prepared this Specification.
- 1.2 This Specification is intended for the purpose of technical specification only for the procurement of material and does not include provisions of contract, unless otherwise provided in the contract.
- 1.3 This Specification is subject to revision as and when required.

## 2. SCOPE

- 2.1 This specification pertaining to Single Phase Multi Rate Tariff ,Single Element ,2-Wire ,230 volts, 5(40) Amp, 50 Hz Whole Current Energy meter ,KWh Accuracy Class 1 and KVARh accuracy class 2, Bi-Directional AMI Energy Meter and covers the design, engineering, manufacture, assembly, inspection, testing at manufacturer's premise before dispatch.
- 2.2 The complete Build unit (CBU) ie meter, internal CTs and Communication Module 4G/2G or PLC (As per tender Inquiry) shall be housed in the same enclosure. The meter shall have provision in such a way that supply / service cable of consumer shall be directly passed through the meter for current measurement. Piercing screws shall be used in the meter for voltage connection.
- 2.3 The meter shall be capable to measuring, record and display the following Features

A	Active Energy Export(KWH)
B	Reactive Energy Export(KVARH)
C	Active Energy import(KWH)
D	Reactive Energy import(KVARH)
E	Maximum Demand of Active Energy Export(KW)
F	Maximum Demand of Reactive Energy Export (KVAR)
G	Maximum Demand of Active Energy import(KW)
H	Maximum Demand of Reactive Energy import(KVAR)

- 2.4 It supports multi-tariff, monthly billing, daily billing, energy load profile, power quality load profile, event detection, neutral current detection, supply control and prepayment function etc. A modular-designed communication 4G/2G module, or PLC module (As per tender Inquiry) <sup>1</sup> which supports plug and play without power off the meter. Some functions are kept disabled by default, e.g. export energy segments but are configurable and can be activated later on demand of purchaser.

*1. Purchaser will mention the type of communication module in bidding document.*

- 2.5 The material shall conform in all respects to high standards of engineering, design and workmanship and shall be capable of performing in continuous commercial operation in a manner acceptable to the purchaser.
- 2.6 Purchaser will interpret the meanings of drawings and specification and shall have the right to reject any work or material which in his judgment is not in accordance therewith. The offered materials shall be complete with all components, accessories necessary for their effective and trouble free operation in the system for energy measurement

## 3. REFERENCE STANDARDS

- 3.1 The Reference standards to be used for manufacturing of Energy meters and testing are listed and provided in Annex – I.
- 3.2 In case of parameter or any other condition of this specification, deviates from International standard, then provision of this specification shall prevail.

**4. DEFINITIONS**

Sr.	Terms	Definition
1	<b>Static Watt-Hour Meter</b>	Meter in which current and voltage act on solid-state (electronic) element to produce an output proportional to watt-hour.
2	<b>Multi-Rate Meter</b>	Energy meter provided with a number of registers, each becoming operative at specified time intervals corresponding to different tariffs
3	<b>Measuring Element</b>	Part of the meter which produces an output proportional to the energy.
4	<b>Test Output</b>	Device which can be used for testing the meter
5	<b>Operational Indicator</b>	Device, which gives a visible signal of the operation of the meter.
6	<b>Memory</b>	Element which stores digital information
7	<b>Non-volatile memory</b>	Storage device which can retain information in the absence of power
8	<b>Display</b>	Device which displays the content(s) of memory (ies)
9	<b>Register</b>	Electronic device comprising both memory and display, which stores and displays information.
10	<b>Current circuit</b>	Internal connections of the meter and part of the measuring element through which flows the current of the circuit to which the meter is connected.
11	<b>Voltage circuit</b>	Internal connections of the meter, part of the measuring element and power supply for the meter supplied with the voltage of the circuit to which the meter is connected
12	<b>Auxiliary circuit</b>	Elements (lamps, contacts, etc.) and connection of an auxiliary device within the meter case intended to be connected to an external device for example clock, relay, and impulse counter.
13	<b>Constant</b>	Value expressing the relation between the energy registered by the meter and the corresponding value of the test output. If this value is a number of pulses, the constant should be either pulses per kilowatt-hour (imp/kWh) or watt-hours per pulse (Wh/imp).
14	<b>Indoor meter</b>	Meter which can only be used with additional protection against environmental influences (in a house, in a cabinet)
15	<b>Outdoor meter</b>	Meter which can be used without additional protection in an exposed environment
16	<b>Base</b>	Back of the meter by which it is generally fixed and to which are attached the measuring element, the terminals or the terminal block, and the cover.
17	<b>Cover</b>	Enclosure on the front of the meter, made either wholly of transparent material or opaque material provided with window (s) through which the operational indicator (if fitted) and the display can be read.
18	<b>Case</b>	Comprises the base and the cover

Sr.	Terms	Definition
19	<b>Protective earth terminals</b>	Terminal connected to accessible conductive parts of the meter for safety purposes
20	<b>Terminal block</b>	Support made of insulating material on which all or some of the terminals of the meter are grouped together.
21	<b>Terminal cover</b>	Cover, which covers the meter terminals and generally, the ends of the external wires or cables, connected to the terminals.
22	<b>Clearance</b>	Shortest distance measured in air between two conductive parts.
23	<b>Creepage distance</b>	Shortest distance measured over the surface of insulation between two conductive parts.
24	<b>Basic insulation</b>	Insulation applied to live parts to provide basic protection against electric shock.
25	<b>Basic current (in)</b>	Value of current in accordance with which the relevant performance of the meter is fixed.
26	<b>Maximum current (Imax)</b>	Highest value of current at which the meter purports to meet the accuracy requirements of this standard.
27	<b>Reference voltage</b>	Value of the voltage in accordance with which the relevant performance of the meter is fixed.
28	<b>Reference frequency</b>	Value of the frequency in accordance with which the relevant performance of the meter is fixed.
29	<b>Percentage error</b>	<p>Percentage error is given by the following formulas:-</p> $\text{Percentage error} = \frac{\text{Energy registered by the meter} - \text{True energy}}{\text{True energy}} \times 100$ <p>Since the true value cannot be determined, it's approximated by a value with a stated uncertainty that can be traced to standards agreed upon between manufacturer and user or to national standards.</p>
30	<b>Reference conditions</b>	Appropriate set of influence quantities and performance characteristics, with reference values, their tolerance and reference ranges, with respect to which the intrinsic error is specified.
31	<b>Electromagnetic disturbance</b>	Conducted or radiated electromagnetic interference, which may affect functionality or metrological operation of the meter.
32	<b>Rated operating conditions</b>	Set of specified measuring ranges for performance characteristics and specified operating ranges for influence quantities, within which the variations or operating errors of a meter are specified and determined.
33	<b>Specified measuring range</b>	Set of values of a measured quantity for which the error of a meter is intended to lie within specified limits.
34	<b>Specified operating range</b>	Range of values of a Single influence quantity, which forms a part of the rated operating conditions

Sr.	Terms	Definition
35	<b>Limit range of operation</b>	Extreme conditions, which an operating meter can withstand without damage and without degradation of its metrological characteristics when it is subsequently operated under its rated operating conditions
36	<b>Storage and transport conditions</b>	Extreme conditions, which a non-operating meter can withstand without damage and without degradation of its metrological characteristics when it is subsequently operated under its rated operating conditions
37	<b>Normal working position</b>	Position of the meter defined by the manufacturer for normal services.
38	<b>Thermal stability</b>	Thermal stability is considered to be reached when the change in error as a consequence of thermal effects is, during 20 min., less than 0.1 times the maximum permissible error for the measurement under consideration.
39	<b>Advance Metering infrastructure</b>	Advance Metering infrastructure (AMI) are systems that measure, collect and analyze energy usage and communicate with metering devices such as electricity meter, either on request or on schedule. These systems include hardware, software, communications, HES and meter data management (MDM) software etc.
40	<b>MDM</b>	Meter data management server is a system in advance metering infrastructure used to obtain data from the meters and store in the database.
41	<b>HES</b>	Head-End System is hardware and software that receives the stream of meter data brought back to the utility through the AMI
42	<b>Pull</b>	Pull is a mechanism in which MDM demands for specific information or data from meter and meter send data in response.

## 5. SERVICE CONDITIONS

5.1 The meter to be supplied against this specification shall be suitable for continuous operation under the following tropical conditions:

### Climatic Condition

- |     |                                       |   |                            |
|-----|---------------------------------------|---|----------------------------|
| a). | Peak ambient temperature              | - | 55°C                       |
| b). | Mean max. temperature during 24 hours | - | 45°C                       |
| c). | Minimum temperature                   | - | -10°C                      |
| d). | Maximum relative humidity             | - | 100%                       |
| e). | Average annual rain fall              | - | 150 mm                     |
| f). | Maximum Altitude                      | - | 1000 meter above Sea Level |
| g). | Limit range for storage and transport | - | -25 °C to 80 °C            |

5.2 Relative humidity may range upto 100% non- condensing.

5.3 Altitude: Up to 1000 meter above sea level.

## 6. Electrical construction Requirement

Single Phase whole current AMI Energy meter shall at least meet the following minimum and maximum limits of parameters.

### 6.1 Technical parameter of Energy Meters

Technical features		Description
<b>I. Standard Ratings</b>		
Connection type		Single-phase two-wire (1P2W), direct connection, Bi-directional measurement
Measurement accuracy		Active power: Class 1 Reactive power: Class 2
Nominal voltage (Un)		230 V
Maximum voltage		440V (max. 6 hours)
Specified operating voltage range		0.7Un ~ 1.2Un
Extended operating voltage range		0.6Un~1.2Un
Limit operating voltage range <sup>2</sup>		0.4 Un~1.2Un
Voltage failure bridging time		0.5 Seconds
Voltage restoration function standby after		5 Seconds
Reference Frequency		50 Hz ( $\pm 2\%$ )
<b>II. Electrical Requirement of Energy Meters</b>		
Current range		5(40) A, In=5A, I <sub>max</sub> =40A
Starting current		0.004 In for Active 0.005In for Reactive
Meter constant		Meter constant should be mentioned in imp/kWh and imp/kVarh
Max Temperature rise	External Surface	25° C with ambient temperature of 40°C
	Terminal	30° C with ambient temperature of 40°C
Power consumption without communication module	Voltage circuit	$\leq 2 \text{ W} / 5 \text{ VA}$
	Current circuit	$\leq 4 \text{ VA}$
<b>III. Dielectric Strength</b>		
Short time over current for 0.01 sec		30 I <sub>max</sub>
Impulse voltage with stand	At 1000 meter	8kV 1.2/50 $\mu\text{s}$
Power frequency withstand voltage		4kV AC for one minute
Creepage (Min)		20mm
Insulation resistance		$\geq 5 \text{ M}\Omega$
Clearance		8mm
<b>IV. Other requirements of Energy Meter</b>		
Display type		Segment type LCD, 8 digits, Digit height: 9mm
Energy LED		One LED for active energy, one for reactive energy

Technical features	Description	
Status LED	Refer to LED indicators chapter for the communication status indication.	
Display button	Touch type button or any suitable type so that IP-54 can be ensured.	
Communication interfaces	IR: Service Interface, Infrared optical interface, 9600bps 4G/2G communication module replaceable communication module	
	G3-PLC or 4G/2G communication module, replaceable communication module (As per tender Inquiry)	
Relay	Contact Rating: 40A 230Va.c Maximum switching power: 15kVA Maximum switching current: 60A Maximum switching voltage: 276Va.c Maximum overload current: 100A(up to 15minutes ) Electrical endurance: 10,000 ops	
Real Time Clock	IEC 62054-21 ( $\leq \pm 0.5$ sec/ day, 230Vac, 23°C)	
Electrostatic discharge	Contact discharge	8kV
	Air discharge	15kV
	Current and voltage circuits	4kV
	Auxiliary circuits	2kV
Fast transient burst	4kV	
Surge immunity	4kV	
Electromagnetic RF fields	Frequency range 80MHz to 2000MHz With current 10V/m Without current 30V/m	
Conducted disturbance	Frequency range 150kHz to 80MHz Voltage level 10V	
Radio interference (peak value)	30MHz-1GHz : 30 to 230 MHz < 30 dB( $\mu$ V) 230 to 1 000 MHz < 37 dB( $\mu$ V)	
Data retention	$\geq 15$ years	
Lifetime	$\geq 15$ years	
Backup power supply	Internal battery, external battery slot	
Payment mode	Support post-payment and prepayment mode	
Protection class acc.	Class II	
Ingress protection	IP-54 or better	
Calibration interval	Meter life-time (15 years)	

2.  $0.4U_n \sim 0.6U_n$ , the metrology shall work normally, when voltage no less than  $0.6U_n$ , all function shall be normally

## 6.2 Accuracy Features

### 6.2.1 Limits of error due to variation of the current

When the meter is under reference conditions given in clause 7.9 of IEC 62053-21 and IEC 62053-23, the percentage errors will not exceed the limits. Acceptable percentage error limits with balanced loads

Value of Current	Power Factor	Percentage error Limits for meters	
		Class 1 for active	Class 2 for reactive
$0.05 I_n \leq I < 0.1 I_n$	1.0 Resistive	±1.5	±2.5
$0.1 I_n \leq I < I_{max}$		±1.0	±2.0
$0.1 I_n \leq I < 0.2 I_n$	0.5 Inductive	±1.5	±2.5
	0.8 Capacitive	±1.5	-
$0.2 I_n \leq I \leq I_{max}$	0.5 Inductive	±1.0	±2.0
	0.8 Capacitive	±1.0	-
$0.2 I_n \leq I \leq I_{max}$	0.25 Inductive	±3.5	±2.5
	0.5 Capacitive	±2.5	-

Acceptable percentage error limits with balanced loads

### 6.2.2 Limits of error due to influence quantities

The additional percentage error due to the change of influence quantities with respect to reference conditions, as given in clause 7.10 of IEC 62053-21 and IEC 62053-23 will not exceed the limits given below:

Influence quantity	Test clause in IEC 62052-11: 2020	Specified range or value of test current (balanced unless otherwise stated)	Power Factor $\cos \phi$ (3)	Percentage error Limits for meters	
				Class 1 for active	Class 2 for reactive
Radiated, radiofrequency, electromagnetic field immunity test – test with current	9.3.5	$I_n$	1	2.0	3.0
Electrical fast transient/burst immunity test	9.3.6	$I_n$	1	4.0	6.0
Immunity to conducted disturbances, induced by radio-frequency fields	9.3.7	$I_n$	1	2.0	3.0

Influence quantity	Test clause in IEC 62052-11: 2020	Specified range or value and recommended value of test current (balanced unless otherwise stated)	Power Factor $\cos \phi$ (3)	Percentage error Limits for meters	
				Class 1 for active	Class 2 for reactive
Immunity to conducted Disturbances and signaling in the frequency range 2kHz to 150kHz at AC power ports	9.3.8	$I_n$	1	4.0	6.0
External static magnetic fields (0.7T 65*35*35mm) (5)*	9.3.12	$I_n$	1	2.0	3.0
Power frequency magnetic field immunity test	9.3.13	$I_n$	1	2.0	3.0
Harmonics in the current and voltage circuits – 5th harmonic test	9.4.2.2	0,5 $I_{max}$	1udil	0.8	1.0
Inter harmonics in the current circuit – burst fired waveform test	9.4.2.3	0,5 $I_n$	1	3.0	6.0
Odd harmonics in the current circuit	9.4.2.4	0,5 $I_n$	1	3.0	6.0
DC and even harmonics half-wave rectified waveform test	9.4.2.5	$I_{max}/1.414$	1	3.0	6.0
Voltage variation	9.4.3	$I_{min} \leq I \leq I_{max}$ ( $I_n$ )	1	0.5	1.0
		$I_n$ $0,1 I_n \leq I \leq I_{max}$	0.5	1.0	1.5
Ambient temperature Variation (2)*	9.4.4	$I_{min} \leq I \leq I_{max}$ ( $I_n$ )	1	0.05	0.10
		$0,2 I_n \leq I \leq I_{max}$ ( $I_n$ )	0.5	0.07	0.15
Interruption of phase voltage	9.4.5	$I_n$	1	2.0	4.0

Influence quantity	Test clause in IEC 62052-11: 2020	Specified range or value and recommended value of test current (balanced unless otherwise stated)	Power Factor $\cos \phi$ (3)	Percentage error Limits for meters	
				Class 1 for active	Class 2 for reactive
Frequency variation	9.4.6	$I_{min} \leq I \leq I_{max}$ ( $I_n$ )	1	0.5	2.0
		$0,1 I_b \leq I \leq I_{max}$ ( $I_n$ )	0.5	0.7	2.0
Reversed phase sequence	9.4.7	$0,1 I_n$	1	0.5	1.0
Operation of auxiliary devices	9.4.9	$I_{min}$	1	0.2	0.4
Short-time over currents (4)*	9.4.10	$I_n$	1	1.5	1.5
Self-heating (1)*	9.4.11	$I_{max}$	1	0.7	1.0
			0.5	1.0	1.5
Fast load current variations	9.4.12	$I_n$	1	2.0	3.0
Dry heat test (4)*	8.3.3	$I_n$	1	0.5	1.0
Cold test (4)*	8.3.4	$I_n$	1	0.5	1.0
Damp heat cyclic test (4)*	8.3.5	$I_n$	1	0.5	1.0

(1) The test shall be carried out for at least 1 h, or until the variation of error during 20 min does not exceed 0,2 %.

(2) These values shall be considered as mean temperature coefficients %/K for meters of class.

(3) Inductive.

(4) For these tests, the meter accuracy is measured before and after the test. The difference in percentage error before and after the test will not exceed the error limits specified in this table. These errors limits may be interpreted as allowable meter accuracy drift induced by the specified test conditions.

(5) According to the IEC standard, the mounting surface is exempted.

## 7. Mechanical Construction Requirement

### 7.1 General Mechanical Requirements

Meters shall be designed and constructed in such a way as to avoid introducing any danger in normal use and under normal conditions, so as to ensure especially

- i. Personal safety against electric shock
- ii. Personal safety against effects of excessive temperature
- iii. Protection against spread of fire
- iv. Protection against penetration of solid objects, such as thin wire. X-ray film
- v. Dust and waterproof
- vi. All parts, which are subject to corrosion under normal working conditions, shall be protected effectively. Any protective coating shall not be liable to damage by ordinary handling nor damage due to exposure to air, under normal working conditions. Meters shall withstand solar radiation.

### 7.2 Electrical Connection

The electrical connection in the energy meter shall be resistant to tempering. These shall be made so as to prevent their opening from outside the energy meter base/top cover accidentally or deliberately without breaking the seal. All the connection wires shall be equipped with sleeves.

### 7.3 Energy Meter Case

The case is comprised of cover and Base. The energy meter shall have a reasonably dust proof and moisture proof case which can be sealed in such a way that the internal parts of the energy meter are accessible only after breaking the seals. The energy meter shall comply with the degree of protection code IP-54 as per latest IEC 60529.

### 7.4 Meter Cover

The meter cover is made of UV-resistance, high impact-resistance and self-extinguishing polycarbonate (PC+10%GF). It is sealed in such a way that the internal parts of the meter are accessible only after breaking the seals. The color of the cover is grey. The material can pass a glow wire test at  $650^{\circ}\text{C} \pm 10^{\circ}\text{C}$  and duration of application is  $30 \pm 1\text{s}$ . The thickness of meter cover is 2.5mm (min).

### 7.5 Terminals and Terminal Block

#### 7.4.1 Terminal

The terminals are made of brass with tin plated ( $\geq 20$  micron) and provide two Zinc-Nickel alloy plated ( $\geq 5$  micron) carbon steel M-8 screws in each current terminal which are better protected against corrosion. The Zinc plated carbon Steel screws can pass 72 hours salt spray test according to IEC 60068. The screw is at least 3 threads in the terminals. The screw head type is Philips and slotted.

The terminal diameter size is  $11+0.3/0\text{mm}$ . The type of wires can be solid cores, composite cores or stranded wires. The terminal block is suitable for cable sleeves, see the figure as below (unit: mm):

#### 7.4.2 Terminal Blocks

The terminal block is made of UV-resistance, high impact-resistance and self-extinguishing polycarbonate (PC+20%GF), the color of the terminal block is grey, and the material can pass a glow wire test at  $960^{\circ}\text{C} \pm 10^{\circ}\text{C}$  and duration of application is  $30 \pm 1\text{s}$ .

The terminal blocks shall be robustly attached with meter base using screw or should be permanent part of meter body so that it does not show any movement between the terminal blocks by force from outside without opening of the meters cover, the design and dimension of terminal block as per drawing.

### 7.6 Terminal Cover

The terminal cover is made of UV-resistance, high impact-resistance and self-extinguishing polycarbonate (PC+10%GF) and suitable for cables incoming and outgoing vertically from the bottom, and have provision for security sealing. The connection diagram of the meters is shown on the terminal cover.

The color of the terminal cover is grey. The material can pass a glow wire test at  $650^{\circ}\text{C} \pm 10^{\circ}\text{C}$  and duration of application is  $30 \pm 1\text{s}$ .

The thickness of terminal cover is 2.5mm ( $\pm 5\%$ ).

### 7.7 **Mounting**

The meter uses three-point (A base triangle) mounting which comply with DIN 43857-3. The mounting holes accommodates 5.0 mm mounting screws. Two lower mounting holes are on both sides of the meter bottom part.

### 7.8 **Polycarbonate Material**

Polycarbonate material shall be used for fabrication of energy meter with following characteristic

- i. Pulse 10% GF
- ii. Scratch resistant
- iii. Flame retardant
- iv. Dielectric properties
- v. Ultra violet stabilized
- vi. Shall not turn yellow over the period of time

### 7.9 **Display Button**

The meter is equipped with one touch button or any other button type for scrolling display. Button type should be suitable for IP-54 protection and must not compromise IP-54 during testing and real environment.

### 7.10 **External Battery Slot**

The meter supports an external battery slot for CR2032 type, which is protected by the terminal cover

### 7.11 **Earthing Connection Arrangement**

As the energy meter base is made of insulating material, the common ground of main PCB shall be internally connected to neutral point of the terminal block.

### 7.12 **Protection against solar radiation, penetration of Dust and water , Glow wire**

The complete energy meter shall meet the requirement of IEC 620529 and following standard

- |      |                      |                |
|------|----------------------|----------------|
| i.   | Solar radiation      | IEC-60068-2-5  |
| ii.  | Penetration of water | IEC-60068-2-18 |
| iii. | Penetration of Dust  | IEC-60068-2-68 |
| iv.  | Glow wire test       | IEC-60695-2-11 |

### 7.13 **Sealing of Energy meters**

The meter has five security seals:

- i. One seal is for communication module sealing
- ii. Two seals are for terminal cover sealing
- iii. Two seals (Metrology sealing) are for the meter cover

It is impossible to touch the meter metrology part unless physically and transparently destroy the metrology seals and the meter enclosure.

The meter cover will be sealed in manufacture by the supplier, the terminal cover will be sealed on site after meter installation by the utility; in case PLC communication module, the module will be sealed in manufacture by the supplier; in case 2G/4G communication module, if physical SIM card is used, the module will be sealed on site by the utility after SIM card installation, if ESIM is used, the module will be sealed in manufacture by the supplier.

### 7.14 **METER Serial Number**

7.14.1 Each meter has a permanent, clear and unique serial number, the serial number is permanently print on the meter cover in two types, numbers and bar-code. The bar-code type is auto 128 code.

7.14.2 The meter's unique serial number is also recorded in the non-volatile memory of meter as a permanent value, which can be read out via optical port, or remote command.

7.14.3 The bar-code and the internal memory's serial number consist of 14 digits: the first 4 digits present the meter code with leading zeroes if necessary, and the next 10 digits present the unique serial number where the first two digits present the manufacture year. These 8 digits form also the serial number imprint for visual reception. The figures of the imprinted serial number shall be not less than 2.5 mm height.

7.14.4 The naming rule of meter serial number are as follows:

**MMTC YY SSSSSSS**

**MM:** Manufacturer code, it will be defined by HES provider, 01-03 is already assigned to XYZ. However New manufacturer will assigned code from -04 onward.

**T:** Metrology device type

**C:** Major communication type

*1 - G3-PLC communication*

*2 - 4/2G communication*

**YY:** The last two number code of manufacture year.

**SSSSSSS:** Device ID number, from 00000001 to 99999999

**Note:** Serial numbers on the same logic are already existing in field so after confirmation of order, Employer will share list of existing serial numbers and manufacturer will ensure that serial numbers of meters produced are different from serial numbers already existing.

**8. Energy meter Functional Characteristic**

The energy meter shall generally comprise of the following characteristic as a minimum

**8.1 Measurement/Recording**

The meter can measure active, reactive energy, maximum demand, cumulative maximum demand, and instantaneous parameters.

**8.1.1 Energy Measurement**

The meter support following energy registers:

Description	Register	
Cumulative total active energy	+A	-A
Cumulative active energy for tariff 1	+A, T1	-A, T1
Cumulative active energy for tariff 2	+A, T2	-A, T2
Cumulative active energy for tariff 3	+A, T3	-A, T3
Cumulative active energy for tariff 4	+A, T4	-A, T4
Cumulative total reactive energy	+R	-R
Cumulative reactive energy for tariff 1	+R, T1	-R, T1
Cumulative reactive energy for tariff 2	+R, T2	-R, T2
Cumulative reactive energy for tariff 3	+R, T3	-R, T3
Cumulative reactive energy for tariff 4	+R, T4	-R, T4
Cumulative reactive energy for quadrant 1	R1	
Cumulative reactive energy for quadrant 2	R2	
Cumulative reactive energy for quadrant 3	R3	
Cumulative reactive energy for quadrant 4	R4	

**8.1.2 Maximum Demand (MD)**

The meter records following MD registers:

1. Active MD total, with timestamp
2. Active MD import, with timestamp
3. Active MD import for each tariff with timestamp
4. Active MD export, with timestamp
5. Active MD export for each tariff with timestamp
6. Reactive MD import, with timestamp
7. Reactive MD import for each tariff with timestamp

8. Reactive MD export, with timestamp
9. Reactive MD export for each tariff with timestamp

The demand type is block demand.

The period of maximum demand can be configured to 10, 15, 20, 30 and 60 minutes. Default period is 30 minutes.

The demand period data will be discarded only in case demand period is changed.

When meter powers off or RTC is synchronized, the demand data will NOT be discarded.

### 8.1.3 Cumulative Maximum Demand

The cumulative maximum demand stores the sums of the corresponding maximum demand register value in all completed billing periods since the beginning of the measurement. The meter provides multiple cumulative maximum demand registers corresponding to the maximum demand registers.

1. Cumulative maximum demand  $|+A|+|-A|$  total
2. Cumulative maximum demand +A total
3. Cumulative maximum demand -A total
4. Cumulative maximum demand +R total
5. Cumulative maximum demand -R total
6. Cumulative maximum demand tariff rated register:  $|+P|+|-P|$  Tx, +P Tx, -P Tx, +Q Tx, -Q Tx (x:1~4)

### 8.1.4 Instantaneous Parameters

The meter supports following instantaneous parameters measurement:

- Voltage
- Phase Current
- Neutral Current
- Power factor
- Total active power (KWH)
- Import active KWH
- Export active KWH
- Import reactive KVARH
- Export reactive KVARH
- Current KW
- Total KW

## 8.2 Real Time Clock

- 8.2.1 The RTC complies with IEC 62052-21/62054-21. At reference voltage and reference temperature (23°C), clock accuracy is better than  $\pm 0.5$  s/day.
- 8.2.2 The RTC supports leap year, day light saving time. In case of power off, clock of meter is active for at least two years after manufactured with battery support. If the internal battery for RTC is run out and main power supply is absence, the RTC will reset to default date and time (2020-01-01 00:00:00) and meter will log RTC invalid event. However, the chronology of the measurement values can be sustained. Under RTC invalid condition, if the tariff registers are used, meter will use tariff 1 as a default setting until the date and time is synchronized.
- 8.2.3 The meter shall support broadcast clock synchronization via the DCU once a day, the broadcast synchronization features the following condition:
  - I. The meter is only allowed to receive 3 broadcast clock synchronization within one day.
  - II. The meter only accepts clock synchronization with a clock deviation within 10s to 10min, when clock deviation is less than 10s, the meter will reject the synchronization; when clock deviation is greater than 10 minutes, the meter will also reject the synchronization, and log and push the event "Clock Out Of Tolerance" to the HES. In the case, the HES needs to synchronize the meter clock point-to-point.
  - III. If meter clock is already invalid, the clock synchronization with any time deviation will be accepted by the meter. Meter time and date synchronization is possible through AMI system as well as over the optical port.

### 8.3 Backup Power Supply

- 8.3.1 The meter provides with an internal non-replaceable lithium battery as a Real Time Clock backup. The battery also support display without main power, anti-tampering features of the meters, i.e. meter cover removal detection, terminal cover removal detection, etc.
- 8.3.2 The battery is operational for the meter lifetime 15 years, and supports at least 24 months when meter without main power supply.
- 8.3.3 The meter monitors the battery status, records low battery voltage event and indicates the low battery icon on the display when the voltage of battery is lower than 80% of rated voltage of battery.
- 8.3.4 As a backup solution in some harsh environment, the meter provides an external battery slot for CR2032 type of battery on the terminal block which is protected by the terminal cover. In case the internal battery voltage is low, an external battery should be installed. The recommended and meter manufacturer verified battery brands are Panasonic, Philips, Maxell, EVE.

### 8.4 Tariff

#### 8.4.1 Normal ToU Tariff

The meter supports up to 4 tariffs (T1~T4), 24 TOU, 2 sets of tariff scheme, one is for active tariff, the other is for passive tariff. The passive tariff scheme and active date/time can be configured remotely or locally.

Each tariff scheme supports up to:

- 1) 4 seasons
- 2) 4 weeks
- 3) 4 days' profile
- 4) 24 TOU

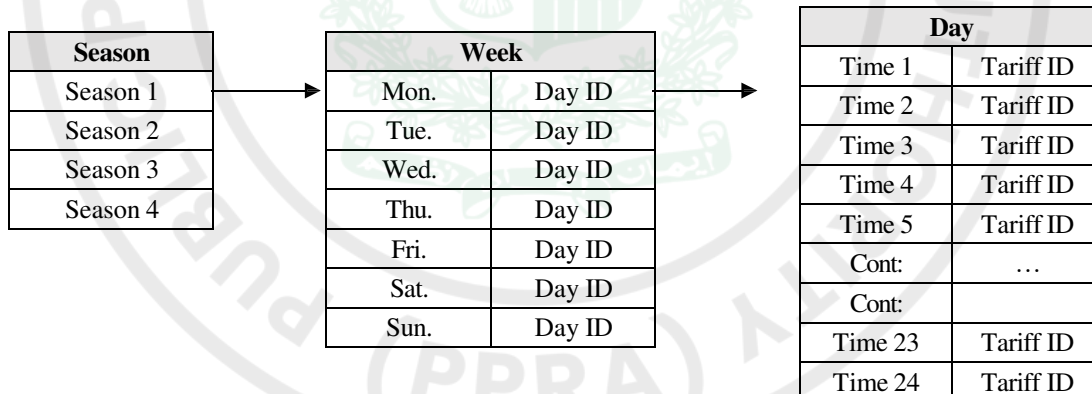

#### Tariff structure:

When doubtful / invalid RTC happens, the meter always records the energy in the default tariff T1. For the default tariff scheme configuration, please refer to Annex 2.

#### 8.4.2 Special day

- 8.4.2.1 Holidays can be defined in meters. The holidays are in conjunction with tariff activity calendar. The linking data is Day
- 8.4.2.2 ID.Special days table support a maximum of 50 entries in order to cover all fixed and flexible holidays. The date may have wildcards for repeating special days. Holidays example is as follows.

Index:	Special day date	Day ID
1	FFFF-01-01 FF	2
2	FFFF-06-10 FF	2
3	2033-11-01 FF	1
4	FFFF-12-25 FF	2

8.4.2.3 The special days are empty by default, which is configured when necessary.

## 8.5 Billing

### 8.5.1 Monthly Billing

The meter has one monthly billing profile. there are four way to trigger monthly billing

- 1) When passive tariff is activated, the meter will trigger a billing.
- 2) Automatic billing based on RTC, the billing date and time is programmable; default time is 00:00:00 of the 1<sup>st</sup> day in every month.
- 3) By a remote or local billing command.
- 4) From post-payment mode to prepayment mode, and vice versa.

The meter saves last 13 history monthly billing data. The billing objects include:

Billing Capture Objects	Status
Time stamp	Y
Billing period counter	Y
Active energy total ( +A + -A )	Y
Active energy total ( +A + -A ) T1	Y
Active energy total ( +A + -A ) T2	Y
Active energy total ( +A + -A ) T3	Y
Active energy total ( +A + -A ) T4	Y
Active energy import (+A)	Y
Active energy import (+A) T1	Y
Active energy import (+A) T2	Y
Active energy import (+A) T3	Y
Active energy import (+A) T4	Y
Active energy export (-A)	Y
Active energy export (-A) T1	Y
Active energy export (-A) T2	Y
Active energy export (-A) T3	Y
Active energy export (-A) T4	Y
Maximum Demand Active total ( +P + -P )	Y
Maximum Demand Active total ( +P + -P )-Capture Time	Y
Maximum Demand Active total ( +P + -P ) T1	Y
Maximum Demand Active total ( +P + -P )-Capture Time T1	Y
Maximum Demand Active total ( +P + -P ) T2	Y
Maximum Demand Active total ( +P + -P )-Capture Time T2	Y
Maximum Demand Active total ( +P + -P ) T3	Y
Maximum Demand Active total ( +P + -P )-Capture Time T3	Y
Maximum Demand Active total ( +P + -P ) T4	Y
Maximum Demand Active total ( +P + -P )-Capture Time T4	Y
Maximum Demand Active import (+P)	Y
Maximum Demand Active import (+P)-Capture Time	Y

Maximum Demand Active import (+P) T1	Y
Maximum Demand Active import (+P) Capture Time T1	Y
Maximum Demand Active import (+P) T2	Y
Maximum Demand Active import (+P) Capture Time T2	Y
Maximum Demand Active import (+P) T3	Y
Maximum Demand Active import (+P) Capture Time T3	Y
Maximum Demand Active import (+P) T4	Y
Maximum Demand Active import (+P) Capture Time T4	Y
Maximum Demand Active export (-P)	Y
Maximum Demand Active export (-P)-Capture Time	Y
Maximum Demand Active export (-P) T1	Y
Maximum Demand Active export (-P)-Capture Time T1	Y
Maximum Demand Active export (-P) T2	Y
Maximum Demand Active export (-P)-Capture Time T2	Y
Maximum Demand Active export (-P) T3	Y
Maximum Demand Active export (-P)-Capture Time T3	Y
Maximum Demand Active export (-P) T4	Y
Maximum Demand Active export (-P)-Capture Time T4	Y
Cumulative Maximum Demand Active total ( +P + -P )	Y
Cumulative Maximum Demand Active total ( +P + -P ) T1	Y
Cumulative Maximum Demand Active total ( +P + -P ) T2	Y
Cumulative Maximum Demand Active total ( +P + -P ) T3	Y
Cumulative Maximum Demand Active total ( +P + -P ) T4	Y
Cumulative Maximum Demand Active import (+P) total	Y
Cumulative Maximum Demand Active import (+P) T1	Y
Cumulative Maximum Demand Active import (+P) T2	Y
Cumulative Maximum Demand Active import (+P) T3	Y
Cumulative Maximum Demand Active import (+P) T4	Y
Cumulative Maximum Demand Active export (-P) total	Y
Cumulative Maximum Demand Active export (-P) T1	Y
Cumulative Maximum Demand Active export (-P) T2	Y
Cumulative Maximum Demand Active export (-P) T3	Y
Cumulative Maximum Demand Active export (-P) T4	Y
Average power factor total current month	Y
Available credit (only available in prepaid mode)	Y
Charge amount of current month (only available in prepaid mode)	Y
Current month consumption amount (only available in prepaid mode)	Y

\*Note:

1. Capture objects with symbol “\*” are not present when meter is in post-payment mode, it will automatically be added to capture objects when meter switches to prepayment mode.

2. “Y” means default capture objects of the monthly billing, “-” means the capture can be configured to monthly billing whenever needed in the future.

## 8.6 Display and Indicators

### 8.6.1 LED Indicators

Energy meter will comply following indicator

- i. One active energy pulse LED, the pulse constant
- ii. One reactive energy pulse LED, the pulse constant.
- iii. The initial status of the energy LEDs is off after power on.
- iv. One green-color LED indicates the remote
- v. communication status:

a) **For 4G Downward module:**

LED Status	Indicating Status
Off	No communication module is plugged or communication module initial
Blink 0.5s on, 3s off	No SIM card insert or SIM card cannot be detected
Blink 1s on, 0.2s off	Module network registering
Blink 1s on, 3s off	Module network registration is rejected
Blink 1s on, 1s off	Module is registered succeed, TCP connection is ongoing
Blink 0.2s on, 0.2s off	Remote communication is ongoing
On	Meter is registered succeed, no remote communication is ongoing

b) **PLC G3-PLC**

LED Status	Indicating Status
Off	No communication module is plugged or communication module fails
Blink 1s on, 1s off	Network registration is ongoing
Blink 0.2s on, 0.2s off	Remote communication is ongoing
On	Meter is registered succeed, no remote communication is ongoing

### 8.6.2 LCD Display

The meter has an 8-digits segment type LCD which with good contrast and wide viewing angle for easy meter readout. The display image area is easily readable from approximately 1 meter. The LCD supports meter's full operational temperature range, and a lifetime of the meter. The height of energy display digit is 11mm. A totally lighted up LCD screen is shown in drawings:

### 8.6.3 Display Mode

The meter supports auto scroll mode, manual scroll mode and alarm mode, power down display mode. For all the modes, the display parameters are configurable.

#### 8.6.3.1 Auto Scroll Mode

This mode is the default mode at meter power up, it automatically scrolls through all defined display elements every 5 seconds, and the interval can be configured from 1s to 60s. If only a single element is defined for the data scroll sequence, it is permanently displayed on the display. Please refer to Annex 3 for the default display objects for auto scroll mode, the display objects are also configurable.

#### 8.6.3.2 Manual Scroll Mode

User can enter Manual Scroll mode by short pressing the button. When entering the Manual Scroll mode, by short pressing the button, the meter can display all items one by one.

The meter returns to auto scroll mode from manual scroll mode automatically when no pressing button for continuous 60s, and the interval can be configured from 5s to 300s Please refer to Annex 3 for the default display objects for manual scroll mode, the display objects are also configurable.

#### 8.6.3.3 Supply Disconnection Display Mode

When the meter relay is disconnected, the meter will enter supply disconnection display mode, which help the customer to check the reason of the disconnection of power supply. Manual scroll mode can be activated by pushing the display button. When the meter relay is reconnected, the meter returns to Auto Scrolling Mode.

The possible disconnection reasons and display messages are defined as below table:

Error Description	Display Message
Meter disconnected due to meter cover removal (if enabled)	OFF-FCOV
Meter disconnected due to terminal cover removal (if enabled)	OFF-TCOV
Meter disconnected due to strong magnetic field (if enabled)	OFF-MAG
Meter disconnected due to current reverse (if enabled)	OFF-REV
Meter disconnected due to DC injection (if enabled)	OFF-DC
Meter disconnected due to ESD disturbance (if enabled)	OFF-ESD
Meter disconnected due to over current	OFF-OC
Meter disconnected due to remote operation	OFF-REMO
Meter disconnected due to overload	OFF-LOAD
Meter disconnected due to over demand	OFF-DEMD
Meter disconnected due to credit exhausted	OFF-CRDT

#### 8.6.3.4 Power Down Display Mode

The meter supports power down display mode in case of main power outage. Power down display can be activated by pressing the display button for at least 3 seconds when meter is not in low-battery status. During power down display mode, display period of each item is up to 15 seconds. If there is no display button pressing within 15 seconds, the meter will switch off the display. By pressing the display button to scroll the display items. Until the last item is displayed, meter will automatically switch off the LCD display.

During one power off period, power down display can only be activated for five times. For power down display list, please refer to Annex 3 Display Item List.

## 8.7 Payment Mode

- 8.7.1 The meter is in post-payment mode when shipped out from factory. It can be switched from post-payment mode to prepayment mode by command, and vice versa. A prepayment mode icon will be displayed on the LCD in prepayment mode.
- 8.7.2 For prepayment mode:
- 1) The meter can receive credit in kWh from the central system or local communication port.
  - 2) The meter will disconnect the power supply after credit is fully exhausted, meter will record and spontaneously report (if enabled) the disconnection event to the system.
  - 3) The meter will record and report (if enabled) the low balance alarm event to the system when the remaining credit of the meter is less than the low credit threshold which is configurable. The default low credit threshold is 10 kWh.
- 8.7.3 When the meter is switched from post-payment mode to prepayment mode at the first time, the meter will disconnect automatically because the initial available credit of the meter is 0.
- 8.7.4 The meter manages a charge sequence number to avoid the re-charge for the same command. In prepayment mode, prepayment related registers will be added in the capture objects in billing profile and daily load profile.
- 8.7.5 Prepayment related events will be logged. Refer to the 8.18 Event logs. The maximum available credit is 99999.999 kWh.

## 8.8 Load Profile

### 8.8.1 Load Profile Characteristics

Each load profile has the following characteristics:

- 1) A circular buffer is used for each load profile.
- 2) Each entry of load profile has a time stamp and load profile status word.
- 3) If power off cross capture points, the meter will only supplement the first missing points after power on.
- 4) If time is set forward crossing capture points, the meter will only supplement the first missing points.
- 5) If time is set backward crossing capture points, the meter will NOT remove redundant capture points.
- 6) The load profile supports read by time range and by entry and selectable capture objects.

### 8.8.2 Load Profile Status Word

Bit No.	Remark
Bit0	Critical error: A serious error such as a hardware failure or a checksum error has occurred. At the same time, bit 2 is set
Bit1	Clock invalid: The power reserve of the calendar clock has been exhausted. The time is declared as invalid. At the same time bit 2 is set
Bit2	Data not valid: Indicates that the current entry may not be used for billing e.g. due to time shift or if no values have been recorded during the capture period
Bit3	Daylight saving: Indicates whether the daylight-saving time is currently activated. The bit is set if the daylight-saving time is active (summer) and cleared in winter
Bit4	Reserved
Bit5	Clock is adjusted more than the synchronization limit 60s
Bit6	Reserved
Bit7	Power down: Power failure occurred

### 8.8.3 Load Profile List

i. The meter supports following load profiles:

Load Profile	Interval	Capacity
Energy load profile	Configurable range: 5/10/15/30/60 minutes (Default 60 minutes)	5760(60 minutes, 240 days)
Daily load profile	Configurable range: every 24 hours at 00:00	31(24 hours, 31 days)
Power quality load profile	Configurable range: 5/10/15/30/60 minutes (Default 60 minutes)	5760(60 minutes, 240 days)

ii. Energy Load Profile default capture objects:

No.	Default Capture Objects
1	Time stamp
2	Energy load profile status
3	Active energy total ( +A + -A )
4	Active energy import (+A)
5	Active energy export (-A)
6	Instantaneous status word

iii. Daily Load Profile default capture objects:

No	Default Capture Objects
1	Time stamp
2	Daily load profile status
3	Active energy total ( +A + -A )
4	Active energy total ( +A + -A ) T1
5	Active energy total ( +A + -A ) T2
6	Active energy total ( +A + -A ) T3
7	Active energy total ( +A + -A ) T4
8	Active energy import (+A)
9	Active energy import (+A) T1
10	Active energy import (+A) T2
11	Active energy import (+A) T3
12	Active energy import (+A) T4
13	Active energy export (-A)
14	Active energy export (-A) T1
15	Active energy export (-A) T2

No	Default Capture Objects
16	Active energy export (-A) T3
17	Active energy export (-A) T4
18	Maximum Demand Active total (+P + -P) (Daily Reset)
19	Maximum Demand Active total (+P + -P) capture time (Daily Reset)
20	Maximum Demand Active import(+P) (Daily Reset)
21	Maximum Demand Active import(+P) capture time (Daily Reset)
22	Maximum Demand Active export(- P) (Daily Reset)
23	Maximum Demand Active export(- P) capture time (Daily Reset)
24	Instantaneous status word
25	*Available credit

\* Available credit: this object is only present in prepayment mode.



**iv. Power Quality Load Profile default capture objects:**

No.	Default Capture Objects
1	Time stamp
2	Power quality load profile status
3	Average voltage L1
4	Maximum voltage L1
5	Minimum voltage L1
6	Average current L1
7	Average value of power factor

### 8.9 Relay Control

The relay of the meter can be controlled by commands or internal status of meter (e.g. prepayment balance exhausted, over power limit, tamper occurs).

The relay has three states:

Relay status	LCD display
Disconnected	Disconnected icon  is on.
Connected	Connect icon  is on.
Ready for reconnect	Disconnected icon  is blinking.

The meter use Control Mode 6, Disconnect and reconnect can be requested by:

- Remotely, via a communication command: (b)(c) remote disconnect, (d) remote reconnect;
- Locally, by a function of meter, e.g. power limiter, credit exhausted, tamper disconnection (refer to article 8.14 anti-tamper) is detected: (g) local disconnect, (h) local reconnect.
- Manually disconnect and connect are not allowed in the meter.

The chart below indicates the relay state diagram.

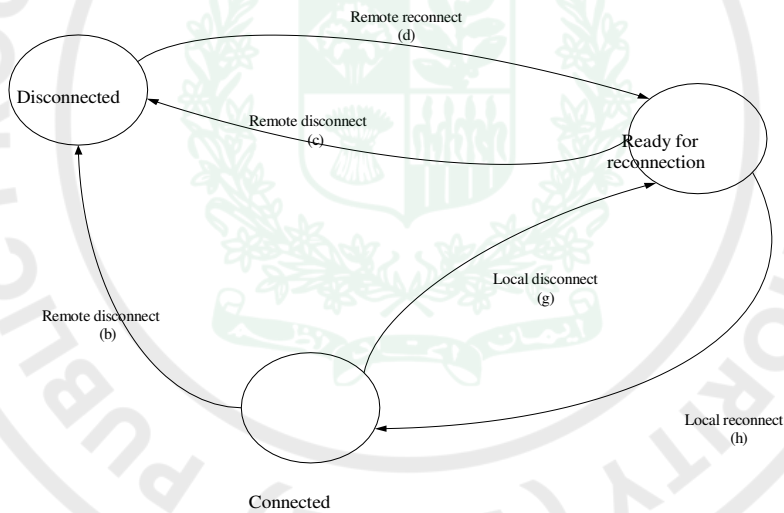

### 8.10 Power Limitation

The meter measures the total active power every second, if the active power is larger than the power thresholds for specified period  $t_1$ , the meter will disconnect the supply. After disconnection lasts for auto-reconnect time  $t_2$ , the meter will automatically connect the supply. If the customer does not reduce the load, the over load will be detected again, then the meter will disconnect the supply again. After counter of auto-reconnect reaches Max Number of Auto-reconnect, if it is disconnected once again due to over load, the meter will keep in disconnection status, only a connect command can connect the supply.

Once the meter is disconnected due to over load, the meter will show “OFF-LOAD” on the LCD. A manual display mode could be activated by pushing the display button, when the meter is timeout from the manual display mode, the meter will return back to display “OFF-LOAD”.

The meter records a counter of auto-reconnect attempt. The counter will be reset after the power withdraw below the power threshold, or after a power off, or after the credit is fully exhausted in prepayment mode, or after executing an effective supply connect command from the system or local hand-held device (when the 3 auto-reconnected process is completed and the overload status is disappeared)

Over load parameters, ranges, and default values:

Parameter	Unit	Min. Value	Max. Value	Default Value
Power threshold (P_limit)	kW	0	$U_n * I_{max} * 3 *$ 1.0	$U_n * I_{max} * 3 *$ 0.9
Time to Disconnect for P_limit ( $t_1$ )	Second	5	3600	180
Auto-reconnect Time ( $t_2$ )	Second	5	3600	180
Max. Number of Auto-reconnect	/	0	5	2

Here below picture show the load control process:

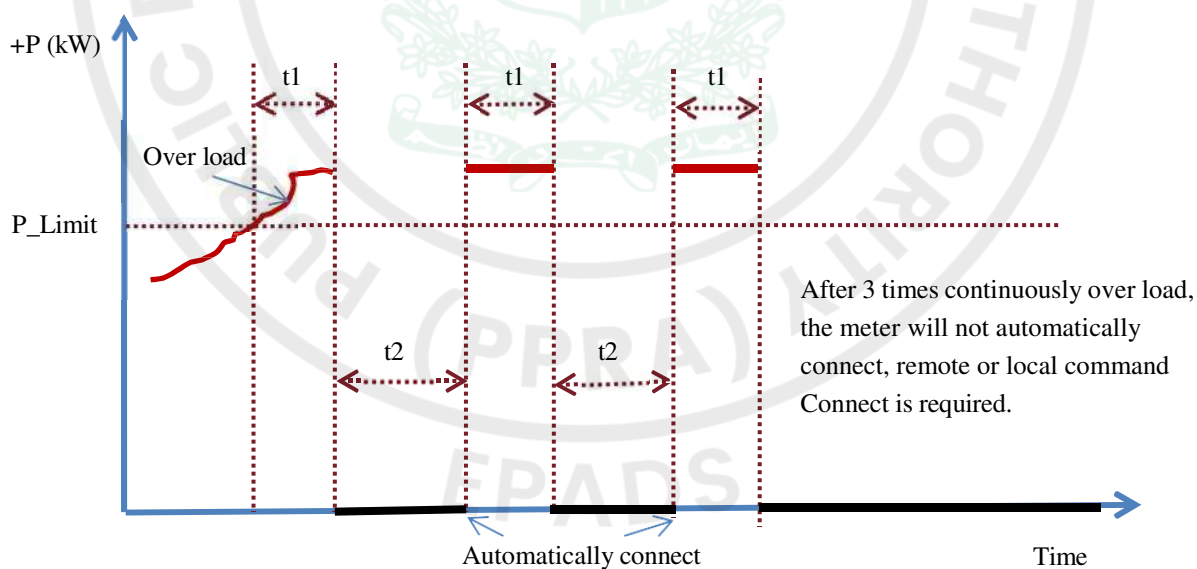

If the power threshold is zero, the relative power limitation is disabled. The demand side management function is also applicable when the meter works in prepayment mode.

During over power period, but the number of auto-reconnect has not been exceeded, after the meter is automatically reconnected, if no over power (continuous  $t_1$  time) occurs again within  $(t_1 * 2)$  seconds, the number of auto-reconnect will be reset.

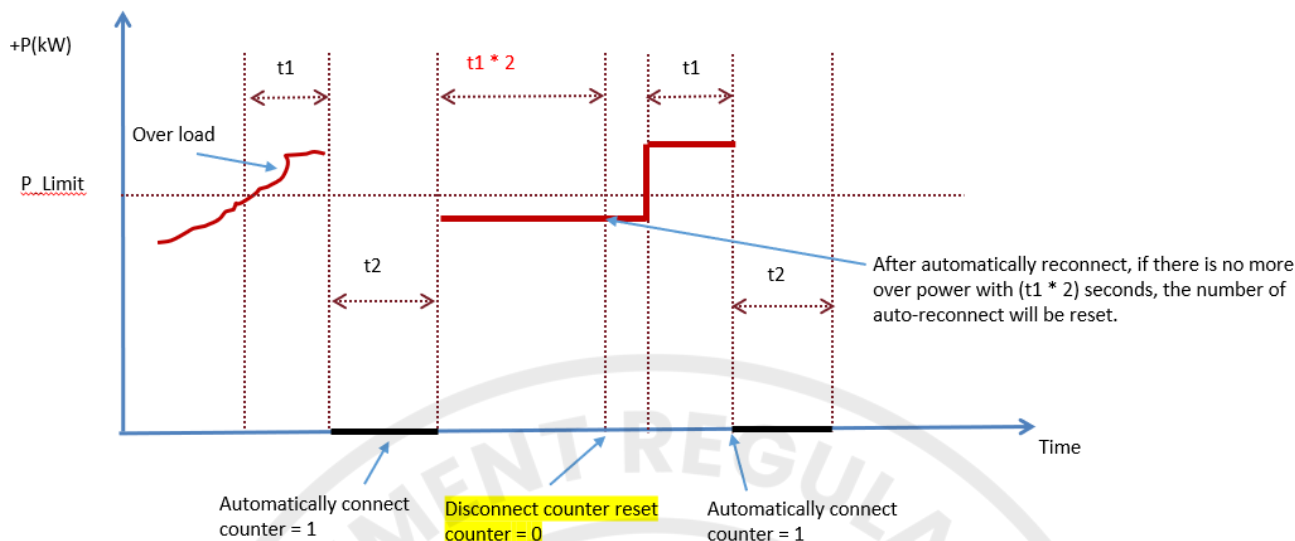

### 8.11 Over current

To protect the meter, if the current of any phase is in the range of  $(1.1 * I_{max} \sim 60A)$  for 1 minutes,, the meter will automatically disconnect the power supply. After 3 minutes, the meter will automatically reconnect the power supply. If the customer does not reduce the current, the over current will be detected again, then the meter will disconnect the power supply again. After consecutive 3 times automatic reconnection, if it is disconnected once again due to over current, the meter will keep in disconnection status, only a connect command can connect the supply.

During the disconnection period, the meter will display “OFF-OC”. When current is over 60A, the relay switching is inhibited.

The logic of over current has a separate set of  $t_1$ ,  $t_2$  and the number of auto-reconnect, which are different from Power Limitation and Demand Side Management (article 8.12).

### 8.12 Demand Side Management

The meter supports different power thresholds for up to 24 time periods. Each time period can be specified start hour time with. The last time period will be ended at 24:00. The demand side management power thresholds are configurable. The following table is an example showing different demand side management thresholds for different time periods:

Start Time (hour)	0	4	6	12	14	18	23
Power threshold (kw)	5	4	3.5	4	3.5	4	5

Table - 15 Example of demand side management thresholds

If the power threshold is zero, then there is no demand side management threshold for this period. The limitation and disconnection mechanism is same as 8.10 Power Limitation. During the disconnection period, the meter will display “OFF-DEMD” instead of “OFF-LOAD”.

But the demand side management shares the same sole set of  $t_1, t_2$  and the number of auto-reconnect which described in Table in power limitation(contract power).

The demand side management function is also applicable when the meter works in prepayment mode.

### 8.13 Export Energy Function

The meter support “Export Energy” measurement and relevant functions for distributed generation this function can be switched ON or switched OFF by command from system remotely or configure locally. “Export Energy” function is switched OFF as default.

When reverse current was detected by meter, according to “8.14 Anti-tamper” described, the current reverse event will be logged.

- I. Current reverse event is logged (ON and OFF)

When the “Export Energy” function is switched OFF, if current reverse condition occurs, the reverse current and duration time over a certain threshold which can be configured, an additional action will be performed:

- I. Disconnect relay
- II. Event “Local disconnection due to current reverse” will be logged
- III. The bit 5 “Current reverse” will be set in the Tamper status word
- IV. The LCD displays “OFF-REV”

The meter relay will reconnect when current reverse condition removed and a tamper reset command send from the HES or hand-held device. Or The “Export Energy” is switched ON remotely or locally, the tamper will be reset automatically and the relay will be reconnected.

### 8.14 Anti-Tamper

- 8.14.1 The offered type energy meter shall capable to detect tempering event which include following but not limited:

N o.	Tamper Type	Detection Threshold	Detection Duration
1	Main cover removal	Meter cover has been removed	immediately
2	Terminal cover Removal	Terminal cover has been removed	immediately
3	Strong DC magnetic Field	>200mT	The status lasts at least 5 seconds
4	ESD disturbance	>8KV	The status lasts at least 5 seconds
5	Current reverse	The direction of current and voltage of any phase is different	The status lasts at least 60 seconds
6	Current bypass	$\text{Max}(I_p, I_{ne}) \geq 20\%I_n$ , and $ I_p - I_{ne}  / \text{max}(I_p, I_{ne}) \geq 90\%$ I <sub>p</sub> : current of phase I <sub>ne</sub> : current of neutral I <sub>n</sub> : base current Max(I <sub>p</sub> , I <sub>ne</sub> ): the bigger value between phase current and neutral current	The status lasts at least 60 seconds
7	DC injection(neutral disturbance)	$V_{\text{peak}} / V_{\text{rms}} > 1.414 * (1-6\%)$ , or $V_{\text{peak}} / V_{\text{rms}} < 1.414 * (1+6\%)$	The status lasts at least 60 seconds
8	Phase sequence Reverse	The sequence of phase is wrong.	The status lasts at least 60 seconds
9	Phase & neutral Exchange	Any incoming phase and neutral has exchanged	The status lasts at least 60 seconds
10	Neutral wire cut	Neutral wire has been cut	The status lasts at least 60 seconds

- 8.14.2 The meter supports to configure if a disconnection should be applied for each kind of tamper event.

- 8.14.3 The following table shows some tamper indication and the configuration for tamper disconnection

Tamper type	Display Indication	Disconnection enabled/disabled
Meter cover removal	OFF-FCOV	Enabled
Terminal cover removal	OFF-TCOV	Disabled (after 24 hours cumulative power on or cumulative active energy exceeds 5 kWh, enabled automatically)
Strong DC magnetic field	OFF-MAG	Disabled
ESD disturbance	OFF-ESD	Disabled
Current reverse	OFF-REV	Disabled
DC injection (neutral disturbance)	DC TAMP	Disabled
Meter cover removal	OFF-FCOV	Enabled

Only the first tamper disconnection reason will be displayed if there are more than one tamper conditions are triggered.

If related tamper disconnection is disabled, even though the tamper condition is triggered, the meter will not disconnect the power supply, and the relative display indication will not be displayed, but the relative event will be logged.

### 8.15 DC Immunity

The detection condition of DC injection are shown in Figure, the meter will not saturate on passage of direct current, which can cause the meter either to stop recording/ record inaccurately. When meter detects DC injection occurrence:

- 8.15.1 If the relay disconnect function is enabled for this anti-tamper function, the meter will record the “DC injection” event, and push the event to AMI system, if the pushing of the event is enabled, display “OFF-DC”, and disconnect the power supply automatically

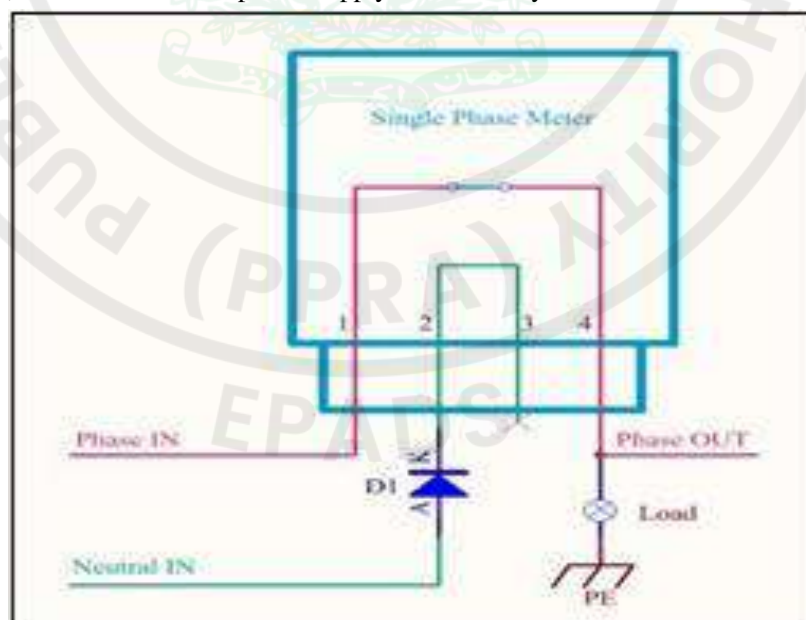

- 8.15.2 If the relay disconnect function is disabled for this anti-tamper function, the meter will record the “DC injection” event, and push the event to AMI system, if the pushing of this event is enabled, the meter will not display “OFF-DC”; user keep using energy, meter will measure energy with voltage of  $U_n$  and real current.

## 8.16 Self-diagnostics and Meter Status Word

### 8.16.1 Self-diagnostics

The meter shall be capable for self-diagnostic, which includes but not limited:

1) **Measurement system check:**

When measurement chip works abnormally, or the measurement data is not obtaining from chip, the meter will try (continuously each 5s) to restart the chip and get it to work normally, if it still doesn't work properly after 5 consecutive restart attempts, the meter will set measurement system error in instantaneous status word.

2) **Non-volatile memory check:**

The meter checks whether EEPROM and Flash works normally when meter is powered on and periodically. If error is detected, the meter will set non-volatile memory error in instantaneous status word.

3) **RAM check:**

The meter always verifies the data stored in the RAM area, if error is detected, and it will set RAM error in instantaneous status word.

4) **Program memory check:**

The meter periodically check the code area, if error is detected, the meter will set program memory error in instantaneous status word. However, the critical error icon will be displayed if critical error is detected.

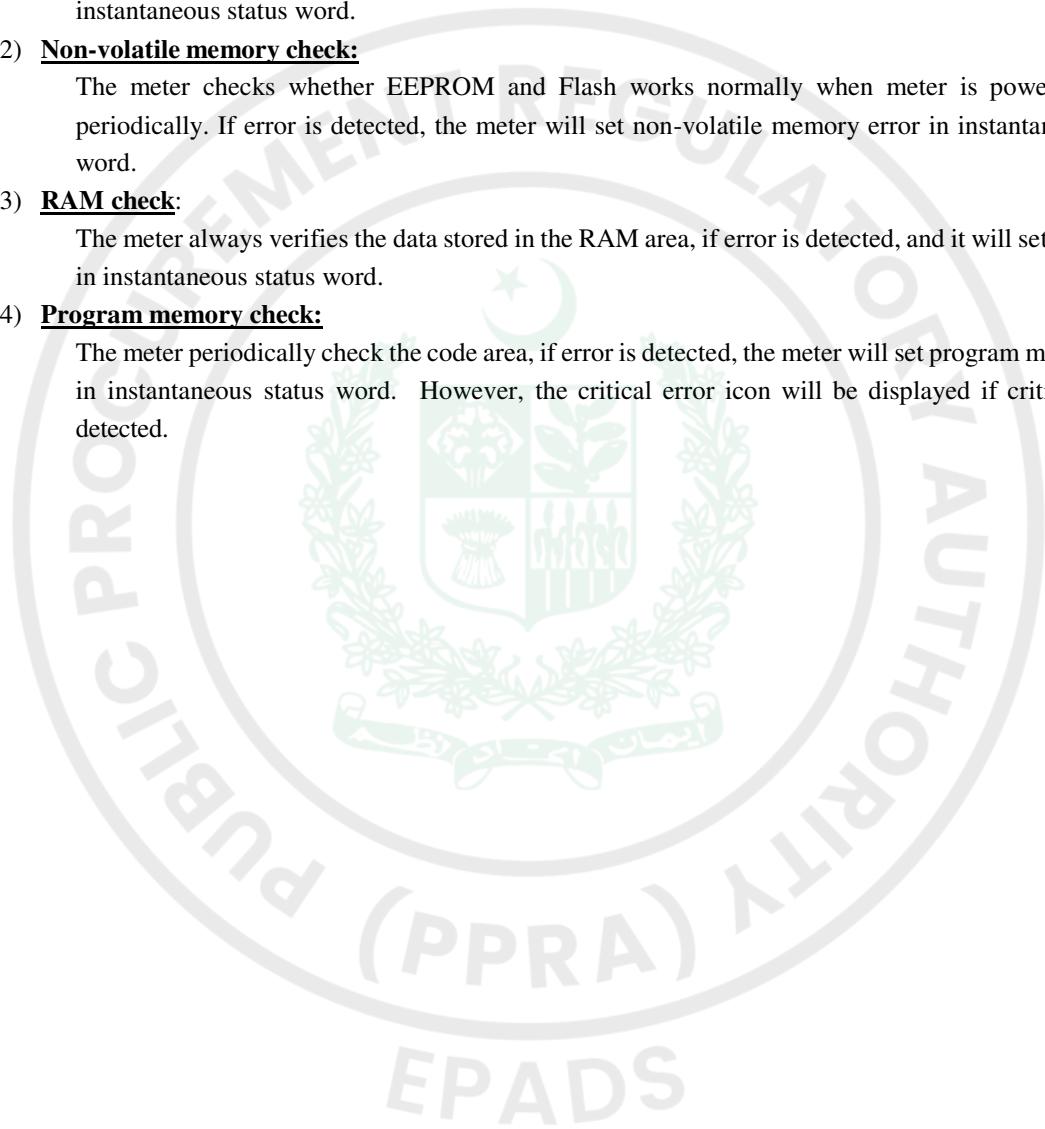

### 8.16.2 Instantaneous Status Word

A 32-bit status word is used to indicate the real-time self-diagnose and working status of the meter. It is defined as below :

Bit No.	Description	Set Condition	Reset Condition
0	Clock invalid	Meter clock is invalid	Meter clock is re-configured
1	Measurement system error	A physical error in the measurement system	The measurement system is recovered
2	NVM(non-volatile memory) error	Physical error in the EEPROM or Flash	The NVM is recovered
3	RAM error	Physical error in the RAM	The RAM is recovered
4	Program memory error	The checksum of meter code area is wrong	The checksum of meter code area is correct
5	Battery low	Battery capacity is low	Battery capacity is restored
6	Missing neutral	Neutral line is lost	Neutral line is restored
7	Phase neutral interchange	Phase & neutral line are interchanged	Phase wires are connected correctly
8	Under voltage L1	Phase L1 voltage is lower than under voltage threshold	Phase L1 voltage returns to normal
9	Over voltage L1	Phase L1 voltage is higher than overvoltage threshold	Phase L1 voltage returns to normal
10	Terminal cover removal	Terminal cover is removed	Terminal cover is closed
11	Main cover removal	Main cover is removed	Main cover is closed
12	Strong magnetic field	Strong magnetic field is detected	Strong magnetic field disappears
13	ESD disturbance	ESD disturbance is detected	ESD disturbance no longer existed
14	Current bypass	Meter is under current bypass condition	Current bypass condition is no longer existed
15	DC injection (neutral disturbance)	Neutral disturbance is detected	Neutral disturbance no longer existed
16	Current reverse	Any phase of current is reverse	All phases of current are normal
17	Relay status bit0	bit0=0, bit1=0: Disconnected bit0=1, bit1=0: Connected bit0=0, bit1=1: Ready for reconnection	
18	Relay status bit1	Terminal cover is removed	
19	Prepayment mode	Meter is in prepayment mode	Meter is in post-payment mode
20	Current without voltage	Any phase has current, but no voltage	All phases of voltage restored
21	Reserved		

### 8.16.3 Tamper Status Word

A 32-bit tamper status word is used to indicate which tampers have occurred in the meter. It can only be cleared by a clear tamper command.

Bit No.	Description	Set Condition	Reset Condition
0	Meter cover removal	Meter cover is removed	Meter cover is closed and clear tamper command is received
1	Terminal cover removal	Terminal cover is removed	Terminal cover is closed and clear tamper command is received
2	Strong magnetic field	Strong magnetic field is detected	Strong magnetic field disappears and clear tamper command is received
3	DC injection (neutral disturbance)	Neutral disturbance is detected	Neutral disturbance no longer exists and clear tamper command is received
4	ESD disturbance	ESD disturbance is detected	ESD disturbance no longer exists and clear tamper command is received
5	Current reverse	1) When Export Energy function switch OFF, if reverse current value and duration time over certain threshold, this bit will be set. 2) When Export Energy function switch ON, this bit will not be set.	1) When current reverse condition removed and tamper reset command is received 2) When Export Energy function switch ON, this bit will be reset.
6 ~31	Reserved		

## 8.17 Firmware Upgrade

The meter and communication module support to upgrade firmware remotely and locally. The firmware upgrade is protected with security level 5 of HLS (High Level Security of DLMS security suite 0). The meter verifies the integrity and originator before switching to the new firmware. The meter records the firmware upgrade related events, refer to 8.18 Event Logs.

## 8.18 Event Logs

The meter can record all the following events.

There is a register to configure which events can be pushed to the DCU/AMI system. In the following table, the column "Push" describes which events are pushed by default once they are generated.

Group	Capacity	Description	Event Generation Condition	Push	Capture Object
Standard event	50	Short Power Down		No	Event code, Timestamp
		Short Power Up		No	
		Long power down		Yes	
		Long power up		Yes	
		Daylight saving time enabled or disabled		No	
		Clock adjusted (old date/time)		No	
		Clock adjusted (new date/time)		No	
		Clock invalid		No	
		Battery low		Yes	
		TOU activated		No	
		Tamper register cleared		No	
		Program memory error		No	
		RAM error		No	
		NV memory error		No	
		Watchdog error		No	
		Measurement system error		No	
		Firmware ready for activation		No	
		Firmware activation failed		No	
		Firmware activated		No	
		FW verification failed		No	
		Passive TOU programmed		No	
Clock out of tolerance		There is a big difference between the time value issued by DCU or the AMI system and meter clock	Yes		
Global key(s) changed			Yes		
Load profile cleared			No		
Event log cleared			No		
Fraud event	50	Terminal cover removed		Yes	Event code, Timestamp
		Terminal cover closed		Yes	
		Strong DC field detected		Yes	
		No strong DC field anymore		Yes	
		Meter cover removed		Yes	
		Meter cover closed		Yes	
		ESD start	8kV ESD disturbance is detected	Yes	
		ESD end	ESD disturbance tampering no longer exists	Yes	
		Current Reversal L1		Yes	
		Current Reversal L1 end		Yes	
Communication module removed		No			

		Communication module inserted		No	
		DC injection (neutral disturbance) start		No	
		DC injection (neutral disturbance) end		No	
		Phase neutral exchange start		No	
		Phase neutral exchange end		No	
		Current bypass start		No	
		Current bypass end		No	
		Current without voltage start	Neutral wire is not connected on the meter	No	
		Current without voltage end		No	
		Event log cleared		No	
Communication event	50	Communication start on local interface		No	Event code, Time stamp, client ID, communication port ID(1:optical;2: remote)
		Communication end on local interface		No	
		One or more parameters changed		No	
		Communication problems	a. Rejected DLMS "association-request" in the meter with errors different from authentication failure b. Unauthorized meter communication attempt (Rejected DLMS "association-request" failure due to incorrect credentials)	Yes	
		Configuration problems	a. Rejected DLMS "set-request" in the meter. b. Rejected DLMS "Action-request" in meter (including FW upgrade)	Yes	
		Decryption or authentication failure (n time failure)		No	
		Replay attack	The invocation counter in the data frame receive by the meter is equal to or smaller than which stores in the meter.	No	
Disconnect control event	50	Event log cleared		No	Event code, Timestamp
		Remote disconnection		No	
		Local disconnection due to over power		Yes	
		Local disconnection due to meter cover removal		Yes	
		Local disconnection due to terminal cover removal		Yes	
		Local disconnection due to over demand side threshold		Yes	
		Local disconnection due to strong DC magnetic field		Yes	
		Local disconnection due to DC injection		Yes	
		Local disconnection due to current reverse		Yes	
		Local disconnection due to ESD disturbance		Yes	
		Local disconnection due to over current		Yes	
Local disconnection due to credit exhausted		Yes			

		Power limiter threshold exceeded (contract power limit and demand side limit)		No	
		Power limiter threshold ok		No	
		Demand side limiter threshold exceeded		No	
		Demand side limiter threshold ok		No	
		Power limiter threshold configured		No	
		Demand side threshold configured		No	
		Local reconnection		Yes	
		Over current start	The phase current is bigger than current threshold in the meter	Yes	
		Over current end	The phase current is lower than current threshold in the meter	Yes	
Power quality event log	50	Under voltage L1		No	Event code, Timestamp
		Overvoltage L1		No	
		Voltage L1 normal		No	
		Event log cleared		No	
Prepayment event log	50	Low credit	Meter available credit is lower than low credit threshold	Yes	Event code, Timestamp
		Switch to prepayment mode		No	
		Switch to post-payment mode		No	
		Credit exhausted		Yes	
		Configure low credit threshold		No	
		Clear recharge sequence number		No	
Recharge event log	50	Recharge		No	Timestamp, Recharge sequence number, Recharge amount
Communication module event log	100	P2P: No connection timeout		No	Event code, Timestamp
		P2P: Modem SW reset		No	
		P2P: SIM Card failure		No	
		P2P: SIM Card ok		No	
		P2P: Network registration failure		No	
		P2P: PDP context established		No	
		P2P: PDP context destroyed		No	
		P2P: PDP context failure		No	
		P2P: Modem reset timer expired		No	
		P2P: Signal quality low		No	
		P2P: Modem listen failed		No	
		P2P: Modem communication ready		No	
		P2P: TCP connection establish failed		No	
		P2P: Image download succeed		No	
		P2P: Image download failed		No	
		P2P: Image upgrade succeed		No	
		P2P: Image upgrade failed		No	
		PLC: No connection timeout		No	
		PLC: Modem SW reset		No	
		PLC: Modem Registration Success		No	
		PLC: Modem Registration Failure		No	
		PLC: Modem Kicked		No	
		PLC: Modem HW Reset		No	
PLC: Modem Request to Reset		No			
PLC: Modem Initialize Failure		No			

	PLC: Modem Data Request Failure		No	
	PLC: ICMP RA Received		No	
	PLC: ICMP RS Failure		No	
	PLC: ICMP Echo Request Received		No	
	PLC: PAN Conflict Detected		No	
	PLC: No PAN Detected		No	



## 9 Communication Interfaces

The meter provides two communication interfaces, one for local communication, the other for remote communication. The remote communication port supports plug and play 4G/2G communication module or G3-PLC communication module, and other kind of communication technologies for future extension. The details of the communication ports are defined as below:

Purpose	Interface	Baud Rate	Protocol latest Relies
Local communication	Optical port	9600 bps	DLMS/COSEM, HDLC profile
Remote communication	4G Downward communication	Downlink: max. 10M bps Uplink: 5M bps	DLMS/COSEM,, TCP/IP Profile.
	G3-PLC communication	200 kbps maximum in D8PSK mode	DLMS/COSEM, TCP/IP Profile.

The optical port locates on the basic meter. All communication parameters and data are stored in the meter. Multi-channels (i.e.: optical port, remote port) can communicate simultaneously.

### 9.1 Optical Port Communication

The optical port is used for reading meter configuration, meter parameter or control the meter locally. In general, a hand-held device is used to communicate with meter via this optical port.

### 9.2 Remote Communication

The remote communication module can be 4G/2G communication module, or G3-PLC communication module.

### 9.3 4G/2G Communication

The key features of 4G/2G are listed in below table:

<b>General Function</b>	<b>Performance &amp; Availability</b>	<ul style="list-style-type: none"> <li>- FDD-LTE CAT1 B1/B3/B5/B8</li> <li>- GPRS 900/1800 MHz</li> <li>- Control via AT commands</li> <li>- Operation temperature: -25°C to +80°C</li> <li>- Max transmit power:                             <ul style="list-style-type: none"> <li>LTE CAT1 B1/B3/B5/B8: 23±2.7dBm</li> <li>GPRS 900M/1800M: 33dBm/30±2dBm</li> </ul> </li> <li>- Support reconnection behavior after detecting an unexpected interrupted Communication session.</li> </ul>
	<b>Roaming</b>	Support national roaming between 4G/2G networks of different national telecom providers. Support SIM cards with multiple IMSI.
	<b>SIM</b>	Support 2FF SIM card. Specially, the recommended thickness is 0.76mm. Support IMEI lock of the USIM card. Support ESIM card.

	<b>Indications of 4G/2G signal Strength</b>	Indicate 4G/2G signal strength in a minimum of 4 separate levels. Refer to LCD display. RSRP, RSRQ value is readable.
	<b>Antenna</b>	Internal antenna
<b>Access and connection</b>	<b>Wake-up</b>	Support fully qualified domain names. Receive and store the IP addresses of the primary and secondary address when establishing a PDP context based on the DHCP protocol Support data pushing.
	<b>Authentication and security</b>	Changeable APN/password Support RADIUS authentication using PAP or CHAP. Network access information is not saved on the SIM cards Communication settings to be remotely configurable
	<b>Assign IP address</b>	4G downward module support both dynamic IP address assignment and static IP Address

Description of 4G/2G communication

The 4G/2G communication parameters are configurable, generally programmed in the factory.

A communication LED is used to indicate the communication status, refer to 8.6.1 LED Indicators for details.

For the detailed information of 4G/2G communication module, please refer to the 4G/2G module's technical specification.

## 9.4 G3-PLC Communication

The key features of G3-PLC are list below:

1. Communication frequency: FCC band
2. Auto-repeater, network self-healing
3. Meter auto-registration
4. Meter can work as repeater
5. MAC-layer security
6. Support broadcast firmware

upgrade Technical features:

1. Modulation: (ROBO1/4)/DBPSK/DQPSK/D8PSK
2. Frequencies: FCC : 154.687 kHz to 487.5 kHz
3. Max data rate: FCC: DBPSK: 77.2 kbps, DQPSK: 166.4 kbps , D8PSK:152.899 kbps
4. Power consumption
  - ✓ Standby: < 30mA@15V
  - ✓ Communication: <200mA@15V(average)
  - ✓ Transmit peak :700mA@15V

A communication LED is used to indicate the communication status, refer to 8.6.1 LED Indicators for details.

For the detailed information of G3-PLC communication module, please refer to the G3-PLC module's technical specification.

### 9.4.1 Physical Features

The dimension of 4G/3G module is(L×W×H) 97.2mm×64.6mm×36.6mm(±2mm).

The module has 15.0V±5% (DC) power supply coming from the meter with a maximum pulse current consumption of 850mA.

The module communication interface to the Meter using UART interface.

The module is equipped with a SIM card holder, supporting 1.8V/3V USIM card.

### General View of communication Module

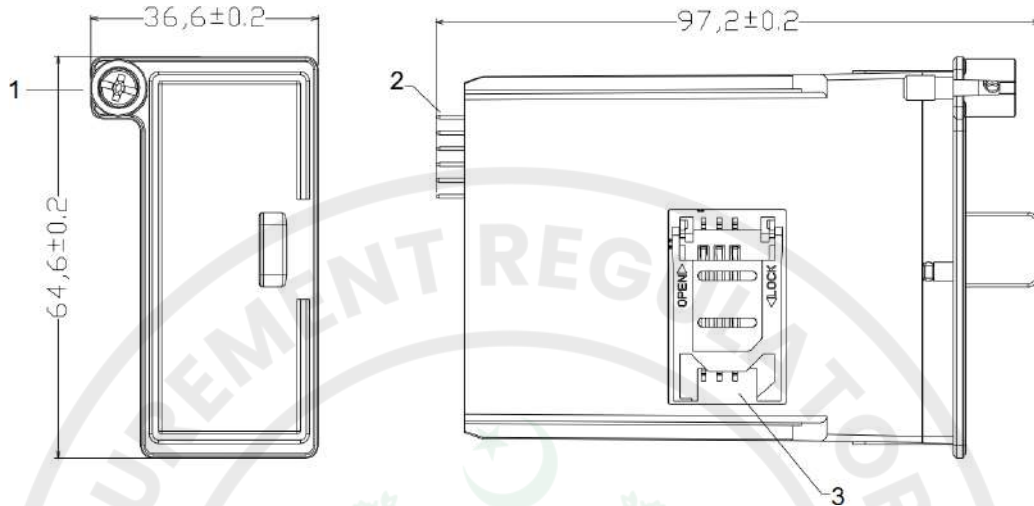
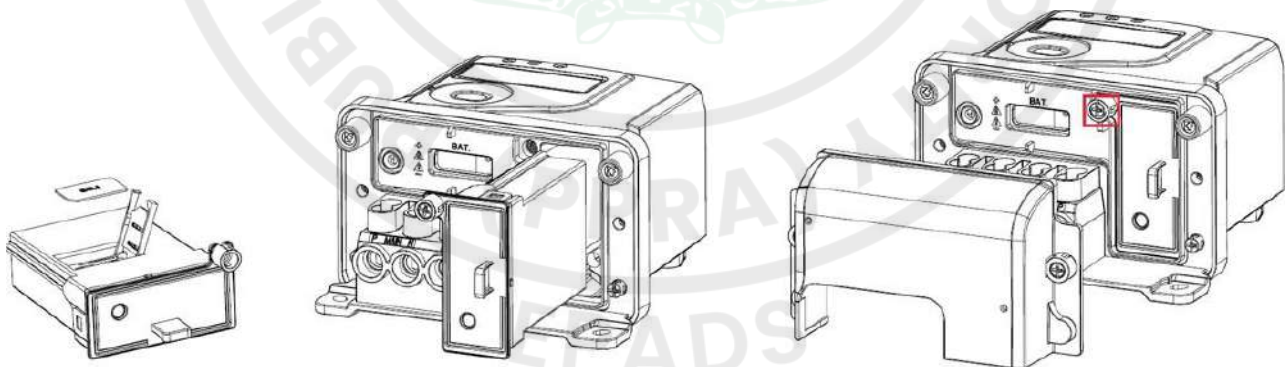

Figure - General view of 4G/2G module

- 1. 4G/2G module sealing screw
- 2. DC power supply and UART interface
- 3. SIM card socket

### Mounting of communication module

The module is installed in a plastic housing and mounted inside the meter with sealing screw.



Step1. Insert SIM card

Step2. Insert module to meter

Step3. Install the seal and terminal cover

Figure - Default mounting point for Single-phase meter

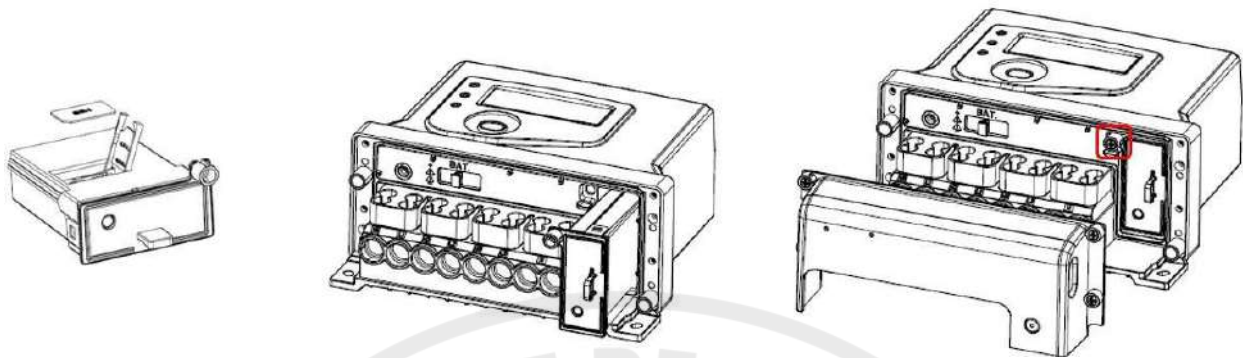

Step1. Insert SIM card

Step2. Insert module to meter

Step3. Install the seal and terminal cover

Figure - Default mounting point for Single-phase meter

## 9.4.2 Function

### 9.4.2.1 Data Transmission

The module data transmission adopts the wireless transmission mode, and the 4G/2G wireless transmission network is used as the communication medium to realize the reading, monitoring and control of the meter. The system can realize the acquisition and verification of the meter data, the monitoring of the power quality and the working state of the meter, and the remote control of the meter. The transmission process not only ensure the security of data, but also take into account the transmission efficiency.

### 9.4.2.2 4G/2G Module Communication Status Display

One green-color LED on the meter indicates the 4G/2G module communication status:

LED Status	Indicating Status
Off	No communication module is plugged or communication module fails
Blink 0.5s on, 3s off	No SIM card insert or SIM card cannot be detected
Blink 1s on, 0.2s off	Module network registering
Blink 1s on, 3s off	Module network registration is rejected
Blink 1s on, 1s off	Module is registered succeed, TCP connection is ongoing
Blink 0.2s on, 0.2s off	Remote communication is ongoing
On	Meter is registered succeed, no remote communication is ongoing

Table - Communication status of 4G/2G module

The wireless signal strength of 4G/2G module can be easily readout through the meter LCD.







Number/Symbol	Description
	On: 4G/2G module is inserted in the meter Off: 4G/2G module is not detected.
	Displays the 4G/2G signal strength:  RSSI < -120 dBm (Very poor Signal)  -120 dBm ≤ RSSI < -100 dBm (Poor Signal)  -100 dBm ≤ RSSI < -90 dBm (Bad signal)  -90 dBm ≤ RSSI < -80 dBm (Good signal)  RSSI ≥ -80 dBm (Excellent signal)

Table - Description of wireless signal strength on meter LCD screen

### 9.4.2.3 Firmware Upgrade of communication module

The communication module support to upgrade firmware remotely. FOTA (Firmware Over-The-Air) upgrade mode is adopted. In-flight download software upgrade of module refers to providing firmware upgrade services for modules through cloud upgrade technology. Users can obtain intelligent terminal system upgrade packages on demand and perform cloud upgrade through FOTA. Complete system repair and optimization.

### 9.4.3 SIM Card

#### SIM Card Technical Features

The SIM card provided by the operator needs to meet the following requirements, to get the best performance.

<b>Temperature</b>	Operation temperature: -25°C to +80°C
<b>Dimensions</b>	Plug-in Card(2FF): length 25mm, width 15mm, thickness <b>0.8±0.08mm</b> Do not use Micro or Nano SIM card
<b>Voltage</b>	3.0V and 1.8V
<b>Reliability</b>	Industrial grade card Meet 1000 hours of dual 85 testing (85°C and 85% humidity)

Table - SIM Card Technical Features

#### 9.4.3.1 External antenna module

When the signal in the area where the meter is located in poor signal area and the build-in antenna module signal cannot communicate, supplier shall provide an external antenna module to replace the build-in antenna module for the meter.

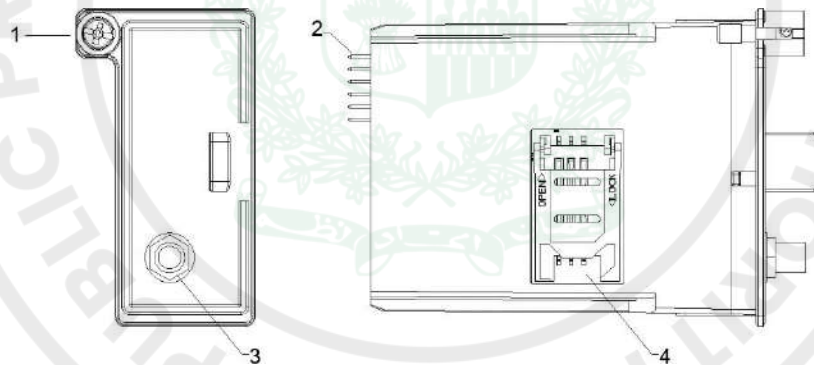

Figure - 4 General view of 4G/2G external antenna module

1. 4G/2G module sealing screw
2. DC power supply and UART interface
3. SMA external antenna interface
4. SIM card socket

There have a SMA pre-cut hole design on meter terminal cover, the hole with a pre-cut on the terminal cover as a default configuration, if the meter with PLC module, and 4G/2G modules with built-in antennas, the pre-cut hole will be kept.

In case of a external antenna 4/2G module is equipped, the pre-cut hole on the terminal cover should be removed for external antenna installation.

**FOR SINGLE PHASE METER:**

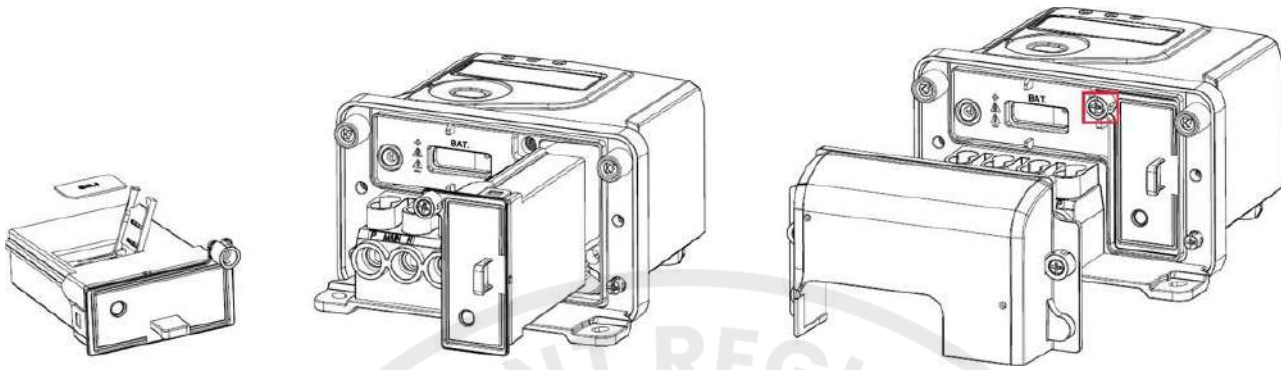

Step 1. Insert SIM card

Step 2. Insert module to meter

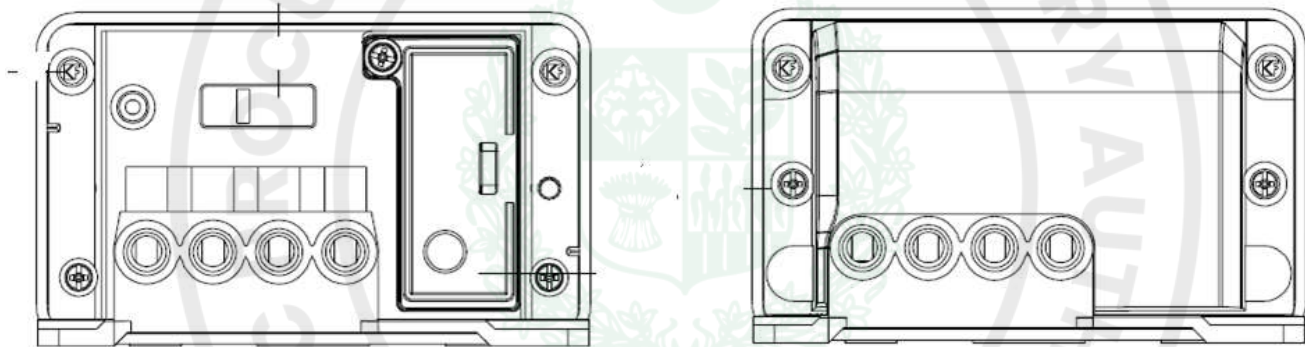

Step 3. Connect external antenna through terminal cover and put the rubber plug into the hole on terminal cover

Step 4. Install the module seal, and install terminal cover

Figure – 5 External antenna installation for Single -phase meter

## 10 Security

### 10.1 Physical Security

The meter has two seals for the meter cover to seal the metrology part of the meter. It is impossible to access the meter metrology part unless physically and transparently destroy the metrology seals or meter enclosure. The meter detects and records the meter cover removal event and terminal cover removal event in both power on condition and power off condition. The meter immune magnetic field disturbance and records the strong magnetic field event.

The meter has a unique serial number, which is recorded in non-volatile memory of meter, and marked on the name plate of the meter permanently, and is not possible to change once out of factory. The memory serial number can be displayed in the LCD in Manual Scroll Mode.

### 10.2 Communication Security

The meter supports DLMS security suite 0 defined in DLMS Green Book Edition 10, High Level Security (HLS) mechanism id 5 with both authentication and encryption is used to ensure the data privacy and security in data communication.

The meter supports a Role-Based Access Control (RBAC). Each role has its own access privileges. Here below table lists all the roles, their privileges, security mechanism:

Role	Client ID	Privileges	Security Mechanism
Public	16	Read limited meter information, like the meter serial number.	No
Readout	2	Read meter.	HLS Mechanism id 5 AES-GCM-128
Management	1	Read meter, configure meter, meter key change	HLS Mechanism id 5 AES-GCM-128
Maintenance	6	Read meter, configure meter	HLS Mechanism id 5 AES-GCM-128
Pre-established	102	Event push	No

Table - Description of each role

When the connection to the local port fails, or “action-request”, “set-request” fails, the meter will record the corresponding event, which refers to chapter 5.13 Communication Event for specified events.

### 10.3 Keys

The meter has the following keys for each DLMS HLS client.

No	Type Name	Description
1	Authentication key	Ensure data integrity and authenticity
2	Encryption key	Ensure data confidentiality
3	Master key	Use to change other keys

Table - Description of keys

Each meter has its own individual keys once out of factory. All keys stored in the meter is encrypted. The key can be changed by key change command from AMI system.

## 11 TESTS:

Procedure of inspection for Local Manufacturers regarding Routine, Sample and Type Tests as per requirements of IEC standards.

### 11.1 Routine Testing

Following routine tests shall be carried out by the manufacturer on each energy meter and witnessed by the Inspector as per respective clauses of IEC 62053-21 and IEC 62053-23.

1) - Visual inspection

ii) - Accuracy Test

iii) - Starting Current test

**If failure exceeds than 5%, the group offered for routine inspection shall be rejected.**

In order to improve the quality and workmanship, after the successful Routine Testing and welding of the energy meters, the displayed quantities kWh, kVARh and kW of each energy meter must be recorded and retained for the official record by the manufacturer for at least One (01) Year.

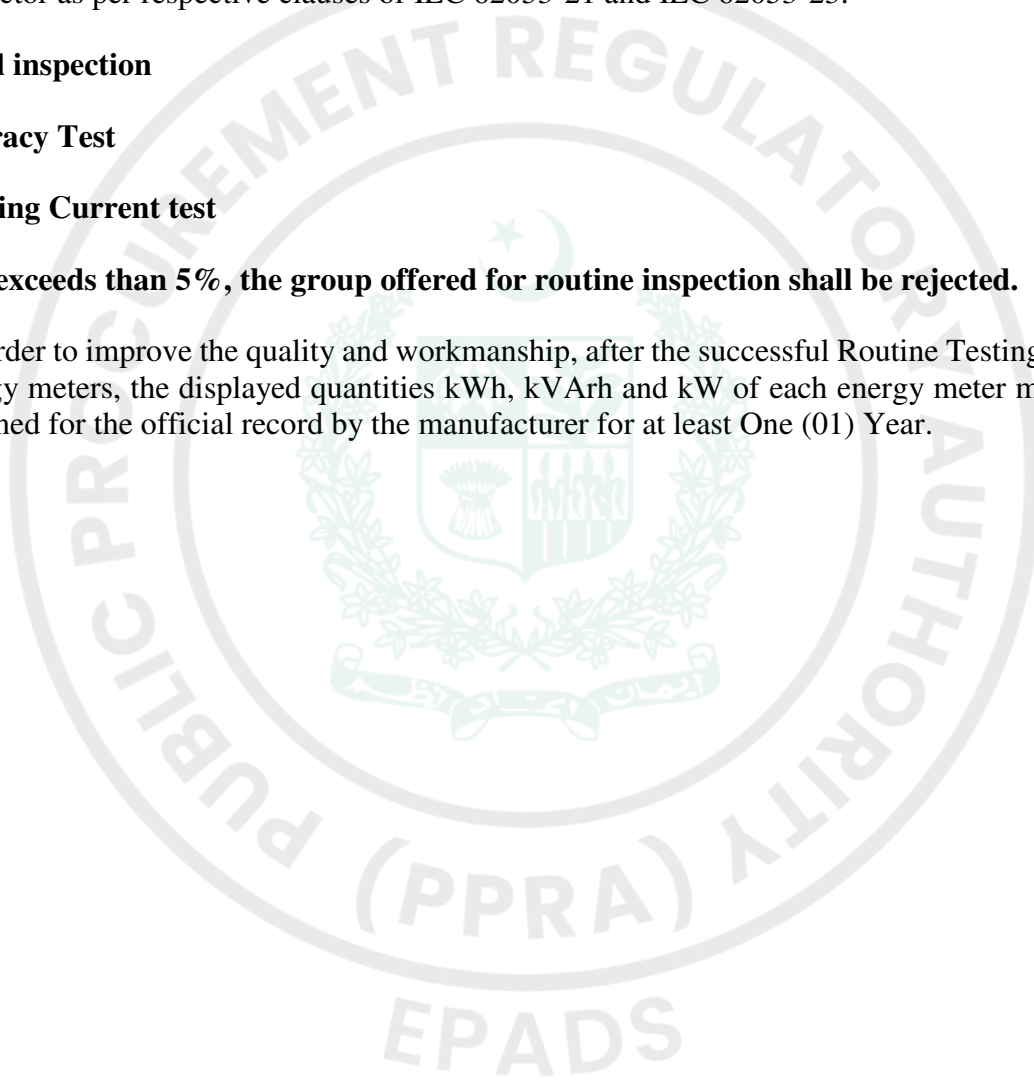

### 11.2 Sample Testing, Acceptance and Rejection

The energy meter offered for acceptance shall be grouped into lots containing up to 1000 energy Meters. A sample comprising Five (05) energy meters shall be selected at random from each lot and Subject to following Test.

Clause	Test Description	Samples Drawn	Acceptance	Resampling	Rejection
	<b>VISUAL INSPECTION</b>				
	<b>ELECTRICAL TESTS</b>				
i.	Test of Accuracy due to variation of Current	05 Nos.	Lot shall be accepted, If ONE meter fails in ANY ONE of the tests.	Resampling of the same size should be carried out, If ONE meter fails in any of the TWO tests or TWO meters fail in any ONE test	The lot shall be rejected, If THREE or MORE meters fail in any of the test or ONE meter fails in any THREE or MORE tests or ONE meter fails in any TWO tests and ONE meter fails in ONE test
ii.	Test of Starting Condition				
iii.	Test of No Load Condition				
iv.	Impulse Voltage Test				
v.	AC Voltage Test	02 No. already selected			
vi.	Power Loss Test				
vii.	Influence of DC and Even Harmonics Test				
	<b>EMC Tests</b>				
viii.	Fast Transient Burst Test	Other 02 No. already selected			
ix.	Test of Immunity to Electrostatic Discharge				
x.	Surge Immunity Test				

MECHANICAL TESTS				
i.	Shock and Vibration Test	01 No. on which EMC tests have already been performed (Once in P.O)		
ii.	Test of Protection against Penetration of Dust and Water	02 Nos. on which electrical tests already performed		
iii.	Dimensional Check and Verification of Components	01 No. on which Extreme		
iv.	Impact Test & Tin Coating Tests	Temperature test already performed		
v.	Extreme Temperature Condition Temperature = 80 °C for 04-Hours $V_{ref} = 230$ Volts, $I_{max} = 100$ Amps.  Meter shall be energized with reference Voltage and Maximum Current ( $I_{max}$ ) be flown continuously for Four (4) hours. During the test, accuracy of energy meter should be within the specified limits, which shall determine its qualification in test.	01 No. remaining out of 05 meters	The lot shall be accepted, if all meters QUALIFY all the tests	In case, If any meter fails in the RELEVANT test, another sample of DOUBLE the size shall be selected and test be repeated.
<b>Software and Security Verification</b>				
vi.	Radar Magnet Test			
vii.	Verification of Security Features			
viii.	Accuracy with and without Neutral			
ix.	<b>Software Verification</b> Verification of functionality of Software and Display Features shall be performed by loading/downloading and auditing of the reports. (Copy of the report be retained for official record).	01 No. on which EMC tests have already been performed		

### 11.3 Type Test

Each type smart Energy meter is acceptable subject to type testing requirement as criteria laid down below duly witnessed by one Engineer of TSW and One AMI Meter specialist at cost and arrangement of manufacturer. The validity of Type test report shall be five year depend upon the field performance of meter. In case change in specification or design by manufacturer then manufacturer will carry out fresh type testing as criteria laid down below.

Sr.No	Description	Lab
<b>1</b>	<b>Electrical Test</b>	Any IEC/IEEE registered Lab. However, order of testing shall be as per IEC standard
1.1	Identification of Type and designation	
1.2	Power consumption of voltage circuit.	
1.3	Power consumption of current circuit	
1.4	Voltage dips and short interruptions	
1.5	Short time over current.	
1.6	Influence of self-heating	
1.7	Short circuit withstand	
1.8	Impulse withstand test	
1.9	Power frequency withstand test	
1.10	Accuracy test for active and reactive	
1.11	Influence quantities	
1.12	Starting condition	
1.13	No load condition.	
<b>2</b>	<b>Accuracy requirements</b>	
2.1	Meter constant	
2.2	Initial start-up of the meter	
2.3	Test of no-load condition	
2.4	Starting current test	
2.5	Repeatability test	
2.6	Limit of error due to variation of the current	
2.7	Time-keeping accuracy	
2.8	Test of time-keeping accuracy on operation reserve	
2.9	Test of time-keeping accuracy with temperature	
2.10		
<b>3</b>	<b>Tests for electromagnetic compatibility (EMC) and limits of error due to electromagnetic influence quantities:</b>	
3.1	immunity to electrostatic discharges	
3.2	immunity to electromagnetic hf fields	
3.3	transient burst test	
3.4	radio interference measurement	
3.5	Voltage dips and short interruptions	
3.6	Electrostatic discharges	
3.7	Radiated, radio-frequency, electromagnetic field immunity test – test without current	
3.8	Radiated, radio-frequency, electromagnetic field immunity test – test with current	
3.9	Electrical fast transient/burst immunity test	
3.10	Conducted disturbances induced by radio-frequency fields	

<b>4</b>	<b>Test for immunity to conducted, differential mode disturbances and signaling in the frequency range 2 kHz to 150 kHz at AC power ports</b>	ILAC registered independent lab
4.1	Surge immunity test	
4.2	Ring wave immunity test	
4.3	Power frequency magnetic fields of external origin	
4.4	Conducted emission	
4.5	Radiated emission	
<b>5</b>	<b>Tests of immunity to other influence quantities</b>	
5.1	Harmonics in the current and voltage circuits – 5th harmonic test	
5.2	Inter harmonics in the current circuit – burst fired waveform test	
5.3	Odd harmonic in the current circuit	
5.5	DC and even harmonic – half-wave rectified waveform test	
5.6	Voltage variation	
5.7	Ambient temperature variation	
5.8	Interruption of phase voltage	
5.9	Frequency variation	
5.10	Reversed phase sequence	
5.11	Operation of auxiliary devices	
5.12	Short-time over currents	
5.13	Self-heating	
5.14	Fast load current variations	
<b>6</b>	<b>Mechanical Test</b>	
6.1	Spring Hammer Test	
6.2	Shock Test	
6.3	Vibration Test	
6.4	Heat and Fire resistance test	
6.5	Dust and Water (IP) test	
<b>7</b>	<b>Climate &amp; Environmental Test</b>	
7.1	Dry Heat Test	
7.2	Cold Test	
7.3	Damp Heat Cycle Test	
7.4	Solar Radiation Test	
7.5	Humidity Test	
7.6	Protection against spread of fire	
7.7	Temperature test	
7.8	Protection against penetration of dust	
7.9	Protection against penetration of water	
<b>8</b>	<b>Communication Test</b>	
<b>8.1</b>	Provision of documents for Type Approval from PTA along with 01 Nos. Samples.	

## 11.4 Pre-Shipment Inspection:

The successful bidder shall offer the meters for testing/inspection, Procedure for pre-shipment inspection is given below:

S.No	Test Description
1	Impulse voltage test
2	AC voltage test
3	Insulation Test
4	Accuracy Test due to variation of current
5	Test on starting Condition
6	Test of no-load condition
7	Power Loss Test
8	Influence of DC& Even Harmonic Test
9	Fast Transient Burst Test
10	Test of immunity to electrostatic discharge
11	Surge immunity Test
12	Shock and Vibration test
13	Test of protection against penetration of dust and water
14	Dimensional check and verification of Component
15	Spring hammer test
16	Tin coating Test
17	Extreme Temperature Condition ,temperature 80Cfor 4 hour ,Vref=230V,Imax=100A
18	Radar Magnet Test
19	Accuracy with and without Neutral
20	Software Verification Test
21	Communication Test ,read Data From HES, Operating Relays from HES

## 12 Name and Rating Plate

A suitable name/rating plate shall be provided inside at the front of the meter, indicating the following information:

- Name of the manufacturer and country of origin.
- Type of meter.
- Number of phases and number of wires.
- Nominal and maximum current, nominal voltage and frequency.
- Symbol of class insulation
- Disco Name
- Meter constant.
- P.O. No.
- Meter No. and Year of manufacturer.
- Warranty upto
- IP Protection Class
- Relevant DDS/IECs Standard
- Property, not for sale.
- Display sequence should be printed on nameplate.
- ERP SAP item code no.
- Accuracy Class For Active and Reactive Energy
- Connection Diagram
- Normal mode parameters
- Any others necessary information in case of Bi-directional and AMI Metering
- Meter Terminal Box shall not be opened as it'll disconnect the supply. (English/Urdu)

## 13. Sample for interoperability

In order to ascertain interoperability of meter with communication system, & OBIS, the most advantageous Bidder, before award of contract, shall submit at least three number samples of meter. The employer will issue certificate for the same in case of compatibility tests passed from Employer's lab. In case of failure of interoperability tests, IESCO will issue deficiency report to manufacturer for rectification and improvement. After improvement, manufacturer will submit rectified sample to IESCO for testing of interoperability. If sample does not qualify the tests again the bidder will be declared non-responsive. Bidder will bear cost of interoperability test one time.

## 14. Accessories

Each meter will be supplied with following accessories

I:Connection sleeve

II:Nut bolts

## 15. Packing

Each meter shall be individually packed in thermo pore packing or thermo pore lined packing, covered with adhesive tape at joints or plastic strips etc.

The packing shall be strong enough to withstand rigors of ocean, rail, road etc.

## 16. Warranty

The supplier shall provide 02(Two) years Warranty from date of meter installation and 04 Years from the date of the delivery (which ever comes earlier) for the Successful operation of the Energy Meters including its maintenance as and when required.

## 17. AMI Mobile Application:

Mobile application is also part of the scope, so the supplier should also provide it. The IR interface is as under:

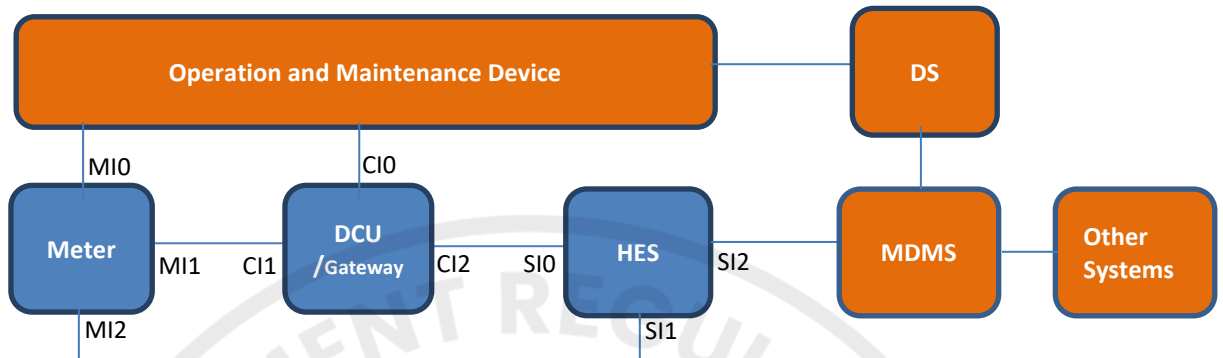

Figure 1: Interface Architecture

1. Meter must have optical port which comply with IEC 62056-46, refer to the interface architecture, the MI0 interface is based on IEC 62056-46 direct HDLC profile.
2. The baud rate shall be at least 9600 bps.
3. All read-out procedures need to be compliant to DLMS / COSEM.
4. The optical port supports to connect to Smart App/Laptop through USB type A or Type C

## Annexure:

### Annex 1 Reference Standards

The meter complies with the following standards.

#### 1. Metering Standards

No.	Standard	Release time
1	IEC 62052-11 Electricity metering equipment – General requirements, tests and test conditions – Part 11: Metering equipment	2020
2	IEC 62052-31 Electricity metering equipment (AC) – General requirements, tests and test conditions – Part 31: Product safety requirements and tests	2015
3	IEC 62053-21 Electricity metering equipment – Particular requirements – Part 21: Static meters for AC active energy (classes 0,5, 1 and 2)	2020
4	IEC 62053-23 Electricity metering equipment – Particular requirements – Part 23: Static meters for reactive energy (classes 2 and 3)	2020
5	EN50470-1 Electricity metering equipment (a.c.) — Part 1: General requirements, tests and test conditions — Metering equipment (class indexes A, B and C)	2006
6	EN50470-3 Electricity metering equipment (a.c.) — Part 3: Particular requirements — Static meters for active energy (class indexes A, B and C)	2006

#### 2. Electrical Testing Standards

No.	Standard	Release time
1	IEC 61000-4-2 Electromagnetic compatibility (EMC) – Part 4-2: Testing and measurement techniques – Electrostatic discharge immunity test	2008
2	IEC 61000-4-3 Electromagnetic compatibility (EMC) - Part 4-3: Testing and measurement techniques - Radiated, radio-frequency, electromagnetic field immunity test	2006
3	IEC 61000-4-4 Electromagnetic compatibility (EMC) - Part 4-4: Testing and measurement techniques - Electrical fast transient/burst immunity test	2012
4	IEC 61000-4-5 Electromagnetic compatibility (EMC) - Part 4-5: Testing and measurement techniques - Surge immunity test	2017
5	IEC 61000-4-6 Electromagnetic compatibility (EMC) - Part 4-6: Testing and measurement techniques - Immunity to conducted disturbances, induced by radio-frequency fields	2013
6	IEC 61000-4-8 Electromagnetic compatibility (EMC) - Part 4-8: Testing and measurement techniques - Power frequency magnetic field immunity test	2009
7	IEC 61000-4-11 Electromagnetic compatibility (EMC) - Part 4-11: Testing and measurement techniques - Voltage dips, short interruptions and voltage variations immunity tests	2020
8	IEC 61000-4-12 Electromagnetic compatibility (EMC) – Part 4-12: Testing and measurement techniques – Ring wave immunity test	2017

9	IEC 61000-4-19 Electromagnetic compatibility (EMC) - Part 4-19: Testing and measurement techniques - Test for immunity to conducted,	2014
---	--	------

No.	Standard	Release time
	differential mode disturbances and signaling in the frequency range 2 kHz to 150 kHz at a.c. power ports	
10	IEC 61000-4-30 EMC Part 4-30 Testing and measurement techniques – Power quality measurement methods 2015-02 150P	2015
11	IEC 62053-61 Electricity Metering Equipment (a.c.) - Particular Requirements - Part 61 Power Consumption and Voltage Requirements	1998
12	IEC 62058-11 Electricity metering equipment (AC) - Acceptance inspection - Part 11: General acceptance inspection methods	2008
13	IEC 62058-31 Electricity metering equipment (AC) – Acceptance inspection – Part 31: Particular requirements for static meters for active energy (classes 0.2S, 0.5S, 1 and 2)	2008

### 3. Mechanical Testing Standards

No.	Standard	Release time
1	IEC 60068-2-6 Environmental testing – Part 2-6: Tests – Test Fc: Vibration (sinusoidal)	2007
2	IEC 60068-2-27 Environmental testing – Part 2-27: Tests – Test Ea guidance: Shock	2008
3	IEC 60068-2-5 Environmental testing – Part 2-5: Tests – Test Sa: Simulated solar radiation at ground level and guidance for solar radiation testing, IDT	2018
4	IEC 60695-2-11 Fire hazard testing – Part 2-11: Glowing/hot-wire based test methods –Glow-wire flammability test method for end-products	2014
5	DIN 43857-2 Electricity meters in insulation housings for direct connection up to 60A limit current main dimensions for three-phase current meters	1978

### 4. Environmental Standards

No.	Standard	Release time
1	IEC 60068-2-1 Environmental testing – Part 2-1: Tests – Test A: Cold	2007
2	IEC 60068-2-2 Environmental testing – Part 2-2: Tests – Test B: Dry Heat	2007
3	IEC 60068-2-30 Environmental testing – Part 2-30: Tests – Test Db: Damp heat, cyclic (12 h + 12 h cycle)	2005
4	IEC 60529 Degrees of protection provided by enclosures (IP Code)	2013
	IEC 62059-32-1 Electricity metering equipment – Dependability – Part 32-1: Durability – Testing of the stability of metrological characteristics by applying elevated temperature	2011

**5. Software Standards**

No.	Standard	Release time
1	IEC 62052-21 Electricity metering equipment (a.c.) - General requirements, tests and test conditions Part 21: Tariff and load control Equipment	2004
2	IEC 62054-21 Electricity metering (a.c.) - Tariff and load control - Part 21: Particular requirements for time switches	2004
3	IEC 62056-21 Electricity metering – data exchange for meter reading, tariff and load control – Part 21 Direct local data exchange	2002
4	IEC 62056-46 Electricity metering – Data exchange for meter reading, tariff and load control - Part 46: Data link layer using HDLC protocol	2007
5	IEC 62056-53 Electricity metering - Data exchange for meter reading, tariff and load control - Part 53 Part: COSEM Application layer	2006
6	IEC 62056-61 Electricity metering - Data exchange for meter reading, tariff and load control - Part 61 Part: Object identification system (OBIS)	2006
7	IEC 62056-62 Electricity metering - Data exchange for meter reading, tariff and load control - Part 62: Interface classes	2006

**6. PLC communication Standards**

No.	Standard	Release time
1	EN-50065-1 2011 Signaling on low-voltage electrical installations in the frequency range 3KHz to 148.5KHz - Part 1: General requirements, frequency bands and electromagnetic disturbances	2011
2	ITU-T G.9903 2014 Narrowband orthogonal frequency division multiplexing power line communication transceivers for G3-PLC Networks	2014

**7. 2/4G communication Standards**

No.	Standard No.	Title
1	3GPP Release 13 LTE Cat.1bis	-
2	ETSI TS 102 221	Smart Cards; UICC-Terminal interface; Physical and logical characteristics (Release 15)

**8. Electrical Standards**

No.	Standard No.	Title
1	IEC 62054-21	Electricity metering equipment(a.c.)-General requirements, tests and test conditions-Part 21: Tariff and load control equipment
2	EN55032:2015/A1:2020	Electromagnetic compatibility of multimedia equipment - Emission Requirements
3	EN55035:2017	Electromagnetic compatibility of multimedia equipment - Immunity requirements
4	IEC 60068-2-1:2007	Environmental testing-Part 2-1: Tests-Test A: Cold
5	IEC 60068-2-2:2007	Environmental testing-Part 2-2: Tests-Test B: Dry heat
6	IEC 60529 2013	Degrees of protection provided by enclosures (IP Code)
7	IEC 62052-31 2015	Electricity metering equipment (AC) General requirements tests and test conditions Part 31 Product safety

## 9. Module Configuration List

Module supports configurations of the following parameters for network functions via DLMS protocol.

Item	Class	Obis Code	Attri	Description
Modem setup	45	0-0:25.4.0.255	2	Configuration for APN
			3	Configuration for Pin Code
PPP setup	44	0-0:25.3.0.255	5	Configuration for PPP_authentication, include username and password
TCP-UDP setup	41	0-0:25.0.0.255	6	Configuration for TCP Inactivity timer, if no TCP traffic and the timer is timeout, TCP connection for reading is released.
Auto connect (For push)	29	0-0:2.1.0.255	3	Configuration for Push retry times
		0-0:2.1.0.255	4	Configuration for Push retry interval
		0-0:2.1.0.255	6	Configuration for Push address, support both IP and domain name
FOTA	1	0-1:94.31.22.255	2	Configuration for FOTA URL
	9	0-2:10.0.1.255	2	Configuration for FOTA enable

APN: It's a network access technology and APN is a parameter that must be configured when accessing the Internet through a module.

PinCode: Personal Identification Number, The PIN code of the SIM card is a security measure to protect the SIM card and prevent others from stealing the SIM card. Usually, the PIN code is default disabled. If the PIN code is enabled, a four digits PIN code is needed for inputting for verification after SIM card has power supply first time.

PinCode is enabled or disabled, it depends on the SIM card suppliers. PPP\_authentication

## Annex 2 Default Tariff Scheme

The default tariff scheme is as follows.

### 1. Calendar name

Calendar_name
cale

### 2. Season tariff

Season_profile_name	Season_start	Weekly Profile Name
B	FF-03-01 FF	week_2
C	FF-06-01 FF	week_3
D	FF-09-01 FF	week_4
A	FF-12-01 FF	week_1

### 3. Week tariff

Weekly_profile_name	Monday	Tuesday	Wednesday	Thursday	Friday	Saturday	Sunday
week_1	1	1	1	1	1	1	1
week_2	2	2	2	2	2	2	2
week_3	3	3	3	3	3	3	3
week_4	4	4	4	4	4	4	4

### 4. Day tariff

Day_id	Start-time	Tariff
1	17:00:00	T1
	21:00:00	T2
2	18:00:00	T1
	22:00:00	T2
3	19:00:00	T1
	23:00:00	T2
4	18:00:00	T1
	22:00:00	T2

## Annex 3 Display Item List

The display list of meter should be configurable from system side in case of receiving command to do so. The display lists are different for meter in uni-directional and bi-directional mode. Each mode has three display types i.e. auto, manual and power down display mode. The default display objects for auto scroll mode details for both uni-directional and bi-directional categories are as under:

Index	OBIS	Description	Format	Unit
1	/	Display all segment	All segments	/
2	96.1.0	Device ID1, manufacturing number	XXXXXXXXXX	/
3	15.8.0	Active energy total ( +A + -A )	XXXXXXXXXX	kWh
4	15.6.0	Monthly Maximum Demand Active total ( +P + -P )	XXXXXX.XXX	kW
5	13.24.0	Average power factor of current month	X.XXX	/
6	15.7.0	Instantaneous active power total ( +P + -P )	XXXXXX.XXX	kW
*7	19.0.0	Available credit	XXXXXX.XXX	kwh

\*7: Available credit: this item will not appear when meter in post-payment mode, when meter is switched to prepayment mode, it will be automatically added to the scroll list.

The default display objects for manual scroll mode are described as follows:

Index	OBIS	Description	Format	Unit
1	/	Display all segment	All segments	/
2	96.1.0	Device ID1, manufacturing number	XXXXXXXXXX	/
3	0.9.1	Local time	HH:MM:SS	/
4	0.9.2	Local date	DD-MM-YY	/
5	32.7.0	Voltage	XXX.X	V
6	31.7.0	Current	X.XX	A
7	13.7.0	Power factor	X.XXX	/
8	14.7.0	Frequency	XX.XX	Hz
9	1.7.0	Instantaneous active power total ( +P + -P )	XXXXXX.XXX	kW
10	15.8.0	Active energy total ( +A + -A )	XXXXXXXXXX	kWh
11	15.8.1	Active energy total ( +A + -A ) T1	XXXXXXXXXX	kWh
12	15.8.2	Active energy total ( +A + -A ) T2	XXXXXXXXXX	kWh
13	15.6.0	Monthly Maximum Demand Active total ( +P + -P )	XXXXXX.XXX	kW
14	15.6.1	Monthly Maximum Demand Active total ( +P + -P ) T1	XXXXXX.XXX	kW
15	15.6.2	Monthly Maximum Demand Active total ( +P + -P ) T2	XXXXXX.XXX	kW
16	15.2.0	Monthly Cumulative Maximum Demand Active total ( +P + -P )	XXXXXX.XXX	kW
17	15.2.1	Monthly Cumulative Maximum Demand Active total ( +P + -P ) T1	XXXXXX.XXX	kW
18	15.2.2	Monthly Cumulative Maximum Demand Active total ( +P + -P ) T2	XXXXXX.XXX	kW
19	96.10.6	instantaneous status word	HEX format	/
20	96.10.7	Tamper status word	HEX format	/
21	0.1.0	Billing period counter	XXX	/
22	15.6.0.1	Maximum Demand Active total ( +P + -P ), for last month	XXXXXXXXXX	kWh
23	15.6.0.1	Maximum Demand Active total ( +P + -P ), data time, for last month	DD-MM-YY HH-MM-SS	/
24	13.24.12	Average power factor of current month	X.XXX	/
*25	19.0.0	Available credit	XXXXXX.XXX	kwh

*26	41.129.0	Last recharge kwh	XXXXXX.XXX	kwh
*27	40.129.5	*Monthly consumption energy (import active energy) for last month	XXXXXXXXXX	kWh

\*25(Available credit), \*26(Last recharge kwh), \*27(Monthly consumption energy): these items will not appear when meter in post-payment mode, when meter is switched to prepayment mode, it will be automatically added to the scroll list.

The default display objects for power down display mode are described as follows:

Index	OBIS code	Description	Format	Unit
1	96.1.0	Device ID1, manufacturing number	XXXXXXXXXX	/
2	15.8.0	Active energy total ( +A + -A )	XXXXXXXXXX	kWh
*3	19.0.0	Available credit	XXXXXX.XXX	kwh

\*3: Available credit: this item will not appear when meter in post-payment mode, when meter is switched to prepayment mode, it will be automatically added to the scroll list.

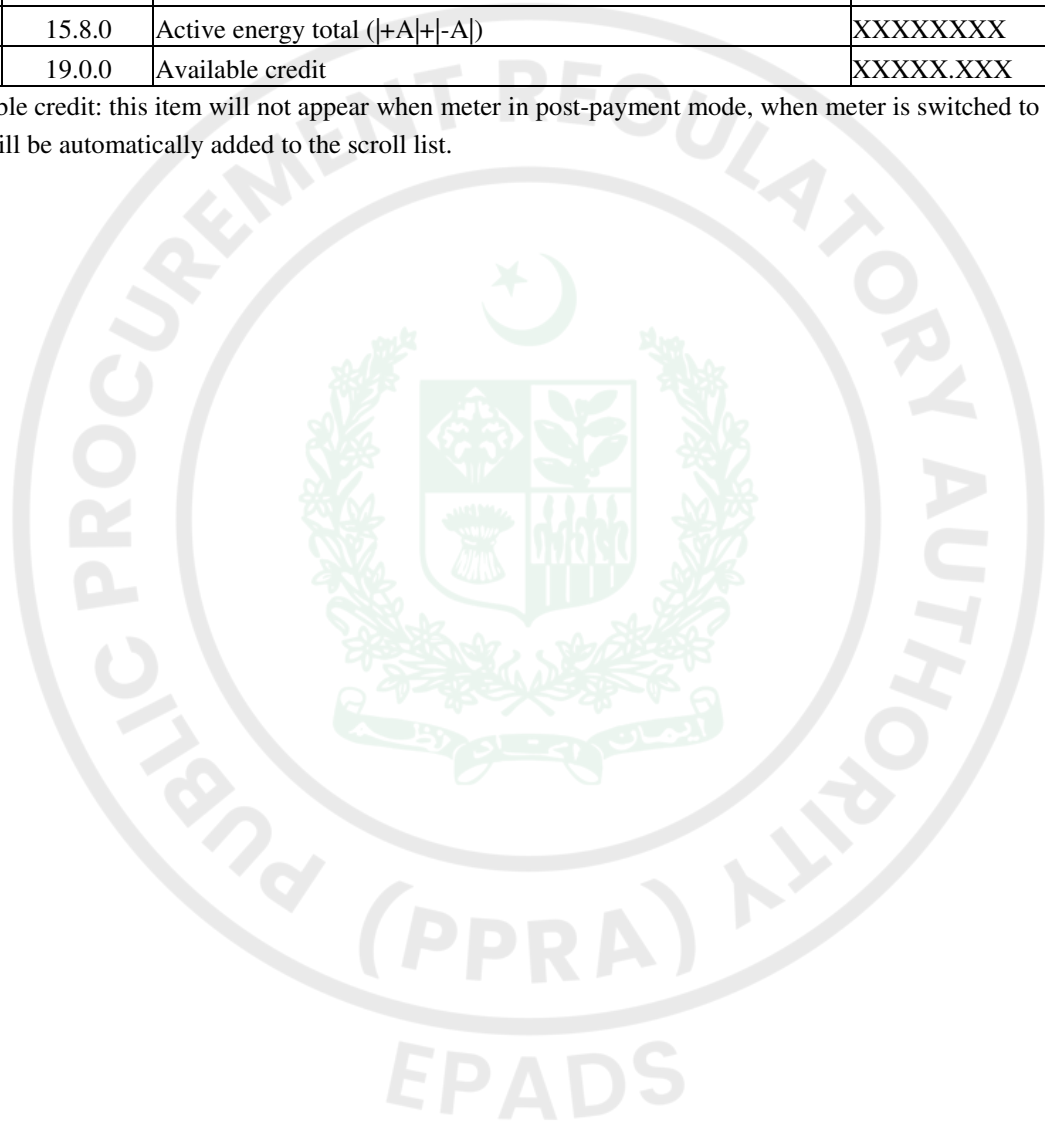

## Annex 4 Smart Meter Companion Specification (Annexed to Specs)

Companion Specifications are designed to ensure proper communication of meter with the system. The parameters defined in this companion specification will be tested in detail on sample provided by bidder.

### 1 Overview

This document describes communication profiles for the communication interfaces of the AEM meter based on DLMS/COSEM data model. It is applicable for single phase meter, three phase direct connection meter, three phase CT meter, and three phase CT/PT meter.

This document is only used for meter interoperability to HES system for the AMI project.

### 2 Normative References

#	Ref.	Title
1	DLMS UA 1000-2 Ed. 10: 31 August 2020	DLMS/COSEM Architecture and Protocols, the —Green Book
2	DLMS UA 1000-1 Ed. 14: 31 August 2020	COSEM Identification System and Interface Classes, the —Blue Book
3	IEC 62056-21 Ed. 1.0:2002	Electricity metering – Data exchange for meter reading, tariff and load control – Part 21: Direct local data exchange
4	IEC 62056-46 Ed. 1.1:2007	Electricity metering – Data exchange for meter reading, tariff and load control – Part 46: Data link layer using HDLC protocol
5	IEC 62056-53 Ed. 2.0:2006	Electricity metering – Data exchange for meter reading, tariff and load control – Part 53: COSEM Application layer
6	IEC 62056-61 Ed. 2.0:2006	Electricity metering – Data exchange for meter reading, tariff and load control – Part 61: Object identification system (OBIS)
7	IEC 62056-62 Ed. 2.0:2006	Electricity metering – Data exchange for meter reading, tariff and load control – Part 62: Interface classes

Table: references

### 3 Abbreviations

Abbreviation	Description
AEM	Advanced Electricity Meter
MDMS	Meter Data Management System
HES	Head End System
DCU	Data Concentrator Unit
HHU	Hand-Held Unit
DLMS	Device Language Message Specification
COSEM	Companion Specification for Electricity Metering
OBIS	Object Identification System
IC	Invocation Counter
G3-PLC	G3-PLC supporting IPv6
HDLC	High-level Data Link Control
HLS	High Level Security
APDU	Application Layer Protocol Data Unit
RLRQ	A-Release Request – an APDU of the ACSE
LTE	Long Term Evolution
SAP	Service Access Point

Table :Abbreviations

## 4 System and Interface Architecture

The following chart illustrates the components and interface of the AMI system.

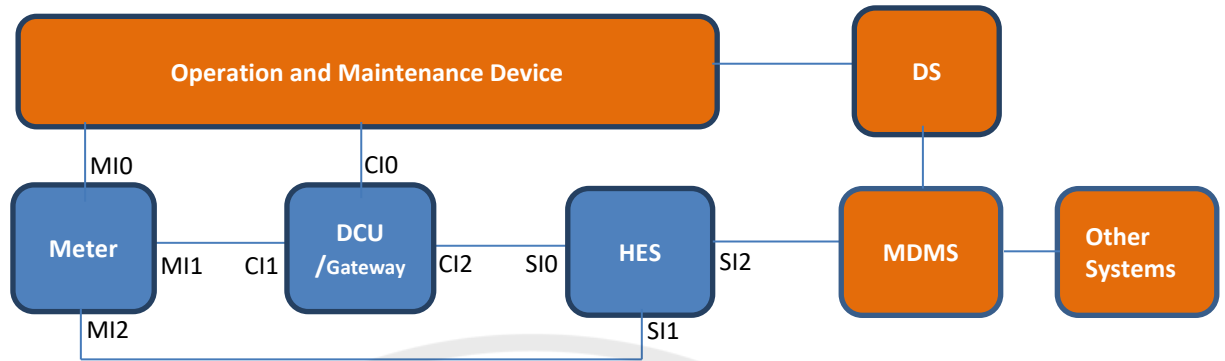

Figure 2: System and Interface Architecture

The AMI system includes:

- 1) HES system: Head-End System. The HES consists of SIO interface to DCU, SII interface to electricity meter, and SII interface to MDMS.
- 2) MDMS: Meter Data Management System.
- 3) DCU or Gateway: Data Concentrator Unit or Gateway. DCU is used to collect and manage the information from meters, and send the information to the HES system. It also transfers the request from HES to the meters, and transfers the response from meter to HES. Gateway does not store the data from meter or HES, which is different from DCU. DCU/Gateway has a CIO interface for local maintenance, a CII interface to meters, a CII interface to HES system. The CIO interface can be optical port or RS-232 serial port, or Ethernet. The CII interface can be PLC, or RF interface, or RS-485 interface. CII interface can be GPRS/3G/4G, or Ethernet.
- 4) Meter: Electricity meter. It has MI0 interface for local maintenance, MI1 interface to DCU, MI2 interface to HES. MI0 interface is optical port. MI1 interface is PLC or RF port or RS-485. MI2 interface is GPRS/3G/4G, or NB-IoT/CAT-M, or Ethernet port. The meter normally only equips with one physical MI1 to DCU, or MI2 interface to HES.
- 5) Operation and maintenance device: It is a local maintenance device for accessing and operating meter and DCU. In general, it is a Hand-Held Unit.
- 6) DS: Deployment System.

### 4.1 Interfaces Specifications of Electricity Meter

#### 4.1.1 Optical Interface (MI0)

The MI0 interface is based on IEC 62056-46 direct HDLC profile. The baud rate shall be at least 9600 bps. All read-out procedures need to be compliant to DLMS / COSEM. It is used for local communication.

#### 4.1.2 LAN– DCU Interface(MI1)

The MI1 interface is used to communicate with DCU, it can be:

- 1) G3-PLC interface, with TCP-IP profile
- 2) RF interface, LoRa with HDLC profile, Wi-SUN with TCP-IP profile
- 3) RS-485, with IEC 62056-46 direct HDLC profile

#### 4.1.3 WAN– HES Interface(MI2)

The MI2 interface is used to directly communicate with HES. Normally, it is cellular communication, i.e. GPRS/3G/4G/NB-IoT/CAT-M. The MI2 interface is based on the DLMS/COSEM TCP/IP profile.

#### 4.1.4 Parallel Association

Each communication interface of meter shall support the separate association at the same time. Communication on one interface shall not impact the communication on other interfaces.

## 4.2 Client/Server Architecture

The meter acts as a DLMS sever. It supports 5 association clients:

- 1) **Public client.** According to DLMS/COSEM specification, the Public client is used to read the meter's general information (e.g. logical device name, invocation counter) to reveal the structure of the meter. It is not allowed to read metering data and set the meter parameters. It has lowest level security (no security).
- 2) **Readout client.** The Read client is used to read the data and parameters from the meters. It can't set the meter parameters, and can't control the meter.
- 3) **Maintenance client.** Except to read the data and parameters as that of Read client, the Maintenance client is allowed to set the parameters and control the objects in the meters and execute the firmware upgrade.
- 4) **Management client.** The management client has the highest access security, it supports to read meter, set parameters, control the meter, execute the firmware upgrade.
- 5) **Pre-established client.** The client is mainly used for event push.

The following table describes the features of each client.

Client Name	SAP	Service	Security level	Release
Public client	016	<ul style="list-style-type: none"> <li>• Block-transfer-with-get</li> <li>• Get</li> <li>• Selective Access</li> </ul>	<ul style="list-style-type: none"> <li>• Lowest Level Security</li> </ul>	<ul style="list-style-type: none"> <li>• RLRQ service</li> <li>• Closing or losing transport layer connection</li> <li>• A power-down will automatically close the association</li> </ul>
Readout client	002	<ul style="list-style-type: none"> <li>• Block-transfer-with-get</li> <li>• Get</li> <li>• Get-with-list</li> <li>• Selective Access</li> <li>• Action</li> </ul>	<ul style="list-style-type: none"> <li>• HLS 5 GMAC</li> <li>• Security suite 0</li> </ul>	
Maintenance client	006	<ul style="list-style-type: none"> <li>• Block-transfer-with-get</li> <li>• Block-transfer-with-set</li> <li>• Get</li> <li>• Multiple reference</li> <li>• Set</li> <li>• Selective Access</li> <li>• Action</li> <li>• General-protection</li> </ul>	<ul style="list-style-type: none"> <li>• HLS 5 GMAC</li> <li>• Security suite 0</li> </ul>	
Management client	001	<ul style="list-style-type: none"> <li>• Block-transfer-with-get</li> <li>• Block-transfer-with-set</li> <li>• Get</li> <li>• Set</li> <li>• Multiple reference elective Access</li> <li>• Action</li> <li>• General-protection</li> </ul>	<ul style="list-style-type: none"> <li>• HLS 5 GMAC</li> <li>• Security suite 0</li> </ul>	
Pre-established client	102	<ul style="list-style-type: none"> <li>• Block-transfer-with-get</li> <li>• Block-transfer-with-set</li> <li>• Get</li> <li>• Set</li> <li>• Multiple reference</li> <li>• Selective Access</li> <li>• Action</li> <li>• Event notification</li> <li>• General-protection</li> </ul>	<ul style="list-style-type: none"> <li>• Pre-established</li> </ul>	

## 5 DLMS/COSEM Application Layer

### 5.1 APDU Size

For the MI2 (WAN-HES) interface, the APDU size of receiving and transmission shall be at least 256 bytes and negotiable. This means no segmentation from negotiated size of message shall occur in application layer. If a message is negotiated with size of 1024 bytes, it should be transferred only with size of 1024 byte.

### 5.2 Security Features

#### 5.2.1 Security Algorithm

The meter uses DLMS security suite 0. The following objects are required for the management of security:

Object / Attribute Name	Class	Ver.	OBIS code
Association LN - Current Client Association	15	3	0-0:40.0.0.255
Association LN - Public Client	15	3	0-0:40.0.1.255
Association LN - Readout Client	15	3	0-0:40.0.2.255
Association LN - Management Client	15	3	0-0:40.0.3.255
Association LN - Maintenance Client	15	3	0-0:40.0.5.255
Association LN - Pre-established Client	15	3	0-0:40.0.6.255
Current Security setups	64	1	0-0:43.0.0.255
Security setup - Readout Client	64	1	0-0:43.0.2.255
Security setup - Management Client	64	1	0-0:43.0.3.255
Security setup - Maintenance Client	64	1	0-0:43.0.5.255
Security setup - Pre-established Client	64	1	0-0:43.0.6.255

Table:  
security  
objects

#### Association LN - Current Client Association

This object contains the information of the current association.

#### Association LN - Public Client/ Read Client/ Maintenance Client/ Management Client/ Pre-established Client

The Association LN objects support the association management of the individual client. The most important information in the association is the object list, through which the client is able to download the whole set of the object model supported by the meter including the access right of each attribute and method.

#### Security Setup

The management client is the highest authority within the DLMS server.

For the other clients, individual security setup objects exist that allow the management client to change the settings and keys for these clients.

The keys except dedicated key can be changed via the “key\_transfer” method of “Security Setup”.

#### 5.2.2 Security policy

The security policy can be combination of the following options (“Security setup” version 1):

- Bit0 - unused
- Bit1 –unused
- Bit2 - authenticated request
- Bit3 - encrypted request
- Bit4 –unused
- Bit5 - authenticated response
- Bit6 - encrypted response
- Bit7 - unused

### 5.2.3 Usage of Keys

Depending on the security policy set and the individual access right definition of the attributes and methods, the following keys will be used according to their security context:

- 1) Global unicast encryption key (EK)
- 2) Global authentication key (AK)
- 3) Global broadcast encryption key (BK)
- 4) Master key (KEK)
- 5) Dedicated Key

The meters must accept a single AA established with or without a dedicated key.

When the keys are changed, the AES key wrap algorithm is used. This algorithm is using the master key to encrypt the key that is being changed.

The lifetime of the Global Keys of each security context is limited by the range of the associated Invocation Counters. A global key may be a unicast encryption key (EK), a broadcast encryption key (BK) or an authentication key (AK);

Dedicated keys are valid during the lifetime of an association, i.e. the dedicated key is generated and taken in use with the opening of the association. The key is destroyed automatically by the server upon closing of the association.

### 5.2.4 Invocation Counter (IC)

For managing the corresponding frame counters, the following objects are required:

Object / Attribute Name	Class	Ver.	OBIS code
Rx frame counter - unicast key - Management Client	1	0	0-0:43.1.0.255
Rx frame counter - unicast key - Readout Client	1	0	0-0:43.1.2.255
Rx frame counter - unicast key - Maintenance Client	1	0	0-0:43.1.4.255

The actual IC value:

Data type: double-long-unsigned

The maximum values: 0xFFFFFFFF

Depending on the security policy set and the individual access right defined for the attributes and methods, the Global unicast Encryption Key (EK) or Global Authentication Key(AK) is used. When the EK is used per security context, the corresponding IC is incremented by 1 and stored in the non-volatile memory. The message will be discarded if the IC in the received message is smaller or equal to the IC in the previously received message.

- A new EK is changed, the corresponding IC are reset to 0.
- When the maximum value of the IC has been reached, any following invocation of the authenticated encryption function shall return an error and the IC shall not be incremented.
- Frame Counters used with dedicated keys are independent of the ICs used with global keys.
- ICs used with dedicated keys are reset to 0 when a new association is established .

## 6 LTE -WAN Interface

The DLMS TCP-UDP/IP based profile is used for the LTE WAN interface. It includes the protocol layers as follows:

- COSEM Application Layer;
- COSEM TCP-UDP Wrapper Layer;
- TCP/UDP Transport Layer;
- Internet Protocol (IPv4/IPv6) Network Layer;
- IPv4/IPv6 Supporting Data Link Layer;
- Physical Layer;

COSEM application layer (and COSEM Clients/Logical Device) uses the services of TCP or UDP Transport layers via COSEM Wrapper sub-layer. The Transport layer (TCP or UDP) and COSEM wrapper together is called COSEM Transport layer. The meter shall support both TCP and UDP transport layer.

The following objects are supported:

Capture Objects	Class	Ver.	OBIS code
Module chip version	1	0	0-1:94.31.0.255
Module IMEI	1	0	0-1:94.31.2.255
SIM card IMSI	1	0	0-1:94.31.3.255
SIM card ICCID	1	0	0-1:94.31.4.255
Module RSRP	1	0	0-1:94.31.7.255
Module RSRQ	1	0	0-1:94.31.8.255
Module RSSI	1	0	0-1:94.31.9.255
Module SNR	1	0	0-1:94.31.10.255
Module PCI	1	0	0-1:94.31.11.255
Module FOTA HTTP URL	1	0	0-1:94.31.22.255
Module FOTA upgrade status	1	0	0-1:94.31.24.255
Module FOTA script enable	9	0	0-2:10.0.1.255
Auto Connect	29	2	0-0:2.1.0.255
TCP-UDP Setup	41	0	0-0:25.0.0.255
IPv4 Setup	42	0	0-0:25.1.0.255
PPP setup	44	1	0-0:25.3.0.255
Modem setup	45	0	0-0:25.4.0.255
IPv6 Setup	48	0	0-0:25.7.0.255

Table: Communication objects

### 6.1 Basic information

#### Module chip version

The LTE module chipset firmware version.

#### Module IMEI

International Mobile Equipment Identity.

#### SIM card IMSI

International Mobile Subscriber Identity.

#### SIM card ICCID

Integrate Circuit Card Identity.

### **Module RSRP**

Reference Signal Receiving Power

RSRP is a key parameter representing the wireless signal strength, reflecting the path loss strength of the current channel, which is used for cell coverage measurement and cell selection / reselection.

RSRP value range: -44 ~ -156dbm, the larger the value, the better.

### **Module RSRQ**

Reference Signal Received Quality.

RSRQ refers to the signal-to-noise ratio and interference level of the current channel quality. It is not only related to the re power of RS, but also related to the re power of user data, and the interference of adjacent areas. Therefore, RSRQ changes with the network load and interference. The larger the network load, the greater the interference, and the smaller the RSRQ measurement value.

The value range of RSRQ is: -3 ~ -19.5, the larger the value is, the better.

### **Module RSSI**

Received Signal Strength Indicator

### **Module SNR**

Signal Noise Ratio

The ratio of signal power to noise power, the greater the ratio, the better.

### **Module PCI**

The physical cell ID of the service cell, range: 0-503.

### **Module FOTA HTTP URL**

Module firmware upgrade HTTP server address, used to module download the firmware upgrade packet.

### **Module FOTA upgrade status**

Module firmware upgrade status, indicate the schedule for upgrade.

### **Module FOTA script enable**

Module upgrade script, used to trigger the download and upgrade process.

## **6.2 Network Connecting Mechanisms**

### **Auto Connect**

The LTEs communication module should be always online. Meters shall support mode 101 and 105.

Mode 101 is Always-On mode. In this mode, meter will work as server and wait for remote connection.

Mode 105 is connected mode. In this mode, meter will auto connect HES for first connection and keep alive the TCP connection.

## **6.3 Communication Configuration Information**

To establish communication and exchange data between parties (COSEM Client and Server), all layers shall be configured. In this section, the parameters to configure each layer are presented.

### **TCP-UDP Setup (Transport Layer Configuration)**

The following parameters are considered in TCP-UDP Setup objects to configure transport layer:

- TCP-UDP Port Number: to distinguish between different Applications in each physical device (COSEM client or server), an additional addressing is provided inside the device at transport layer. Both TCP and UDP handle this

addressing capability at the Transport layer. This is called Port. Each Application in physical device has its own TCP-UDP port number. The 4059 port numbers have been considered for DLMS/COSEM.

- Related IP Setup Object: As mentioned, an instance of TCP-UDP and IPv4/IPv6 Setup objects shall be considered for each data link layer is supported by physical device.  
The IP reference is 0.0.25.1.0.255 means use IPv4 setup(default).  
The IP reference is 0.0.25.7.0.255 means use IPv6 setup.
- Maximum Segment Size: the default value is 1280.
- Maximum Number of Simultaneous Connections: This parameter specifies the maximum number of simultaneous connection supported by COSEM TCP-UDP based transport layer.
- TCP Timeout: This parameter defines the time (in seconds) over which, if no frame is received from the COSEM client, the TCP connection shall be aborted. The default value is "300" seconds.

The "0" value means a TCP connection, once established, will never be aborted by the COSEM server in normal condition (no power failure and so on). This parameter can be changed by HES during operation.

#### **IPv4 Setup (Network Layer Configuration)**

The object is considered to configure the network layer and get the ipv4 address.

#### **PPP Setup (Data Link Layer Configuration)**

The object is considered to configure the network authentication, PAP authentication, CHAP authentication or no authentication(default), and store the username and password for PAP or CHAP.

#### **LTE Modem Setup (Physical Layer Configuration)**

The following parameters are included in this COSEM object:

- APN;
- PIN Code;
- Quality of Service;

The initial values of these parameters should be set before first installation.

#### **IPv6 Setup (Network Layer Configuration)**

The object is considered to configure the network layer and get the ipv6 address.

## **7 G3-PLC LAN Interface**

The DLMS/COSEM communication via the LAN interface is based on UDP over the IPV6 stack in combination with the G3-PLC transport layer.

### **7.1 UDP Transport Layer Settings**

This section focuses on the use of the UDP protocol within the G3-PLC metering profile.

### **7.2 UDP Port Numbering**

The DLMS/COSEM application has an interface with UDP transport layer. In the G3-PLC metering profile the UDP ports for the DLMS/COSEM application layer shall be chosen between 61616 and 61631 to benefit from the best compression of 6LoWPAN adaptation layer.

### **7.3 UDP Header Compression**

UDP header compression shall be conformant with G3-PLC Specification.

### **7.4 ICMPv6 Requirements**

The implementation of ICMPv6 is mandatory for all G3-PLC devices for ping functionality use.

In current scope, “Echo Request Message” and “Echo Reply Message” is mandatory to be implement while others are optional. An “Echo Reply” should be sent in response to an Echo Request message sent to an IPv6 unicast address and not to a multicast address.

## 7.5 Bootstrapping and Keep-Alive

A standard PAN-Device’s bootstrapping shall start from a discovery procedure. After the discovery procedure, the PAN descriptor list is available. First of all, the PAN chosen shall give preference to the one which have succeed joining and application communication in last bootstrapping. If it is not available, choose the one among the neighbours providing the best link quality (LQI) with the local node. Once the PAN is identified, the LBA chosen is the node providing the lowest route cost toward the PAN-selected coordinator, including the link cost toward the LBA chosen. The route cost computation is similar to a standard route discovery. Based on all beacons received during the active scan, the node computes the link cost toward each possible LBA according to the metric in use, and adds it to the RC\_COORD received in the beacon. The node shall set the Weak Link Count to 1 in case the LQI of the link to the LBA is below adp Weak LQI Value. Similar to the G3-PLC protocol, the best route is defined by the lowest route cost among the lowest number of Weak Link computed. This way, the node is able to select the LBA providing the best route toward the coordinator. Note that LBA is not selected if its LQI with the local node is below Join LQI Threshold.

The following algorithm shall be applied for a device to join a PAN:

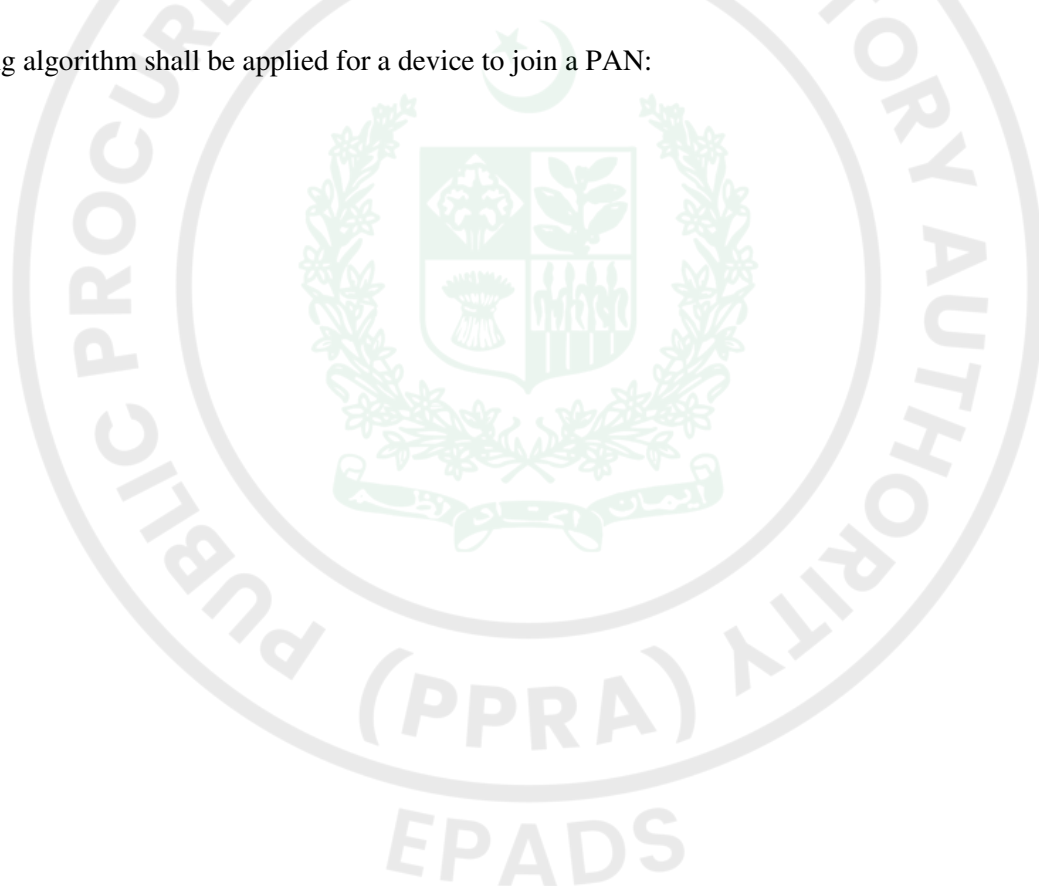

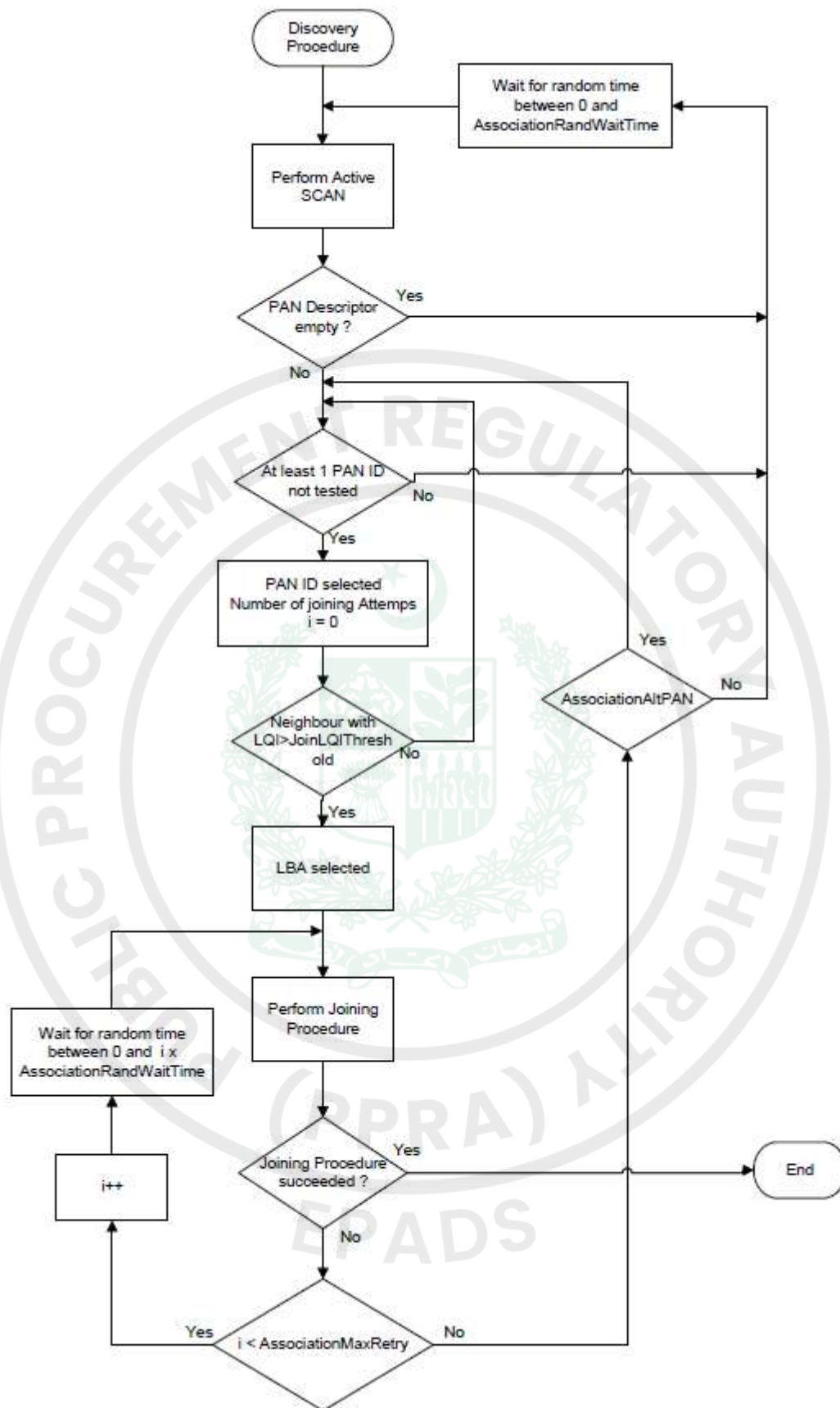

A route discovery process shall be performed immediately after joining procedure succeeded.

The ID-P used in bootstrapping process shall be set as electrical meter's DLMS/COSEM logical device name.

When a device is operating within a PAN, a keep alive mechanism shall be supported in order to maintain the device's association with the aforementioned PAN.

Each G3-PLC PAN-device shall implement a timer with a PLC Time Out period. When this timer expired, PAN-Device shall generate ADPM-NETWORK-LEAVE .request to return to non-association state and perform bootstrapping immediately.

These messages:

- Path Request (6loWPAN level),
  - ICMP Echo Request, ICMP Echo Reply (IP level),
  - OPEN request, RELEASE request, GET request, SET request, ACTION request etc. (COSEM level),
- when sent in unicast by the PAN coordinator shall reset the PLCG3TimeOut timer.

Before the device’s G3-PLC timeout expires, precisely after a duration indicated by Keep Alive Start Time, PAN-Device also could sends periodic ICMP Echo requests intended for the PAN coordinator at a rate provided by the Keep Alive Send Period parameter. This mechanism may be disabled in setting the Keep Alive Enable parameter to FALSE.

## 7.6 UDP/IP Profile

The DLMS COSEM application connects to the TCP/IP or UDP/IP layer using and additional sublayer called the DLMS/COSEM wrapper. The G3-PLC module must support the DLMS/COSEM wrapper’s payload up to 1224 bytes.

The UDP/IP channel is configured and managed via the following COSEM objects:

Object / Attribute Name	Class	Ver	OBIS code
TCP-UDP setup	41	0	0-0:25.0.0.255
IPv6 setup	48	0	0-0:25.7.0.255

The UDP client port number used by the “COSEM Client Application Layer” should be set between 61617 (0xF0B1) and 61631 (0xF0BF) as recommendation.

The UDP server port number used by the “COSEM Server Application Layer” shall be set 61616 (0xF0B0) by default.

The following table summarizes the recommended UDP port numbers for the DLMS/COSEM metering application:

Application	Server UDP ports		Client UDP ports	
	Ports applying for packets emitted by the server to the client		Ports applying for packets emitted by the client to the server	
	Source	Destination	Source	Destination
DLMS/COSEM Pull Service	61616	61616~61629	61617~61629	61616
DLMS/COSEM Push Service	61616	61631	N/A	N/A

*Note: the destination port must be 61631 when DLMS/COSEM service used.*

EPADS

## 7.7 G3-PLC Network Management

The G3 channel is configured and managed via the following COSEM objects:

Object / Attribute Name	Class	Ver	OBIS code
MAC Address Setup	43	0	0-0:25.2.0.255
G3-PLC 6LoWPAN adaptation layer setup	92	2	0-0:29.2.0.255
G3-PLC MAC setup	91	2	0-0:29.1.0.255
G3-PLC MAC layer counters	90	1	0-0:29.0.0.255
G3-PLC Band Plan	1	0	0-0:94.43.128.255
G3-PLC PSK_KEK	1	0	0-0:94.43.133.255
G3-PLC PSK	1	0	0-0:94.33.128.255
G3-PLC Timeout	1	0	0-0:94.33.10.255
G3-PLC Keep Alive	1	0	0-0:94.33.11.255
G3-PLC Mac Coherent Transmission	1	0	0-0:94.33.12.255
G3-PLC Mac Device Table	1	0	0-0:94.33.13.255
G3-PLC Adp LBP Association Setup	1	0	0-0:94.33.14.255
G3-PLC RREP Wait	1	0	0-0:94.33.15.255
G3-PLC LQI Range	1	0	0-0:94.33.16.255

### MAC Address Setup

The MAC address setup holds the EUI-64 address of the G3-PLC Modem.

### G3-PLC 6LoWPAN adaptation layer setup

This object holds the necessary parameters to set up the 6LoWPAN adaptation sub-layer and provides access to information settings and tables that might be necessary for the network management. Refer to DLMS Blue Book Edition 14.

### G3-PLC MAC setup

This object holds the necessary parameters to set up the MAC IEEE 802.15.4 sub-layer and provides access to information settings and tables that might be necessary for the network management. Refer to DLMS Blue Book Edition 14.

### G3-PLC MAC layer counters

This object stores the counters relating to exchanges between PHY and MAC. The purpose of these counters is to provide statistical information for maintenance.

Note: when a counter reaches its maximum value (0xFFFFFFFF), it is automatically reset.

### G3-PLC Band Plan

This object allows the identification of the current band plan in use.

The supported band plans are

0 = CENELEC-A band

3 = FCC band

If band switch is available through this object, once the configuration change, the module returns to the non-associated state and re-starts its joining process for the reconnection to the PAN coordinator.

### G3-PLC PSK\_KEK

This object allows changing the PSK Key Encryption Key (128 bits / 16 octets) of the meter.

The new PSK\_KEK is wrapped by the AES-128 key wrap algorithm, using the current PSK\_KEK as the wrapping key.

### **G3-PLC PSK**

This object allows changing the PSK (128 bits / 16 octets) of the G3-PLC module.

The new PSK is wrapped by the AES-128 key wrap algorithm, using the dedicated PSK KEK as the wrapping key. After the successful change of the PSK (confirmation to the DLMS client), the meter returns to the non-associated state and re-starts its joining process for the reconnection to the PAN coordinator.

### **G3-PLC Timeout**

This data defines the time, in minutes, after which a meter that has not been individually addressed (meaning the meter has not received any Path Discovery message, ICMP ping, nor unicast DLMS APDU) returns to the non-associated state and loses its PAN coordinator. A value equal to 0 is equivalent to cancel the use of the related time-out-not-addressed counter.

### **G3-PLC Keep Alive**

This object defines the parameters used by the “keep alive” mechanism.

KeepAlive ::= structure

```
{
keep_alive_enable: boolean
keep_alive_start_time: long-unsigned
keep_alive_send_period: unsigned
}
```

### **G3-PLC Mac Coherent Transmission**

This object indicates the specific modulation scheme to set in the tone map response.

0 = only differential modulation scheme shall be set in tone map response

1 = only coherent modulations scheme shall be set in tone map response

2 = Either coherent or differential scheme may be set in tone map response.

### **G3-PLC Mac Device Table**

This object describes a table of Device-Descriptor entries.

array Device Descriptor Entry

Device DescriptorEntry ::= structure

```
{
Pan_id: long-unsigned
Short_address: long-unsigned
Frame_counter: double-long-unsigned
}
```

### **G3-PLC Adp LBP Association Setup**

This attributes contains parameters for Bootstrapping procedure setup.

Adp LBP Association Setup ::= structure

```
{
Association Max Retry: unsigned
Association Rand Wait Time :unsigned
Association AlterPAN: boolean
Join LQI Threshold: unsigned
Active ScanDuration: unsigned
}
```

### G3-PLC RREP Wait

This object defines the delay for an RREP frame to wait in seconds before being generated after either the arrival of the first RREQ or the transmission of the latest RREP.

### G3-PLC LQI Range

The LQI range defines the lower and higher LQI value used for the metric computation.

LQI Range ::= structure

```
{
    adp_low_lqi_value:    unsigned
    adp_high_lqi_value:   unsigned
}
```

## 8 Device Identification

According to the DLMS/COSEM requirements and to provide the interoperability in whole system, each physical device in system shall be uniquely identified. Each physical device is identified by following designations in system:

- The System Title will be assigned to each physical device during manufacturing stage and based on manufacturer FLAG code, device type and product serial number. It is used as physical device unique ID in all communications in system.
- The Logical Device Name is another format of the system title. The Logical Device Name will be stored in “COSEM Logical Device Name” COSEM object (0-0:42.0.0.255) during manufacturing stage.
- Utility Device ID is the unique device ID designated by utility and stored in the meter during the manufacturing stage. A related barcode will be presented in the meter nameplate.

### 8.1 System Title

Each physical device (meter) shall be uniquely identified by its “System Title”. The “System Title” shall be constructed as follows according to DLMS/COSEM definition:

Byte 1	Byte 2	Byte 3	Byte 4	Byte 5	Byte 6	Byte 7	Byte 8
MFG_ID			DT	FT	MSN		

**MFG\_ID:** Manufacturer ID (three letters flag) defined by DLMS UA, as ASCII (bytes 1, 2, 3).

**DT** (Device Type):

100	1P Meter
101	3P Direct connection meter
093	3P CT connection meter
097	3P CT/PT connection meter

**FT**(Function Type, 4 bits) Function type shows whether device supports disconnecter, load management and multi-utility meter or not. Function Type(FT) for HES and DCU/Gateway is 0. The bits arrangement is as follow:

- bit0: Disconnecter exists or not
- bit1: Load Management exists or not
- bit2: Multi-utility meter is supported or not
- bit3: reserved for future use

Example:

Function Type for a meter with disconnecter, load management features, without Multi-utility function will be 0011.

**MSN:** Manufacturer specific serial number (the next 28 bits, half of byte5 and bytes 6, 7, 8);

**Note:** These 28 bits can be derived from the last seven digits of the manufacturing serial number, up to 9 999 999 (equal to 0x98967F).

## 8.2 COSEM Logical Device Name

Each COSEM logical device can be identified by its unique **COSEM logical device name** (0-0:42.0.0.255). The logical device name is defined as an octet-string of up to 16 octets (bytes). The first three octets shall carry the manufacturer identifier (administered by the DLMS User Association). The logical device name structure is shown in the following figure.

Byte 1	Byte 2	Byte 3	Byte 4	Byte 5	Byte 6	Byte 7	Byte 8
MFG_ID			DT			FT	
Byte 9	Byte 10	Byte 11	Byte 12	Byte 13	Byte 14	Byte 15	Byte 16
MSN							

**MFG\_ID:** Manufacturer ID (three letters flag) defined by DLMS UA, as ASCII (bytes 1, 2, 3).

**DT:** Device Type defined in System Title, as ASCII

**FT:** Function Type defined in System Title, as ASCII

**MSN:** The last 8 digits of the manufacturer specific serial number, as ASCII

## 8.3 Utility Device ID

The Utility Device ID (and corresponding barcode according to Code 128 Barcode) shall be printed on meter body. The Utility Device ID is defined by utility per project.

The different identifiers of each device are presented as device ID. Each device ID is stored in a dedicated COSEM object from interface class. The device IDs that have been used are as following table:

Object / Attribute Name	Class	Ver.	OBIS code
Device ID 1: Serial number	1	0	0-0:96.1.0.255

Table: Device IDs

## 9 Energy Registers

The meter stores the corresponding energy or demand registers.

### 9.1 Total Energy Registers

The energy consumption will be accumulated in below registers:

Object / Attribute Name	Class	Ver.	OBIS code
Active energy import (+A)	3	0	1-0:1.8.0.255
Active energy export (-A)	3	0	1-0:2.8.0.255
Reactive energy import (+R)	3	0	1-0:3.8.0.255
Reactive energy export (-R)	3	0	1-0:4.8.0.255
Reactive energy for quadrant 1	3	0	1-0:5.8.0.255
Reactive energy for quadrant 2	3	0	1-0:6.8.0.255
Reactive energy for quadrant 3	3	0	1-0:7.8.0.255
Reactive energy for quadrant 4	3	0	1-0:8.8.0.255

Table: Total energy

For single-phase meter, the detection of neutral line current shall be supported. When the current of neutral line is greater than the current of phase line, which means that tamper probably have occurred at this time. In order to reduce the measurement loss, the meter shall use the current of the neutral line to accumulate energy.

## 9.2 TOU Energy Registers

The related tariff energy registers should be supported:

Object / Attribute Name	Class	Ver.	OBIS code
Active energy import (+A) tariff x	3	0	1-0:1.8.x.255
Active energy export (-A) tariff x	3	0	1-0:2.8.x.255
Reactive energy import (+R) tariff x	3	0	1-0:3.8.x.255
Reactive energy export (-R) tariff x	3	0	1-0:4.8.x.255

Table: TOU energy registers

**Note:** x = 1~4, for tariff 1~4

## 10 Demand Registers

### 10.1 Demand Registers

The “Demand register” objects measure average value of power during a period. The following demand registers should be supported:

Object / Attribute Name	Class	Ver.	OBIS code
Demand active import (+P)	5	0	1-0:1.4.0.255
Demand active export (-P)	5	0	1-0:2.4.0.255
Demand reactive import (+Q)	5	0	1-0:3.4.0.255
Demand reactive export (-Q)	5	0	1-0:4.4.0.255
Maximum demand active import (+P)	4	0	1-0:1.6.0.255
Maximum demand active export (-P)	4	0	1-0:2.6.0.255
Maximum demand reactive import (+Q)	4	0	1-0:3.6.0.255
Maximum demand reactive export (-Q)	4	0	1-0:4.6.0.255

Table: Demand Registers

The Maximum Demand Registers are reset when the meter executes billing.

### 10.2 TOU Demand Registers

Related tariff demand objects should be supported as below:

Object / Attribute Name	Class	Ver.	OBIS code
Maximum demand active import (+P) tariff x	4	0	1-0:1.6.x.255
Maximum demand active export (-P) tariff x	4	0	1-0:2.6.x.255
Maximum demand reactive import (+Q) tariff x	4	0	1-0:3.6.x.255
Maximum demand reactive export (-Q) tariff x	4	0	1-0:4.6.x.255

Table: Demand Registers

**Note:** x = 1~4, for tariff 1~4

## 10.3 Cumulative Maximum Demand Registers

The cumulative maximum demand stores the sums of the corresponding maximum demand register value in all completed billing periods since the beginning of the measurement.

Object / Attribute Name	Class	Ver.	OBIS code
Cumulative Maximum demand active import (+P)	3	0	1-0:1.2.0.255
Cumulative Maximum demand active export (-P)	3	0	1-0:2.2.0.255
Cumulative Maximum demand reactive import (+Q)	3	0	1-0:3.2.0.255
Cumulative Maximum demand reactive export (-Q)	3	0	1-0:4.2.0.255
Cumulative Maximum demand active import (+P) tariff x	3	0	1-0:1.2.x.255
Cumulative Maximum demand active export (-P) tariff x	3	0	1-0:2.2.x.255
Cumulative Maximum demand reactive import (+Q) tariff x	3	0	1-0:3.2.x.255
Cumulative Maximum demand reactive export (-Q) tariff x	3	0	1-0:4.2.x.255

Note: x = 1~4, for tariff 1~4

## 11 Power Quality

### 11.1 Instantaneous Parameters

The meter supports the following instantaneous parameters. These parameters are updated every second.

No.	Default Capture Objects
1	Time stamp
2	Power quality load profile status
3	Average voltage L1
4	Maximum voltage L1
5	Minimum voltage L1
6	Average current L1
7	Average value of power factor

Table: Instantaneous Parameter

### 11.2 Export energy function

The meter support “Export Energy” measurement and relevant functions for solar power and generator application, this function can be switched ON or switched OFF by command from system remotely or configure locally. “Export Energy” function is switched OFF as default.

When the reverse current is detected, the current reverse event will be logged.

When the “Export Energy” function is switched OFF, if current reverse condition occurs, the reverse current and duration time over a certain threshold which can be configured, an additional action will be performed:

- Disconnect the relay
- Event “Local disconnection due to current reverse” will be logged
- The bit 5 “Current reverse” will be set in the Tamper status word
- The LCD displays “OFF-REV”

The meter relay will reconnect when current reverse condition removed and a tamper reset command send from the HES or hand-held device. Or

The “Export Energy” is switched ON remotely or locally, the tamper will be reset automatically and the relay will be reconnected.

Export energy function is supported by the following objects:

Object / Attribute Name	Class	Ver.	OBIS code
Threshold for current reverse	3	0	1-0:11.35.3.255
Time threshold for current reverse	3	0	1-0:11.44.0.255
Export energy function enable	1	0	1-0:96.0.160.255

## 12 Calendar and Tariff Management

Object / Attribute Name	Class	Ver.	OBIS code
Activity calendar	20	0	0-0:13.0.0.255
Current active tariff	1	0	0-0:96.14.0.255
Special days table	11	0	0-0:11.0.0.255
Tariffication script table	9	0	0-0:10.0.100.255
Register activation – Energy	6	0	0-0:14.0.1.255
Register activation – Maximum Demand	6	0	0-0:14.0.2.255

### Activity calendar

The activity calendar must support at least:

- season\_profile => at least 4 seasons
- week\_profile\_table => at least 4 entries
- day\_profile\_table => at least 4 entries
- day\_profile => up to 24 switching times per day

### Special days table

Special days table must support up to 50 entries.

### Tariffication script table

The tariffication script table supports up to 4 switching scripts.

Script identifier	Action
1	Tariff 1 are activated
2	Tariff 2 are activated
3	Tariff 3 are activated
4	Tariff 4 are activated

### Current active tariff

This object is used for reading the current tariff in use.

**Note:** when time is invalid, the meter will use the default tariff T1.

## 13 Clock Synchronization

The following objects support this functionality:

Object / Attribute Name	Class	Ver.	OBIS code
Clock	8	0	0-0:1.0.0.255
Local Time	1	0	1-0:0.9.1.255
Local Date	1	0	1-0:0.9.2.255

Table: clock objects

### Clock

The standard time zone has 300 minutes deviation from the UTC time.

#### Clock status:

Bit #	Status
0	invalid value
1	doubtful value
2	Reserved
3	invalid clock status
4	Reserved
5	Reserved
6	Reserved
7	daylight saving active

#### Synchronization Scheme with DCU

The meter shall support broadcast clock synchronization via the DCU, the broadcast synchronization features the following condition:

- 1) The meter is only allowed to receive 3 broadcast clock synchronization within one day.
- 2) The meter only accepts clock synchronization with a clock deviation within 10s to 10min, when clock deviation is less than 10s, the meter will reject the synchronization; when clock deviation is greater than 10 minutes, the meter will also reject the synchronization, and log and push the event “Clock Out Of Tolerance” to the HES. In the case, the HES needs to synchronize the meter clock point-to-point.
- 3) If meter clock is already invalid, the clock synchronization with any time deviation will be accepted by the meter.

## 14 Billing

The meter records some specific values for billing purpose. The following objects support this functionality:

Object / Attribute Name	Class	Ver.	OBIS code
Monthly Billing Profile	7	1	0-0:98.1.0.255
Billing period counter	1	0	0-0:0.1.0.255
End of billing period / MDI reset	22	0	0-0:15.0.0.255
End of billing period script table	9	0	0-0:10.0.1.255

Table: billing objects

## 14.1 Monthly Billing Data

### Billing Profile

Billing capacity: 13 entries. (13 months).

Billing objects: The billing objects are in the following table.

Buffer encoding/reading: normal, clock with every entry.

Selective access: by range and by entry.

Sorted method: unsorted (FIFO).

The default capture objects of monthly billing:

Billing Objects	OBIS Code
Time stamp	0.0.1.0.0.255
Billing period counter	0.0.0.1.0.255
Active energy total ( +A + -A )	1.0.15.8.0.255
Active energy total ( +A + -A ) T1	1.0.15.8.1.255
Active energy total ( +A + -A ) T2	1.0.15.8.2.255
Active energy total ( +A + -A ) T3	1.0.15.8.3.255
Active energy total ( +A + -A ) T4	1.0.15.8.4.255
Active energy import (+A)	1.0.1.8.0.255
Active energy import (+A) T1	1.0.1.8.1.255
Active energy import (+A) T2	1.0.1.8.2.255
Active energy import (+A) T3	1.0.1.8.3.255
Active energy import (+A) T4	1.0.1.8.4.255
Active energy export (-A)	1.0.2.8.0.255
Active energy export (-A) T1	1.0.2.8.1.255
Active energy export (-A) T2	1.0.2.8.2.255
Active energy export (-A) T3	1.0.2.8.3.255
Active energy export (-A) T4	1.0.2.8.4.255
Reactive energy total ( +R + -R )	1.0.128.8.0.255
Reactive energy total ( +R + -R ) T1	1.0.128.8.1.255
Reactive energy total ( +R + -R ) T2	1.0.128.8.2.255
Reactive energy total ( +R + -R ) T3	1.0.128.8.3.255
Reactive energy total ( +R + -R ) T4	1.0.128.8.4.255
Reactive energy import(+R)	1.0.3.8.0.255
Reactive energy import(+R) T1	1.0.3.8.1.255
Reactive energy import(+R) T2	1.0.3.8.2.255
Reactive energy import(+R) T3	1.0.3.8.3.255
Reactive energy import(+R) T4	1.0.3.8.4.255
Reactive energy export (-R)	1.0.4.8.0.255
Reactive energy export (-R) T1	1.0.4.8.1.255
Reactive energy export (-R) T2	1.0.4.8.2.255
Reactive energy export (-R) T3	1.0.4.8.3.255
Reactive energy export (-R) T4	1.0.4.8.4.255
Maximum Demand Active total ( +P + -P )	1.0.15.6.0.255
Maximum Demand Active total ( +P + -P )-Capture Time	1.0.15.6.0.255
Maximum Demand Active total ( +P + -P ) T1	1.0.15.6.1.255
Maximum Demand Active total ( +P + -P )-Capture Time T1	1.0.15.6.1.255
Maximum Demand Active total ( +P + -P ) T2	1.0.15.6.2.255

Maximum Demand Active total ( +P + -P )-Capture Time T2	1.0.15.6.2.255
Maximum Demand Active total ( +P + -P ) T3	1.0.15.6.3.255
Maximum Demand Active total ( +P + -P )-Capture Time T3	1.0.15.6.3.255
Maximum Demand Active total ( +P + -P ) T4	1.0.15.6.4.255
Maximum Demand Active total ( +P + -P )-Capture Time T4	1.0.15.6.4.255
Maximum Demand Active import (+P)	1.0.1.6.0.255
Maximum Demand Active import (+P) capture time	1.0.1.6.0.255
Maximum Demand Active import (+P) T1	1.0.1.6.1.255
Maximum Demand Active import (+P) T1 capture time	1.0.1.6.1.255
Maximum Demand Active import (+P) T2	1.0.1.6.2.255
Maximum Demand Active import (+P) T2 capture time	1.0.1.6.2.255
Maximum Demand Active import (+P) T3	1.0.1.6.3.255
Maximum Demand Active import (+P) T3 capture time	1.0.1.6.3.255
Maximum Demand Active import (+P) T4	1.0.1.6.4.255
Maximum Demand Active import (+P) T4 capture time	1.0.1.6.4.255
Maximum Demand Active export (-P)	1.0.2.6.0.255
Maximum Demand Active export (-P) capture time	1.0.2.6.0.255
Maximum Demand Active export (-P) T1	1.0.2.6.1.255
Maximum Demand Active export (-P) T1 capture time	1.0.2.6.1.255
Maximum Demand Active export (-P) T2	1.0.2.6.2.255
Maximum Demand Active export (-P) T2 capture time	1.0.2.6.2.255
Maximum Demand Active export (-P) T3	1.0.2.6.3.255
Maximum Demand Active export (-P) T3 capture time	1.0.2.6.3.255
Maximum Demand Active export (-P) T4	1.0.2.6.4.255
Maximum Demand Active export (-P) T4 capture time	1.0.2.6.4.255
Cumulative Maximum Demand Active total ( +P + -P )	1.0.15.2.0.255
Cumulative Maximum Demand Active total ( +P + -P ) T1	1.0.15.2.1.255
Cumulative Maximum Demand Active total ( +P + -P ) T2	1.0.15.2.2.255
Cumulative Maximum Demand Active total ( +P + -P ) T3	1.0.15.2.3.255
Cumulative Maximum Demand Active total ( +P + -P ) T4	1.0.15.2.4.255
Cumulative Maximum Demand Active import (+P) total	1.0.1.2.0.255
Cumulative Maximum Demand Active import (+P) T1	1.0.1.2.1.255
Cumulative Maximum Demand Active import (+P) T2	1.0.1.2.2.255
Cumulative Maximum Demand Active import (+P) T3	1.0.1.2.3.255
Cumulative Maximum Demand Active import (+P) T4	1.0.1.2.4.255
Cumulative Maximum Demand Active export (-P) total	1.0.2.2.0.255
Cumulative Maximum Demand Active export (-P) T1	1.0.2.2.1.255
Cumulative Maximum Demand Active export (-P) T2	1.0.2.2.2.255
Cumulative Maximum Demand Active export (-P) T3	1.0.2.2.3.255
Cumulative Maximum Demand Active export (-P) T4	1.0.2.2.4.255
Average power factor of current month	1.0.13.24.128.255
*Available credit	0.0.19.0.0.255
*Charge energy of current month	1.0.140.129.1.255
*Current month consumption energy	1.0.140.129.2.255

Table: Monthly billing capture objects

\*Note: 1. capture objects with symbol "\*" are not present when meter is in post-payment mode, it will automatically be added to capture objects when meter switches to prepayment mode.

2. for CT, CTPT meter, capture objects with symbol "\*" are not applicable.

### Billing period counter

The object is used to record the number of monthly billing. It starts with 00 and increments with every historical reset. (First historical value identified with 01). This value will not reset to 00 even if the billing data is cleared.

### End of billing period/ MDI reset

The billing date and time. The default value is 00:00:00 of the 1st day in every month

### End of billing period script table

This object is used for billing and triggered on a regular basis by a scheduler (synchronously) and/or asynchronously by events:

- 1) When passive tariff is activated, the meter will trigger a billing.
- 2) Automatic billing based on the time specified in “End of billing period/ MDI reset“ object.
- 3) By a remote or local billing command.
- 4) From post-payment mode to prepayment mode, and vice versa. *This is applicable only in SP and PPDC meter.*

## 15 Load Profiles

The following objects support this functionality:

Object / Attribute Name	Class	Ver.	OBIS code
Profile status – Energy load profile	1	0	0-0:96.10.1.255
Energy Load Profile	7	1	1-0:99.1.0.255
Profile status – Daily profile	1	0	0-0:96.10.2.255
Daily Load Profile	7	1	1-0:99.2.0.255
Profile status – Power quality profile	1	0	1.0.96.10.1.255
Power Quality Load Profile	7	1	1-0:99.14.0.255

Table: load profile

### 15.1 Energy Load Profile

Capacity:	240 days with 60 minutes (exactly 5760 entries)
Capture_period:	Configurable range: 5/10/15/30/60 minutes, default 60 minutes
Captured_objects:	Refer to the below table
Buffer encoding:	<b>option 1:</b> normal: clock with every entry <b>option 2:</b> compressed: if any element can be deducted from the previous buffer entry, then the type “null data” is used. for values: the same as the previous for clock: previous + capture period
Selective access:	by range and by entry
Sorted method:	unsorted (FIFO)

The default capture objects:

Capture Objects	OBIS code
Clock	0.0.1.0.0.255
Profile status– Energy load profile	0.0.96.10.1.255
Active energy total ( +A + -A )	1.0.15.8.0.255
Active energy import (+A)	1.0.1.8.0.255
Active energy export (-A)	1.0.2.8.0.255
Reactive energy total ( +R + -R )	1.0.128.8.0.255
Reactive energy import(+R)	1.0.3.8.0.255
Reactive energy export(-R)	1.0.4.8.0.255
Instantaneous status word	0.0.96.10.6.25

Table: energy profile capture objects

Note: registers related to “Reactive Energy” are not applicable in single-phase meter.

## 15.2 Daily Load Profile

Capacity:	31 days with 24 hours (exactly 31 entries)
Structure:	clock.time, profile_status, values
Capture_period:	24 hours
Captured_objects:	Refer to the below table
Buffer encoding:	<p><b>option 1:</b> normal: clock with every entry</p> <p><b>option 2:</b> compressed: if any element can be deducted from the previous buffer entry, then the type “null data” is used.</p> <p>for values: the same as the previous</p> <p>for clock: previous + capture period</p>
Selective access:	by range and by entry
Sorted method:	unsorted (FIFO)

The default capture objects:

Capture Objects	OBIS code
Clock	0.0.1.0.0.255
Profile status – Daily profile	0.0.96.10.2.255
Active energy total ( +A + -A )	1.0.15.8.0.255
Active energy total ( +A + -A ) T1	1.0.15.8.1.255
Active energy total ( +A + -A ) T2	1.0.15.8.2.255
Active energy total ( +A + -A ) T3	1.0.15.8.3.255
Active energy total ( +A + -A ) T4	1.0.15.8.4.255
Active energy import (+A)	1.0.1.8.0.255
Active energy import (+A) T1	1.0.1.8.1.255
Active energy import (+A) T2	1.0.1.8.2.255
Active energy import (+A) T3	1.0.1.8.3.255
Active energy import (+A) T4	1.0.1.8.4.255
Active energy export (-A)	1.0.2.8.0.255
Active energy export (-A) T1	1.0.2.8.1.255
Active energy export (-A) T2	1.0.2.8.2.255
Active energy export (-A) T3	1.0.2.8.3.255
Active energy export (-A) T4	1.0.2.8.4.255

Reactive energy total ( +R + -R )	1.0.128.8.0.255
Reactive energy total ( +R + -R ) T1	1.0.128.8.1.255
Reactive energy total ( +R + -R ) T2	1.0.128.8.2.255
Reactive energy total ( +R + -R ) T3	1.0.128.8.3.255
Reactive energy total ( +R + -R ) T4	1.0.128.8.4.255
Reactive energy import(+R)	1.0.3.8.0.255
Reactive energy import(+R) T1	1.0.3.8.1.255
Reactive energy import(+R) T2	1.0.3.8.2.255
Reactive energy import(+R) T3	1.0.3.8.3.255
Reactive energy import(+R) T4	1.0.3.8.4.255
Reactive energy export(-R)	1.0.4.8.0.255
Reactive energy export(-R) T1	1.0.4.8.1.255
Reactive energy export(-R) T2	1.0.4.8.2.255
Reactive energy export(-R) T3	1.0.4.8.3.255
Reactive energy export(-R) T4	1.0.4.8.4.255
Instantaneous status word	0.0.96.10.6.25
Maximum Demand Active total ( +P + -P ) (Daily Reset)	1.0.15.6.128.255 (attribute 2)
Maximum Demand Active total ( +P + -P ) capture time (Daily Reset)	1.0.15.6.128.255 (attribute 5)
Maximum Demand Active import(+P) (Daily Reset)	1.0.1.6.128.255 (attribute 2)
Maximum Demand Active import(+P) capture time (Daily Reset)	1.0.1.6.128.255 (attribute 5)
Maximum Demand Active export(-P) (Daily Reset)	1.0.2.6.128.255 (attribute 2)
Maximum Demand Active export(-P) capture time (Daily Reset)	1.0.2.6.128.255 (attribute 5)
*Available credit	0.0.19.0.0.255

Table: daily load profile capture objects

**\*Note:**

1. capture objects with symbol “\*” are not present when meter is in post-payment mode, it will automatically be added to capture objects when meter switches to prepayment mode.
2. for CT, CTPT meter, capture objects with symbol “\*” are not applicable.
3. registers related to “Reactive Energy” are not applicable in single-phase meter.

EPADS

### 15.3 Load Profile Status

In all load profiles a simplified status code is used for every entry.  
The Profile Status code has a size of 1 byte and it is shown in hexadecimal form.

The following table describes the state and the function of all bits:

Bit #	Description
Bit 7 PDN	<b>Power down:</b> This bit is set to indicate that a total power outage has been detected during the affected capture period.
Bit 6	<b>Reserved:</b> The reserved bit is always set to 0.
Bit 5 CAD	<b>Clock adjusted:</b> The bit is set when the clock has been adjusted by more than the synchronization limit.
Bit 4	<b>Reserved</b>
Bit 3 DST	<b>Daylight saving:</b> Indicates whether or not the daylight saving time is currently active. The bit is set if the daylight saving time is active (summer) and cleared during normal time (winter).
Bit 2 DNV	<b>Data not valid:</b> Indicates that the current entry may not be used for billing purposes without further validation because a special event has occurred.
Bit 1 CIV	<b>Clock invalid:</b> The power reserve of the calendar clock has been exhausted. The time is declared as invalid. At the same time the DNV bit is set.
Bit 0 ERR	<b>Critical error:</b> A serious error such as a hardware failure or a checksum error has occurred. If the ERR bit is set then also the DNV bit is set.

Table: profile status

### 15.4 Special Events

This section describes how different event affect the load profile. A 30 minutes period load profile will be used for the example.

#### 15.4.1 Power Failure Over the Capture Period

In case of power failure (for three-phase meter, all phase power failure), the meter marks PDN =1 in the load profile status of the affected periods. The periods without power for full period will not be added in the load profile.

For example, when meter power down at 2016-02-15 23:46:00, and power on at 2016-02-16 01:31:00:

Date / Time	Load Profile Status							Register_1	Register_2
	PDN	RSV	CAD	DST	DNV	CIV	ERR		
2016-02-15 / 22:30:00	0	0	0	0	0	0	0	1000	118
2016-02-15 / 23:30:00	0	0	0	0	0	0	0	1020	132
2016-02-16 / 00:00:00	1	0	0	0	0	0	0	1025	134
2016-02-16 / 02:00:00	1	0	0	0	0	0	0	1040	138
2016-02-16 / 02:30:00	0	0	0	0	0	0	0	1066	156

#### 15.4.2 Clock Setting

In case adjusting the clock backwards, the meter marks CAD =1 in the load profile status of the affected periods. If the new clock is in different period from current period, the current period shall be ended with CAD = 1.

If clock is adjusted backwards, the old periods from the new clock will NOT be overwritten.

For example: adjust clock from 03:16:00 to 01:46:00. Profiles before adjusting clock:

Date / Time	Load Profile Status							Register_1	Register_2
	PDN	RSV	CAD	DST	DNV	CIV	ERR		
2016-02-27 / 01:00:00	0	0	0	0	0	0	0	1000	118
2016-02-27 / 01:30:00	0	0	0	0	0	0	0	1010	129

2016-02-27 / 02:00:00	0	0	0	0	0	0	0	1020	132
2016-02-27 / 02:30:00	0	0	0	0	0	0	0	1025	134
2016-02-27 / 03:00:00	0	0	0	0	0	0	0	1040	138

Profiles after adjusting clock:

Date / Time	Load Profile Status							Register_1	Register_2
	PDN	RSV	CAD	DST	DNV	CIV	ERR		
2016-02-27 / 01:00:00	0	0	0	0	0	0	0	1000	118
2016-02-27 / 01:30:00	0	0	0	0	0	0	0	1010	129
2016-02-27 / 02:00:00	0	0	0	0	0	0	0	1020	132
2016-02-27 / 02:30:00	0	0	0	0	0	0	0	1025	134
2016-02-27 / 03:00:00	0	0	0	0	0	0	0	1040	138
2016-02-27 / 03:30:00	0	0	1	0	0	0	0	1045	140
2016-02-27 / 02:00:00	0	0	1	0	0	0	0	1050	142
2016-02-27 / 02:30:00	0	0	0	0	0	0	0	1072	160

If the clock is adjusted forward, the periods which are fully crossed will not be added. If the new clock is in different period from current period, the current period shall be ended with CAD = 1. The CAD will be set to 1 in the load profile status of the first period from the new clock.

For example, adjust clock from 01:46:00 to 03:16:00. Profiles before adjusting clock:

Date / Time	Load Profile Status							Register_1	Register_2
	PDN	RSV	CAD	DST	DNV	CIV	ERR		
2016-02-27 / 01:00:00	0	0	0	0	0	0	0	1000	118
2016-02-27 / 01:30:00	0	0	0	0	0	0	0	1010	129

Profiles after adjusting clock:

Date / Time	Load Profile Status							Register_1	Register_2
	PDN	RSV	CAD	DST	DNV	CIV	ERR		
2016-02-27 / 01:00:00	0	0	0	0	0	0	0	1000	118
2016-02-27 / 01:30:00	0	0	0	0	0	0	0	1010	129
2016-02-27 / 02:00:00	0	0	1	0	0	0	0	1014	130
2016-02-27 / 03:30:00	0	0	1	0	0	0	0	1019	133
2016-02-27 / 04:00:00	0	0	0	0	0	0	0	1040	138

### 15.4.3 Clock Invalid

If meter's clock is invalid, the CIV and DNV will be set to 1.

For example, the meter power off at 2016-02-16 23:20:00, supposing the meter backup power supply is used up during the power off period, after power on at 2016-02-17 01:25:00, the meter's clock becomes invalid, but it will start from the moment of the power off. Supposing the meter's clock is synchronized at 2016-02-17 02:46:00, the load profile looks as below:

Date / Time	Load Profile Status							Register_1	Register_2
	PDN	RSV	CAD	DST	DNV	CIV	ERR		
2016-02-15 / 22:30:00	0	0	0	0	0	0	0	1000	118
2016-02-15 / 23:00:00	0	0	0	0	0	0	0	1010	129
2016-02-15 / 23:30:00	1	0	0	0	1	1	0	1015	131
2016-02-16 / 00:00:00	0	0	0	0	1	1	0	1028	143
2016-02-16 / 00:30:00	0	0	0	0	1	1	0	1050	155
2016-02-16 / 01:00:00	0	0	1	0	1	1	0	1076	161
2016-02-16 / 03:00:00	0	0	1	0	0	0	0	1092	172
2016-02-16 / 03:30:00	0	0	0	0	0	0	0	1112	188

## 16 Load Control Management

The meter can control the relay for the load management or the meter status. Disconnection and reconnection of the relay is supported by the following objects:

Object / Attribute Name	Class	Ver.	OBIS code
Disconnect control script table	9	0	0-0:10.0.106.255
Disconnect control	70	0	0-0:96.3.10.255
Contract power threshold	3	0	1-0:1.35.0.255
Activity calendar for Demand Control	20	0	0-0:13.0.4.255
Demand control script table	9	0	0-0:10.0.112.255
Active demand control threshold set	1	0	1.0.130.0.0.255
Passive demand control threshold set	1	0	1.0.130.0.1.255
Current active demand control threshold	3	0	1-0:1.35.1.255
Current demand control threshold index	1	0	0-0:96.128.10.255
Demand control function enable	1	0	1-0:96.0.161.255
Limiter power time threshold	3	0	1-0:1.44.1.255
Limiter power restore time threshold (Auto-reconnection)	3	0	1-0:1.43.0.255
Auxiliary Disconnect control	70	0	0-1:96.3.10.255
Max number of auto reconnection	1	0	0-0:96.135.0.255
No more reconnection flag	1	0	0-0:96.140.0.255

Table: Load control objects

### No more reconnection flag

When the number of auto-reconnection reaches the max number of auto reconnection, the meter will not reconnect, and the no more reconnection flag will be set. Only after the flag is cleared via the HES, the accumulated reconnect count will also be cleared, so that the meter will automatically reconnect again.

### Auxiliary Disconnect control

This object is only available in CT and CTPT meter, which is used to control external breaker or device.

The state diagram for disconnector and the possible state transitions are shown in the figure below:

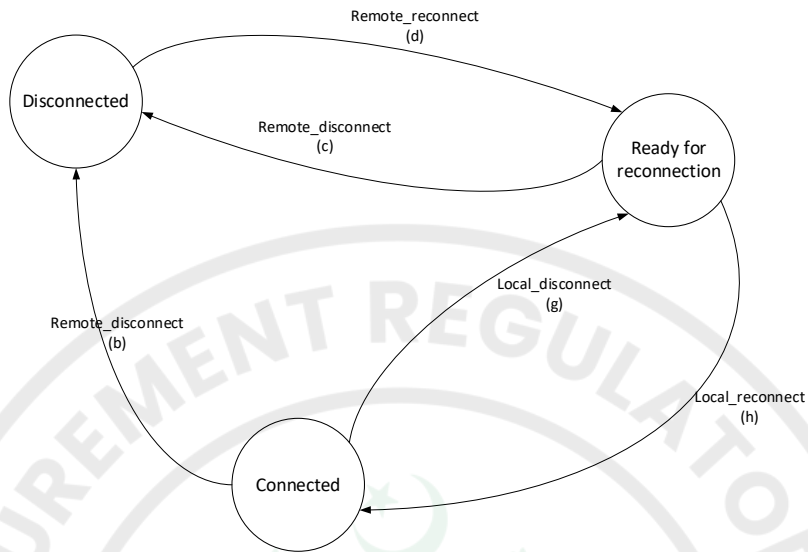

Figure 3: Disconnector state transitions

### Disconnect control script table

The disconnect script table contains the following scripts:

Script identifier	Action
1	{2,70,0-0:96.3.10.255,1,0x00}, remote_disconnect
2	{2,70,0-0:96.3.10.255,2,0x00}, remote_reconnect

### Disconnect control

The behaviour of the relay includes remote, local and manual disconnection or reconnection. These commands are dependent by the control\_mode setting of the **Disconnect control** object.

control_mode	Disconnection				Reconnection			
	Remote	Manual	Local		Remote	Manual	Local	
enum:	(b)	(c)	(f)	(g)	(a)	(d)	(e)	(h)
(0)	–	–	–	–	–	–	–	–
(1)	x	x	x	x	–	x	x	–
(2)	x	x	x	x	x	–	x	–
(3)	x	x	–	x	–	x	x	–
(4)	x	x	–	x	x	–	x	–
(5)	x	x	x	x	–	x	x	x
(6)	x	x	–	x	–	x	x	x

NOTE 3 In Mode (0) the disconnect control object is always in 'connected' state.

NOTE 4 Local disconnection is always possible unless the corresponding trigger is inhibited.

Figure 4: Disconnection mode

The meter support control mode: 6.

If the state transition is not allowed by the control mode, then the action is ignored.

### Auxiliary Disconnect control

This object is used for auxiliary relay of three phase CT /CTPT meter. The auxiliary relay executes the same control logic as that of Disconnect Control.

The CT/CTPT meter support auxiliary disconnect control for power limitation, demand side management, and over current.

### 16.1 Power Limitation

The meter measures the active power every second. If the import active power is larger than the active power thresholds for specified period t1, the meter will disconnect the supply. After disconnect last for auto-reconnect time t2, the meter will automatically connect the supply. If the customer does not reduce the load, the over load will be detected again, then the meter will disconnect the supply again. After counter of auto-reconnect reaches Max Number of Auto-reconnect, if it is disconnected once again due to over load, the meter will keep in disconnection status, only a command that clear the disconnect counters is received by the meter can connect the supply.

The meter records a counter of auto-reconnect attempted. The counter will be reset after the power below the power threshold, or after a power off, or after executing an clear disconnect counters command from remote central system or local hand-held device when allowed auto-reconnect counters is used up.

Here below picture show the load control process:

Here below picture show the load control process for one power threshold.

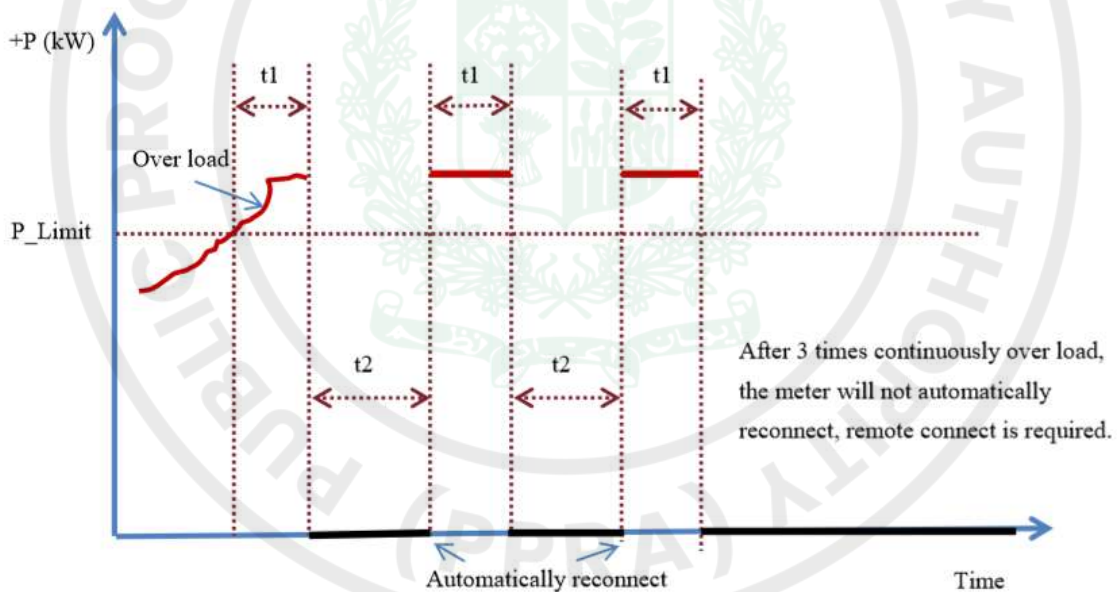

Over load parameters, ranges, and default values:

Parameter	Unit	Min. Value	Max. Value	Default Value
Power limiter threshold (P_limit)	kW	0	$Un * I_{max} * 3 * 1.0$	$Un * I_{max} * 3 * 0.9$
Power limiter time threshold (t1)	Second	5	3600	180
Power limiter restore time threshold (Auto-reconnect time) (t2)	Second	5	3600	180
Max. Number of auto-reconnect for Power limiter	/	0	5	2

Object / Attribute Name	Class	Ver.	OBIS code
Power limiter threshold	3	0	1-0.11.35.4.255
Power limiter time threshold	3	0	1-0:1.44.1.255
Power limiter restore time threshold (Auto-reconnect time)	3	0	1-0:1.43.0.255

Max. Number of auto-reconnect for Power limiter	1	0	0-0:96.135.0.255
---	---	---	------------------

During over power period, but the number of auto-reconnect has not been exceeded, after the meter is automatically reconnected, if no over power is generated again with  $(t1 * 2)$  seconds, the number of auto-reconnect will be reset.

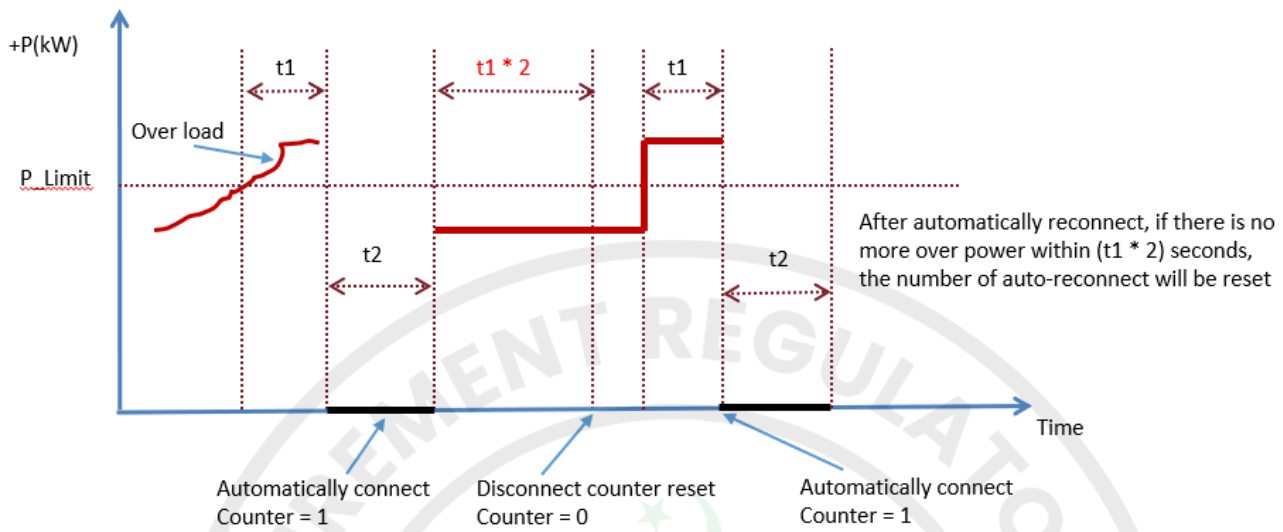

### Power limit enable/disable

The function to monitor the active power can be switched on/off. The default state is enable. If the power thresholds are zero, the active power limitation is disabled.

## 16.2 Demand Control

Demand Control functionality is used to reduce peak loads.

### Activity calendar for Demand Control

The activity calendar must support at least:

- season\_profile => at least 4 seasons
- week\_profile\_table => at least 4 entries
- day\_profile\_table => at least 4 entries
- day\_profile => up to 24 switching times per day

### Demand control script table

The demand control script table supports up to 8 switching scripts.

Script identifier	Action
1	Power threshold 1 are activated
2	Power threshold 2 are activated
3	Power threshold 3 are activated
4	Power threshold 4 are activated
5	Power threshold 5 are activated
6	Power threshold 6 are activated
7	Power threshold 7 are activated
8	Power threshold 8 are activated

### **Demand control threshold set**

The demand control threshold set contains two set of power threshold, “Active demand control threshold set” and “Passive demand control threshold set”, the data structure of demand control threshold set is as follows:

```
Demand_control_threshold ::= ARRAY
{
    Double_long_unsigned : threshold[8]
}
```

The demand control threshold set supports up to 8 power thresholds.

The passive demand control threshold set is configurable, when the activity calendar for demand control is activated, the active demand control threshold will be replaced with passive demand control threshold set.

The index of active demand control threshold set corresponds to script identifier of demand control script table. For example, when identifier 2 is invoked, the 2<sup>nd</sup> threshold defined in active demand control threshold set will become active.

When active demand control threshold set has 0 elements of power thresholds, this functionality is disabled.

When clock is invalid, this functionality is disabled.

### **Current active demand control threshold**

This object shows current active demand control threshold

### **Load shedding**

When current active demand control threshold is 0, means the meter is under load shedding condition.

In this situation, the meter will disconnect immediately, and the LCD will display “OFF-SHED”. The meter will reconnect by itself when meter exits load shedding condition.

### **Demand control function enable**

Demand control functionality can enable or disable, when the functionality is disabled, the meter will not detect demand control function any more.

When enabled, The limitation and disconnection mechanism is same as 16.1 Power Limitation, they share the same set of t1, t2 and the number of auto-reconnect.

## **16.3 Over Current**

To protect the meter, if the current of any phase is bigger than over current threshold for 1 minutes, the meter will automatically disconnect the power supply. After 1 minutes, the meter will automatically reconnect the power supply. If the customer does not reduce the current, the over current will be detected again, then the meter will disconnect the power supply again. After consecutive 2 times automatic reconnection, if it is disconnected once again due to over current, the meter will keep in disconnection status, only a connect command can connect the supply. During the disconnection period, the meter will display “OFF-OC”.

When current is over the current threshold of maximum allowable disconnect, the relay switching is inhibited.

The logic of over current has a separate set of t1, t2 and the number of auto-reconnect, which are different from Power Limitation and Demand Side Management (16.1 & 16.2).

the current threshold of maximum allowable disconnect is 60A for SP, 120A for PPDC.

Over load parameters, ranges, and default values:

Parameter	Unit	Min. Value	Max. Value	Default Value
Over current threshold	A	0.5 * I <sub>max</sub>	1.3 * I <sub>max</sub>	1.1 * I <sub>max</sub>
Over current time threshold (t1)	Second	5	3600	60
Over current restore time threshold (auto-reconnect time) (t2)	Second	5	3600	60
Max. Number of auto-reconnect for Over current	/	0	5	2

Object / Attribute Name	Class	Ver.	OBIS code
Over current threshold	3	0	1-0.11.35.4.255
Over current time threshold	3	0	1-0.11.44.3.255
Over current restore time threshold (auto-reconnect time)	3	0	1-0.11.44.8.255
Max. Number of auto-reconnect for Over current	1	0	0-0:96.136.0.255

## 16.4 Tamper Disconnect

Some events may trigger the meter disconnect the power supply. the following objects are used to enable or disable the disconnect control once the corresponding events happens.

Object / Attribute Name	Class	Ver.	OBIS code
Switch of meter cover open relay disconnect	1	0	1-0.96.0.130.255
Switch of meter terminal open relay disconnect	1	0	1-0.96.0.131.255
Switch of meter magnetic disturbance relay disconnect	1	0	1-0.96.0.132.255
Switch of meter current reverse relay disconnect	1	0	1-0.96.0.134.255
Switch of meter DC injection relay disconnect	1	0	1-0.96.0.145.255
Switch of meter ESD disturbance relay disconnect	1	0	1-0.96.0.146.255
Switch of meter load unbalance relay disconnect	1	0	1-0.96.0.147.255
Switch of meter voltage THD exceed limit relay disconnect	1	0	1-0.96.0.148.255
Switch of meter current THD exceed limit relay disconnect	1	0	1-0.96.0.149.255

Every object above can be set TRUE or FALSE. When the value is TRUE, the relay will automatically disconnect once corresponding event occurs.

For “ Switch of meter load unbalance relay disconnect“, it’s only applicable in PPDC and CT,CTPT meter.

For “ Switch of meter voltage THD exceed limit relay disconnect“ and “ Switch of meter current THD exceed limit relay disconnect“, they are only applicable in CT,CTPT meter.

## 17 Display

The meter provides user interfaces to display the meter data and status information. The following objects support this functionality:

Object / Attribute Name	Class	Ver.	OBIS code
Auto scroll display readout	7	1	0-0:21.0.1.255
Manual scroll display readout	7	1	0-0:21.0.2.255

The display objects shall

be configurable via attribute 3 “capture\_objects”.

In “auto scroll display readout” and “manual scroll display readout”, attribute 4 “capture period” is used to indicate display interval. When “capture period” is reached, the meter will switch to the next screen for display in Auto scroll mode, or return back to Auto scroll mode from Manual scroll mode.

## 18 Event Management

Event is categorized in different group. Each group has different events and stored in an event log object. Each group of event has a filter objects with a bit-mask for each event to define whether the corresponding events shall be pushed (0: disable, 1: enable) to the system once it occurs.

### 18.1 Standard Event Log

The following objects support this functionality:

Object / Attribute Name	Class	Ver.	OBIS code
Standard event log	7	1	0-0:99.98.0.255
Standard event filter	1	0	0-1:94.14.105.255
Event code - Standard event log	1	0	0-0:96.11.0.255

Table: Standard Event Log

#### Standard Event Log

min capacity: minimum of 50 entries

structure: clock.time, value

capture period: 0 (externally triggered)

captured objects: {0-0:1.0.0.255, clock}  
{0-0:96.11.0.255, code}

buffer encoding: normal: clock with every entry

selective access: by range and by entry

sorted method: unsorted (FIFO)

### 18.2 Fraud Event Log

The following objects support this functionality:

Object / Attribute Name	Class	Ver.	OBIS code
Fraud detection event log	7	1	0-0:99.98.1.255
Fraud detection event filter	1	0	0-1:94.14.106.255
Event code - Fraud detection event log	1	0	0-0:96.11.1.255

Table: Fraud Event Log

#### Fraud Event Log

min capacity: minimum of 50 entries

structure: clock.time, value

capture period: 0 (externally triggered)

captured objects: {0-0:1.0.0.255,clock}  
{0-0:96.11.1.255,code}

buffer encoding: normal: clock with every entry

selective access: by range and by entry

sorted method: unsorted (FIFO)

### 18.3 Disconnecter Control Event Log

The following objects support this functionality:

Object / Attribute Name	Class	Ver.	OBIS code
Disconnecter control event Log	7	1	0-0:99.98.2.255
Disconnecter control event filter	1	0	0-1:94.14.107.255
Event Code - Disconnecter control event log	1	0	0-0:96.11.2.255

Table: Disconnecter Control Event Log

#### Disconnecter Control Event Log

min capacity: minimum of 50 entries  
 structure: clock.time, value  
 capture period: 0 (externally triggered)  
 captured objects: {0-0:1.0.0.255,clock}  
                           {0-0:96.11.2.255,code}  
 buffer encoding: normal: clock with every entry  
 selective access: by range and by entry  
 sorted method: unsorted (FIFO)

### 18.4 Power Failure Event Log

The following objects support this functionality:

Object / Attribute Name	Class	Ver.	OBIS code
Power failure event log	7	1	1-0:99.97.0.255
Power failure event filter	1	0	0-1:94.14.109.255
Event Code - Power failure event log	1	0	0-0:96.11.6.255
Duration of last long power failure in any phase	3	0	0-0:96.7.19.255

Table: Power Failure Event Log

#### Power Failure Event Log

min capacity: minimum of 50 entries  
 structure: clock.time, value  
 capture period: 0 (externally triggered)  
 captured objects: {0-0:1.0.0.255, clock}  
                           {0-0:96.11.6.255, code}  
                           {0-0:96.7.19.255, Duration of last long power failure in any phase}  
 buffer encoding: normal: clock with every entry  
 selective access: by range and by entry  
 sorted method: unsorted (FIFO)

## 18.5 Power Quality Event Log

The following objects are supported to record the event:

Object / Attribute Name	Class	Ver.	OBIS code
Power quality event log	7	1	0-0:99.98.4.255
Power quality event filter	1	0	0-1:94.14.108.255
Event Code - Power quality event log	1	0	0-0:96.11.4.255

Table: Power Quality Event Log

### Power Quality Event log

min capacity: minimum of 50 entries  
 structure: clock.time, value  
 capture\_period: 0 (externally triggered)  
 captured objects: {0-0:1.0.0.255,clock}  
                           {0-0:96.11.4.255,code}  
 buffer encoding: normal: clock with every entry  
 selective access: by range and by entry  
 sorted method: unsorted (FIFO)

## 18.6 Communication Event Log

The following objects are supported to record the event:

Object / Attribute Name	Class	Ver.	OBIS code
Communication event log	7	1	0-0:99.98.5.255
Communication event filter	1	0	0-1:94.14.117.255
Event Code - communication event log	1	0	0-0:96.11.5.255
Client address	1	0	0-0:96.129.0.255
Communication port	1	0	0-0:96.129.1.255

Table: Power Quality Event Log

### Communication Event log

min capacity: minimum of 50 entries  
 structure: clock.time, value  
 capture\_period: 0 (externally triggered)  
 captured objects: {0-0:1.0.0.255,clock}  
                           {0-0:96.11.5.255, code}  
                           {0-0:96.129.0.255, Client address }  
                           {0-0:96.129.1.255, Communication port }  
 buffer encoding: normal: clock with every entry  
 selective access: by range and by entry  
 sorted method: unsorted (FIFO)

## 18.7 Prepay Event Log

The following objects support this functionality:

Object / Attribute Name	Class	Ver.	OBIS code
Prepay event log	7	1	0-0:99.98.7.255
Prepay event filter	1	0	0-1:94.14.110.255
Event code - Prepay event log	1	0	0-0:96.11.7.255

Table: Standard Event Log

### Prepay Event Log

min capacity: minimum of 50 entries  
 structure: clock.time, value  
 capture period: 0 (externally triggered)  
 captured objects: {0-0:1.0.0.255, clock}  
                           {0-0:96.11.7.255, code}  
 buffer encoding: normal: clock with every entry  
 selective access: by range and by entry  
 sorted method: unsorted (FIFO)

## 18.8 Recharge Event Log

The following objects support this functionality:

Object / Attribute Name	Class	Ver.	OBIS code
Recharge event log	7	1	0-0:99.98.8.255
Event code - Recharge event log	1	0	0-0:96.11.8.255
Recharge event filter	1	0	0-1:94.14.111.255
Recharge sequence number	1	0	0-0:128.131.0.255
Recharge amount	3	0	1-0:141.129.0.255

Table: Recharge Event Log

### Recharge Event Log

min capacity: minimum of 50 entries  
 structure: clock.time, value  
 capture period: 0 (externally triggered)  
 captured objects: {0-0:1.0.0.255,clock}  
                           {0-0:96.11.8.255, recharge event code},  
                           {0-0:128.131.0.255, recharge sequence number}  
                           {1-0:141.129.0.255, recharge amount }  
 buffer encoding: normal: clock with every entry  
 selective access: by range and by entry  
 sorted method: unsorted (FIFO)

## 18.9 Communication module Event Log

The following objects support this functionality:

Object / Attribute Name	Class	Ver.	OBIS code
Communication module event log	7	1	0-0:99.98.10.255
Communication module event filter	1	0	0-1:94.14.119.255
Event code - Communication module event log	1	0	0-0:96.11.10.255

Table: Recharge Event Log

### Communication module Event Log

min capacity: minimum of 100 entries  
 structure: clock.time, value  
 capture period: 0 (externally triggered)  
 captured objects: {0-0:1.0.0.255,clock}  
                           {0-0:96.11.10.255, code }  
 buffer encoding: normal: clock with every entry  
 selective access: by range and by entry  
 sorted method: unsorted (FIFO)

## 18.10 Daily Event Log

The following objects support this functionality:

Object / Attribute Name	Class	Ver.	OBIS code
Daily event log	7	1	0-0:99.98.11.255
Event code - Daily event log	1	0	0-0:96.11.11.255

Table: Recharge Event Log

### Communication module Event Log

min capacity: minimum of 100 entries  
 structure: clock.time, value  
 capture period: 0 (externally triggered)  
 captured objects: {0-0:1.0.0.255,clock}  
                           {0-0:96.11.11.255, code }  
 buffer encoding: normal: clock with every entry  
 selective access: by range and by entry  
 sorted method: unsorted (FIFO)

The Daily Event Log is used for DCU/HES to regularly collect events every day, and all the above events will be recorded in the Daily Event Log one more time after they are generated.

## 19 Push Operations

The meter shall have the functionality that allows sending data to the HES, initiated by the meter. There are several occasions on which data may be ‘pushed’, i.e. sent to the HES without being explicitly requested, e.g.

- Meter registration
- Triggered by the meter due to events

The following object supports this functionality for all possible triggers:

Object / Attribute Name	Class	Ver.	OBIS code
Push script table	9	0	0-0:10.0.108.255

The Push script table contains references for all defined push setup objects:

Script_identifier	logical_name	description
5	0-0:25.9.0.255	Push Setup – On Connectivity

### 19.1 Meter Connectivity

The Push on Connectivity is triggered each time a new network connection is established.

The following objects support this functionality:

Object / Attribute Name	Class	Ver.	OBIS code
Push setup – On Connectivity	40	0	0-0:25.9.0.255

This object defines the data elements for pushing to the HES in case of establishing a network connectivity.

The data notification service is used for meter connectivity push.

The following objects should be defined in push\_object\_list by default:

Object / Attribute Name	Class	Ver.	OBIS code	attribute
Push setup – On Connectivity	40	0	0-0:25.9.0.255	1
Logical Device Name	1	0	0-0:42.0.0.255	2
Communication Type	1	0	0-0:128.128.0.255	2
Optional parameter	1	0	0-0:128.129.0.255	2

#### Communication type

The data type of this object is long-unsigned.

The upper byte is defined as follows:

“83” – 4G

“86” – LTE

The lower byte is used only when communication module is P2P module, e.g. NB/LTE/GPRS. The lower byte take value from the attribute 2 of the object “Auto Connect”.

Auto Connect	29	2	0-0:2.1.0.255
--------------	----	---	---------------

### Optional parameter

This parameter is used by different modules to carry corresponding required parameters.

For 4G modules:

Optional parameter :: structure

```
{  
    Device IP address :: double-long-unsigned  
    Port :: long-unsigned  
    Cell ID :: double-long-unsigned  
    RSRP signal quality :: integer  
    SINR signal quality :: integer  
    Frequency bands :: double-long-unsigned  
}
```

## 19.2 Event push

Event push is triggered by an event. When any bit in the event log filters is set to push, it means the event will be sent to HES, using the event notification service, initiated by the meter itself.

## 20 Self-Diagnosis

The following objects support this functionality:

Object / Attribute Name	Class	Ver.	OBIS code
Instantaneous status word	1	0	0-0:96.10.6.255
Tamper status word	1	0	0-0:96.10.7.255

### 20.1 Instantaneous Status Word

The meter can detect some abnormal status by itself, and set the corresponding bit in the following status word:

Bit No.	Description	Set Condition	Reset Condition
0	Clock invalid	Meter clock is invalid	Meter clock is re-configured
1	Measurement system error	A physical error in the measurement system	The measurement system is recovered
2	NVM(non-volatile memory) error	Physical error in the EEPROM or Flash	The NVM is recovered
3	RAM error	Physical error in the RAM	The RAM is recovered
4	Program memory error	The checksum of meter code area is wrong	The checksum of meter code area is correct
5	Battery low	Battery capacity is low	Battery capacity is restored
6	Missing neutral	Neutral line is lost	Neutral line is restored
7	Phase neutral interchange	Phase & neutral line are interchanged	Phase wires are connected correctly
8	Under voltage L1	Phase L1 voltage is lower than under voltage threshold	Phase L1 voltage returns to normal
9	Over voltage L1	Phase L1 voltage is higher than overvoltage threshold	Phase L1 voltage returns to normal
10	Terminal cover removal	Terminal cover is removed	Terminal cover is closed

Bit No.	Description	Set Condition	Reset Condition
11	Main cover removal	Main cover is removed	Main cover is closed
12	Strong magnetic field	Strong magnetic field is detected	Strong magnetic field disappears
13	ESD disturbance	ESD disturbance is detected	ESD disturbance no longer existed
14	Current bypass	Meter is under current bypass condition	Current bypass condition is no longer existed
15	DC injection (neutral disturbance)	Neutral disturbance is detected	Neutral disturbance no longer existed
16	Current reverse	Any phase of current is reverse	All phases of current are normal
17	Relay status bit0	bit0=0, bit1=0: Disconnected bit0=1, bit1=0: Connected bit0=0, bit1=1:	
18	Relay status bit1	Ready for reconnection	
19	Prepayment mode	Meter is in prepayment mode	Meter is in post-payment mode
20	Current without voltage	Any phase has current, but no voltage	All phases of voltage restored
21	Reserved		

Table: Instantaneous Status Word

## 20.2 Tamper Status Word

A 32-bit tamper status word is used to indicate which tampers have occurred in the meter. It can only be cleared by a clear tamper command.

Bit No.	Description	Set Condition	Reset Condition
0	Meter cover removal	Meter cover is removed	Meter cover is closed and clear tamper command is received
1	Terminal cover removal	Terminal cover is removed	Terminal cover is closed and clear tamper command is received
2	Strong magnetic field	Strong magnetic field is detected	Strong magnetic field disappears and clear tamper command is received
3	DC injection (neutral disturbance)	Neutral disturbance is detected	Neutral disturbance no longer exists and clear tamper command is received
4	ESD disturbance	ESD disturbance is detected	ESD disturbance no longer exists and clear tamper command is received
5	Current reverse	1) When Export Energy function switch OFF, if reverse current value and duration time over certain threshold, this bit will be set. 2) When Export Energy function switch ON, this bit will not be set.	1) When current reverse condition removed and tamper reset command is received 2) When Export Energy function switch ON, this bit will be reset.
6 ~31	Reserved		

## 21 Firmware Upgrade

The meter should support firmware upgrade referring to meter firmware upgrade procedure through the DLMS standard image transfer process.

This Companion Standard supports only a single instance of the Image Transfer. In case the meter supports the download of multiple parts of the firmware, it is the manufacturer's responsibility to ensure the proper identification and activation of these images.

The following objects support this functionality:

Object / Attribute Name	Class	Ver.	OBIS code
Image transfer	18	0	0-0:44.0.0.255
Image activation scheduler	22	0	0-0:15.0.2.255
Predefined Scripts - Image activation	9	0	0-0:10.0.107.255
Legal firmware version	1	0	1-0:0.2.0.255
Legal firmware signature	1	0	1-0:0.2.8.255
Application firmware version	1	0	1-1:0.2.0.255
Application firmware signature	1	0	1-1:0.2.8.255
Communication firmware version	1	0	1-2:0.2.0.255
Communication firmware signature	1	0	1-2:0.2.8.255

## 22 Prepayment Function

The prepayment function is only applicable in single-phase meter and three-phase DC meter.

The meter should support both post-payment mode and prepayment mode, and can be switched from post-payment mode to prepayment mode by command, and vice versa.

For prepayment mode:

- 1) The meter can receive credit in kWh from the central system or local communication port.
- 2) The meter will disconnect the power supply after credit is fully exhausted, and record and spontaneously report (if enabled) the disconnection event to the system.
- 3) The meter will record and report (if enabled) the low balance alarm event to the system when the remaining credit of the meter is less than the low credit threshold which is configurable.

When the meter is switched from post-payment mode to prepayment mode at the first time, the meter will disconnect automatically because the initial available credit of the meter is 0.

The maximum available credit is 99999.999 kWh.

The following objects support this functionality:

Object / Attribute Name	Class	Ver.	OBIS code
Account	111	0	0-0:19.0.0.255
Token Credit	112	0	0-0:19.10.0.255
Charge	113	0	0-0:19.20.0.255
Recharge	1	0	0-0:128.140.0.255
Recharge sequence number	1	0	0-0:128.131.0.255
Recharge Energy Of Current Month	3	0	1-0:140.129.1.255
Consumption Energy Of Current Month	3	0	1-0:140.129.2.255
Total Recharge Energy	3	0	1-0:140.129.3.255

Table: Prepayment function

## 22.1 Recharge

The “Recharge” object makes the meter capable of receiving energy from the system. The meter also manages a “recharge sequence number” to avoid the re-charge for the same command. The sequence number issued during each recharge must be greater than the sequence number issued during the last successfully recharge, otherwise recharge fails.

The datatype of “Recharge” is as follows:

Recharge ::= structure

```
{  
    Recharge_sequence_number: double-long-unsigned  
    Recharge_amount: double-long  
}
```

The security of Recharge is guaranteed by the DLMS security of the meter. Which means Recharge is only available on the encrypted dlms association.

## 22.2 Low Credit

The meter must support low credit alarm. When available credit is lower than low credit threshold, the meter should log the low credit event and report low credit alarm to the system. The low credit threshold is defined in “Token Credit” object.

## 22.3 Payment Mode Switch

The meter must support the mutual switching between post-payment and pre-payment mode. The attribute is defined in “Account” object. In post-payment mode, the meter does not accept energy recharge.

## 23 Appendix

### 23.1 Event Code

Event Code	Name	Standard Event Log	Fraud Detection Log	Disconnector Control Log	Power Quality Event Log	Power Failure Event Log	Communication Log	Communication module Log	recharge	payment	Push
1	short Power Down	X									
2	short Power Up	X									
3	Daylight saving time enabled or disabled	X									
4	Clock adjusted (old date/time)	X									
5	Clock adjusted (new date/time)	X									
6	Clock invalid	X									
8	Battery voltage low	X									√
9	TOU activated	X									
12	Program memory error	X									√
13	RAM error	X									√
14	NV memory error	X									√
15	Watchdog error	X									√
16	Measurement system error	X									√
17	Firmware ready for activation	X									
18	Firmware activated	X									
19	Passive TOU programmed	X									
21	long power down	X									√
22	long power up	X									√
23	Communication problems						X				√
24	Configuration problems						X				√
25	CT open L1 start ( CT only )		X								
26	CT open L1 start ( CT only )		X								
27	CT open L1 start ( CT only )		X								
28	CT open L1 end ( CT only )		X								
29	<del>CT open L2 end ( CT only )</del>		✕								
30	<del>CT open L3 end ( CT only )</del>		✕								
31	CT/PT mismatch start ( CT only )		X								
32	CT/PT mismatch end ( CT only )		X								
34	Clock out of tolerance	X									√
40	Terminal cover removed		X								√
41	Terminal cover closed		X								√

42	Strong DC field detected		X								√
43	No strong DC field anymore		X								√
44	Meter cover removed		X								√
45	Meter cover closed		X								√
47	One or more parameters changed	X									
48	Global key(s) changed	X									√
49	Decryption or authentication failure (n time failure)						X				
50	Replay attack						X				
51	FW verification failed	X									
53	ESD start		X								
54	ESD end		X								
55	Tamper register cleared	X									
62	Remote disconnection			X							√
65	Power limiter threshold exceeded			X							
66	Power Limiter threshold ok			X							
67	Limiter threshold config changed			X							
69	Local reconnection			X							√
70	Over current L1 start			X							√
71	Over current L1 end			X							√
72	Over current L2 start			X							X
73	Over current L2 end			X							X
74	Over current L3 start			X							X
75	Over current L3 end			X							X
76	Undervoltage L1				X						
77	Undervoltage L2				X						
78	Undervoltage L3				X						
79	Overvoltage L1				X						
80	Overvoltage L2				X						
81	Overvoltage L3				X						
82	Missing voltage L1				X						
83	Missing voltage L2				X						
84	Missing voltage L3				X						
85	Voltage L1 normal				X						
86	Voltage L2 normal				X						
87	Voltage L3 normal				X						
88	Phase sequence reversal		X								√
89	Missing neutral ( PP only )		X								√
90	Load unbalance start				X						
140	P2P: No connection timeout							X			
142	P2P:SIM Card failure							X			
143	P2P:SIM Card ok							X			

144	P2P:Modem registration failure							X			
146	P2P:PDP context established							X			
147	P2P:PDP context destroyed							X			
148	P2P:PDP context failure							X			
149	P2P:Modem reboot							X			
156	P2P: Signal quality low							X			
200	Current in absence of voltage at L1 detected <b>(SP,CT only)</b>		X								
201	<del>Current in absence of voltage at L2 detected <b>(CT only)</b></del>		✖								
202	<del>Current in absence of voltage at L3 detected <b>(CT only)</b></del>		✖								
204	Current Reversal L1		X								√
205	<del>Current Reversal L2</del>		✖								✖
206	<del>Current Reversal L3</del>		✖								✖
207	Current Reversal L1 end		X								√
208	<del>Current Reversal L2 end</del>		✖								✖
209	<del>Current Reversal L3 end</del>		✖								✖
210	Long power failure in all phases <b>(PP only)</b>					X					
211	Long power failure in phase1					X					
212	<del>Long power failure in phase2 <b>(PP only)</b></del>					✖					
213	<del>Long power failure in phase3 <b>(PP only)</b></del>					✖					
214	Communication module removed		X								
215	Communication module inserted		X								
226	Firmware activation failed	X									
229	Phase sequence reversal end		X								√
230	Load unbalance end					X					
236	DC injection(neutral disturbance) start		X								√
237	DC injection(neutral disturbance) end		X								√
240	missing neutral end <b>( PP only )</b>		X								√
241	phase neutral exchange L1 start		X								√
242	<del>phase neutral exchange L2 start</del>		✖								✖
243	<del>phase neutral exchange L3 start</del>		✖								✖
244	phase neutral exchange L1 end		X								√
245	<del>phase neutral exchange L2 end</del>		✖								✖
246	<del>phase neutral exchange L3 end</del>		✖								✖
249	current bypass start		X								

250	current bypass end		X							
251	Current in absence of voltage at L1 detected end (SP, CT only)		X							
252	Current in absence of voltage at L2 detected end (CT only)		X							
253	Current in absence of voltage at L3 detected end (CT only)		X							
254	Load profile cleared	X								
255	Event log cleared	X	X	X	X	X	X		X	
384	meter recharge							X		
385	low credit								X	√
392	switch to PRE-PAYMENT mode								X	
393	switch to POST PAYMENT mode								X	
396	configure passive unit charge								X	
401	Credit exhausted								X	√
402	configure low credit threshold								X	
403	clear recharge sequence number								X	
404	activate passive unit charge								X	
421	Communication start on local interface						X			
422	Communication end on local interface						X			
423	Local disconnection due to meter cover removal			X						√
424	Local disconnection due to terminal cover removal			X						√
425	Local disconnection due to strong DC magnetic field			X						√
426	Local disconnection due to current reverse			X						√
427	Local disconnection due to ESD disturbance			X						√
428	Local disconnection due to DC injection			X						√
429	Local disconnection due to credit exhausted			X						√
430	Local disconnection due to over power			X						√
431	Local disconnection due to over demand side threshold			X						√
432	Local disconnection due to over current			X						√
433	Demand side limiter threshold exceeded			X						
434	Demand side limiter threshold ok			X						
435	Demand side threshold configured			X						

436	Local disconnection due to load unbalance			X							√
437	Local disconnection due to voltage THD exceed limit (CT only)			X							√
438	Local disconnection due to current THD exceed limit (CT only)			X							√
439	Local disconnection due to load shedding			X							√
450	P2P: Modem reset timer expired							X			
451	P2P: Modem listen failed							X			
452	P2P: Modem communication ready							X			
453	P2P: TCP connection establish failed							X			
454	P2P: Image download succeed							X			
455	P2P: Image download failed							X			
456	P2P: Image upgrade succeed							X			
457	P2P: Image upgrade failed							X			
458	PLC: No connection timeout							X			
459	PLC: Modem Registration Success							X			
460	PLC: Modem Registration Failure							X			
461	PLC: Modem Kicked							X			
462	PLC: Modem HW Reset							X			
463	PLC: Modem Request to Reset							X			
464	PLC: Modem Initialize Failure							X			
465	PLC: Modem Data Request Failure							X			
466	PLC: ICMP RA Received							X			
467	PLC: ICMP RS Failure							X			
468	PLC: ICMP Echo Request Received							X			
469	PLC: PAN Conflict Detected							X			
470	PLC: No PAN Detected							X			
480	voltage THD exceed limit (CT only)				X						√
481	voltage THD restore (CT only)				X						√
482	current THD exceed limit (CT only)				X						√
483	current THD restore (CT only)				X						√

## 23.2 Display Objects

The default display objects for auto scroll mode are described as follows:

index	Logical name	obis	Description	S	P	P	D	C	L	V	C	T	H	V	C	T
1	{1,0-0:96.128.0.255,2},	/	Display all segment													
2	{1,0-0:96.1.0.255,2},	96.1.0	Device ID1, manufacturing number	√												
3	{1,1-0:0.9.1.255,2},	0.9.1	local time							√	√	√	√			
4	{1,1-0:0.9.2.255,2},	0.9.2	local date							√	√	√	√			
5	{3,1-0:1.8.0.255,2},	1.8.0	Active energy import (+A)	√						√	√	√	√			
6	{3,1-0:1.8.1.255,2},	1.8.1	Active energy import (+A) T1							√	√	√	√			
7	{3,1-0:1.8.2.255,2},	1.8.2	Active energy import (+A) T2							√	√	√	√			
8	{3,1-0:2.8.0.255,2},	2.8.0	Active energy export (-A)	√						√	√	√	√			
9	{3,1-0:2.8.1.255,2},	2.8.1	Active energy export (-A) T1							√	√	√	√			
10	{3,1-0:2.8.2.255,2},	2.8.2	Active energy export (-A) T2							√	√	√	√			
11	{3,1-0:3.8.0.255,2},	3.8.0	Reactive energy import (+R)							√	√	√	√			
12	{3,1-0:3.8.1.255,2},	3.8.1	Reactive energy import (+R) T1							√	√	√	√			
13	{3,1-0:3.8.2.255,2},	3.8.2	Reactive energy import (+R) T2							√	√	√	√			
14	{3,1-0:4.8.0.255,2},	4.8.0	Reactive energy export (-R)							√	√	√	√			
15	{3,1-0:4.8.1.255,2},	4.8.1	Reactive energy export (-R) T1							√	√	√	√			
16	{3,1-0:4.8.2.255,2},	4.8.2	Reactive energy export (-R) T2							√	√	√	√			
17	{4,1-0:1.6.0.255,2}	1.6.0	Maximum Demand Register 1 - Active energy import (+P)	√						√	√	√	√			
18	{4,1-0:1.6.1.255,2}	1.6.1	Maximum Demand Register 1 - Active energy import (+P) T1							√	√	√	√			
19	{4,1-0:1.6.2.255,2}	1.6.2	Maximum Demand Register 1 - Active energy import (+P) T2							√	√	√	√			
20	{4,1-0:2.6.0.255,2}	2.6.0	Maximum Demand Register 2 - Active energy export (-P)	√						√	√	√	√			
21	{4,1-0:2.6.1.255,2}	2.6.1	Maximum Demand Register 2 - Active energy export (-P) T1							√	√	√	√			
22	{4,1-0:2.6.2.255,2}	2.6.2	Maximum Demand Register 2 - Active energy export (-P) T2							√	√	√	√			
23	{3,1-0:1.2.0.255,2},	1.2.0	Cumulative Maximum Demand- Active energy import (+P)							√	√	√	√			
24	{3,1-0:1.2.1.255,2},	1.2.1	Cumulative Maximum Demand- Active energy import (+P) rate 1							√	√	√	√			
25	{3,1-0:1.2.2.255,2},	1.2.2	Cumulative Maximum Demand- Active energy import (+P) rate 2							√	√	√	√			
26	{3,1-0:2.2.0.255,2},	2.2.0	Cumulative Maximum Demand- Active energy export (-P)							√	√	√	√			
27	{3,1-0:2.2.1.255,2},	2.2.1	Cumulative Maximum Demand- Active energy export (-P) rate 1							√	√	√	√			
28	{3,1-0:2.2.2.255,2},	2.2.2	Cumulative Maximum Demand- Active energy export (-P) rate 2							√	√	√	√			
29	{1,0-0:0.1.0.255,2},	0.1.0	Billing period counter							√	√	√	√			
30	{3,1-0:1.7.0.255,2},	1.7.0	Instantaneous active import power (+P)	√						√	√	√	√			
31	{3,1-0:2.7.0.255,2},	2.7.0	Instantaneous active export power (-P)	√						√	√	√	√			
32	{3,1-0:13.24.128.255,2},	13.24.12	Average power factor total current month	√						√	√	√	√			
33	{111,0-0:19.0.0.255,5},	19.0.0	*Available credit	√						√	√	√	√			

\*Available credit: this item will not appear when meter in post-payment mode, when meter is switched to prepayment mode, it will be automatically added to the scroll list.

The default display objects for manual scroll mode are described as follows:

index	Logical name	obis	Description	S	P	P	D	C	L	V	C	T	H	V	C	T
1	{1,0-0:96.128.0.255,2}, /		Display all segment	√	√	√	√	√	√	√	√	√	√	√	√	√
2	{1,1-0:0.9.1.255,2},	0.9.1	local time	√	√	√	√	√	√	√	√	√	√	√	√	√
3	{1,1-0:0.9.2.255,2},	0.9.2	local date	√	√	√	√	√	√	√	√	√	√	√	√	√
4	{1,0-0:96.1.0.255,2},	96.1.0	Device ID1, manufacturing number	√	√	√	√	√	√	√	√	√	√	√	√	√
5	{3,1-0:1.8.0.255,2},	1.8.0	Active energy import (+A)	√	√	√	√	√	√	√	√	√	√	√	√	√
6	{3,1-0:1.8.1.255,2},	1.8.1	Active energy import (+A) T1	√	√	√	√	√	√	√	√	√	√	√	√	√
7	{3,1-0:1.8.2.255,2},	1.8.2	Active energy import (+A) T2	√	√	√	√	√	√	√	√	√	√	√	√	√
8	{3,1-0:2.8.0.255,2},	2.8.0	Active energy export (-A)	√	√	√	√	√	√	√	√	√	√	√	√	√
9	{3,1-0:2.8.1.255,2},	2.8.1	Active energy export (-A) T1	√	√	√	√	√	√	√	√	√	√	√	√	√
10	{3,1-0:2.8.2.255,2},	2.8.2	Active energy export (-A) T2	√	√	√	√	√	√	√	√	√	√	√	√	√
11	{3,1-0:3.8.0.255,2},	3.8.0	Reactive energy import (+R)	√	√	√	√	√	√	√	√	√	√	√	√	√
12	{3,1-0:3.8.1.255,2},	3.8.1	Reactive energy import (+R) T1	√	√	√	√	√	√	√	√	√	√	√	√	√
13	{3,1-0:3.8.2.255,2},	3.8.2	Reactive energy import (+R) T2	√	√	√	√	√	√	√	√	√	√	√	√	√
14	{3,1-0:4.8.0.255,2},	4.8.0	Reactive energy export (-R)	√	√	√	√	√	√	√	√	√	√	√	√	√
15	{3,1-0:4.8.1.255,2},	4.8.1	Reactive energy export (-R) T1	√	√	√	√	√	√	√	√	√	√	√	√	√
16	{3,1-0:4.8.2.255,2},	4.8.2	Reactive energy export (-R) T2	√	√	√	√	√	√	√	√	√	√	√	√	√
17	{3,1-0:1.7.0.255,2},	1.7.0	Instantaneous active import power (+P)	√	√	√	√	√	√	√	√	√	√	√	√	√
18	{3,1-0:2.7.0.255,2},	2.7.0	Instantaneous active export power (-P)	√	√	√	√	√	√	√	√	√	√	√	√	√
19	{3,1-0:3.7.0.255,2},	3.7.0	Instantaneous reactive import power (+Q)		√	√	√	√	√	√	√	√	√	√	√	√
20	{3,1-0:4.7.0.255,2},	4.7.0	Instantaneous reactive export power (-Q)		√	√	√	√	√	√	√	√	√	√	√	√
21	{4,1-0:1.6.0.255,2}	1.6.0	Maximum Demand Register 1 - Active energy import (+P)	√	√	√	√	√	√	√	√	√	√	√	√	√
22	{4,1-0:1.6.1.255,2}	1.6.1	Maximum Demand Register 1 - Active energy import (+P) T1	√	√	√	√	√	√	√	√	√	√	√	√	√
23	{4,1-0:1.6.2.255,2}	1.6.2	Maximum Demand Register 1 - Active energy import (+P) T2	√	√	√	√	√	√	√	√	√	√	√	√	√
24	{4,1-0:2.6.0.255,2}	2.6.0	Maximum Demand Register 2 - Active energy export (-P)	√	√	√	√	√	√	√	√	√	√	√	√	√
25	{4,1-0:2.6.1.255,2}	2.6.1	Maximum Demand Register 2 - Active energy export (-P) T1	√	√	√	√	√	√	√	√	√	√	√	√	√
26	{4,1-0:2.6.2.255,2}	2.6.2	Maximum Demand Register 2 - Active energy export (-P) T2	√	√	√	√	√	√	√	√	√	√	√	√	√
27	{4,1-0:3.6.0.255,2}	3.6.0	Maximum Demand Register 1 - Reactive energy import (+Q)		√	√	√	√	√	√	√	√	√	√	√	√
28	{4,1-0:3.6.1.255,2}	3.6.1	Maximum Demand Register 1 - Reactive energy import (+Q) T1		√	√	√	√	√	√	√	√	√	√	√	√
29	{4,1-0:3.6.2.255,2}	3.6.2	Maximum Demand Register 1 - Reactive energy import (+Q) T2		√	√	√	√	√	√	√	√	√	√	√	√
30	{4,1-0:4.6.0.255,2}	4.6.0	Maximum Demand Register 2 - Reactive energy export (-Q)		√	√	√	√	√	√	√	√	√	√	√	√
31	{4,1-0:4.6.1.255,2}	4.6.1	Maximum Demand Register 2 - Reactive energy export (-Q) T1		√	√	√	√	√	√	√	√	√	√	√	√
32	{4,1-0:4.6.2.255,2}	4.6.2	Maximum Demand Register 2 - Reactive energy export (-Q) T2		√	√	√	√	√	√	√	√	√	√	√	√
33	{3,1-0:1.2.0.255,2},	1.2.0	Cumulative Maximum Demand- Active energy import (+P)	√	√	√	√	√	√	√	√	√	√	√	√	√
34	{3,1-0:1.2.1.255,2},	1.2.1	Cumulative Maximum Demand- Active energy import (+P) rate 1	√	√	√	√	√	√	√	√	√	√	√	√	√
35	{3,1-0:1.2.2.255,2},	1.2.2	Cumulative Maximum Demand- Active energy import (+P) rate 2	√	√	√	√	√	√	√	√	√	√	√	√	√
36	{3,1-0:2.2.0.255,2},	2.2.0	Cumulative Maximum Demand- Active energy export (-P)	√	√	√	√	√	√	√	√	√	√	√	√	√

37	{3,1-0:2.2.1.255,2},	2.2.1	Cumulative Maximum Demand- Active energy export (-P) rate 1	√	√	√	√
38	{3,1-0:2.2.2.255,2},	2.2.2	Cumulative Maximum Demand- Active energy export (-P) rate 2	√	√	√	√
39	{3,1-0:32.7.0.255},	32.7.0	Voltage of L1	√	√	√	√
40	{3,1-0:52.7.0.255},	52.7.0	Voltage of L2		√	√	√
41	{3,1-0:72.7.0.255},	72.7.0	Voltage of L3		√	√	√
42	{3,1-0:31.7.0.255},	31.7.0	Current of L1	√	√	√	√
43	{3,1-0:51.7.0.255},	51.7.0	Current of L2		√	√	√
44	{3,1-0:71.7.0.255},	71.7.0	Current of L3		√	√	√
45	{3,1-0:13.7.0.255},	13.7.0	Power factor	√	√	√	√
46	{3,1-0:33.7.0.255},	33.7.0	Power factor of L1		√	√	√
47	{3,1-0:53.7.0.255},	53.7.0	Power factor of L2		√	√	√
48	{3,1-0:73.7.0.255},	73.7.0	Power factor of L3		√	√	√
49	{3,1-0:14.7.0.255},	14.7.0	Frequency	√	√	√	√
50	{1,0-0:96.10.6.255,2},	96.10.6	Instantaneous status word	√	√	√	√
51	{1,0-0:96.10.7.255,2},	96.10.7	Tamper status word	√	√	√	√
52	{1,0-0:0.1.0.255,2},	0.1.0	Billing period counter	√	√	√	√
53	{3,1-0:1.8.0.101,2},	1.8.0.1	Active energy import (+A) for last month	√	√	√	√
54	{3,1-0:2.8.0.101,2},	2.8.0.1	Active energy export (-A) for last month	√	√	√	√
55	{3,1-0:3.8.0.101,2},	3.8.0.1	Reactive energy import (+R) for last month		√	√	√
56	{3,1-0:4.8.0.101,2},	4.8.0.1	Reactive energy export (-R) for last month		√	√	√
57	{4,1-0:1.6.0.101,2}	1.6.0.1	Maximum Demand- Active energy import (+P), for last month	√	√	√	√
58	{4,1-0:1.6.0.101,5}	1.6.0.1	Maximum Demand- Active energy import (+P), data time, for last month	√	√	√	√
59	{4,1-0:2.6.0.101,2}	2.6.0.1	Maximum Demand- Active energy export (-P), for last month	√	√	√	√
60	{4,1-0:2.6.0.101,5}	2.6.0.1	Maximum Demand- Active energy export (-P), data time, for last month	√	√	√	√
61	{4,1-0:3.6.0.101,2}	3.6.0.1	Maximum Demand - Reactive energy import (+Q), for last month		√	√	√
62	{4,1-0:3.6.0.101,5}	3.6.0.1	Maximum Demand - Reactive energy import (+Q), data time, for last month		√	√	√
63	{4,1-0:4.6.0.101,2}	4.6.0.1	Maximum Demand - Reactive energy export (-Q), for last month		√	√	√
64	{4,1-0:4.6.0.101,5}	4.6.0.1	Maximum Demand - Reactive energy export (-Q), data time, for last month		√	√	√
65	{3,1-0:13.24.128.255,2},	13.24.12	Average power factor total current month	√	√	√	√
66	{111,0-0:19.0.0.255,5},	19.0.0	*Available credit	√	√		
67	{3,1-0:141.129.0.255,2},	41.129.0	*Last recharge kWh	√	√		
68	{3,1-0:140.129.5.255,2},	40.129.5	*Monthly consumption energy (import active energy) for last month	√	√		
69	{1,1-0:0.4.2.255},	0.4.2	CT ratio numerator			√	√
70	{1,1-0:0.4.5.255},	0.4.5	CT ratio denominator			√	√
71	{1,1-0:0.4.3.255},	0.4.3	VT ratio numerator				√
72	{1,1-0:0.4.6.255},	0.4.6	VT ratio denominator				√

\*Available credit, \*Last recharge kWh, \*Monthly consumption energy: these items will not appear when meter in post-payment mode, when meter is switched to prepayment mode, it will be automatically added to the scroll list.

The default display objects for power down display mode are described as follows:

index	Logical name	obis	Description	S	PP	D	CL	V	CT	HV	CT
1	{1,0-0:96.1.0.255,2},	96.1.0	Device ID1, manufacturing number	√							
2	{3,1-0:1.8.0.255,2},	1.8.0	Active energy import (+A)-current value	√	√			√		√	
3	{3,1-0:2.8.0.255,2},	2.8.0	Active energy export (-A)-current value	√	√			√		√	
4	{3,1-0:3.8.0.255,2},	3.8.0	Reactive energy import (+R)					√		√	
5	{3,1-0:4.8.0.255,2},	4.8.0	Reactive energy export (-R)					√		√	
6	{4,1-0:1.6.0.255,2}	1.6.0	Maximum Demand Register 1 - Active energy import (+P)	√	√			√		√	
7	{4,1-0:2.6.0.255,2}	2.6.0	Maximum Demand Register 2 - Active energy export (-P)	√	√			√		√	
8	{111,0-0:19.0.0.255,5},	19.0.0	*Available credit	√	√						

\*Available credit: this item will not appear when meter in post-payment mode, when meter is switched to prepayment mode, it will be automatically added to the scroll list.

### 23.3 Tariff scheme

➤ The default tariff scheme for single phase meter:

#### 1. Calendar name

Calendar_name
Cale

#### 2. Season tariff

Season_profile_name	Season_start	Weekly Profile Name
season_1	FF-01-01 FF	week_1

#### 3. Week tariff

Weekly_profile_name	Monday	Tuesday	Wednesday	Thursday	Friday	Saturday	Sunday
week_1	1	1	1	1	1	1	1

#### 4. Day tariff

Day_id	Start-time	Tariff
1	00:00:00	T1

➤ The default tariff scheme for PPDC and CT & VT meter:

#### 1. Calendar name

Calendar_name
cale

#### 2. Season tariff

Season_profile_name	Season_start	Weekly Profile Name
B	FF-03-01 FF	week_2
C	FF-06-01 FF	week_3
D	FF-09-01 FF	week_4
A	FF-12-01 FF	week_1

#### 3. Week tariff

Weekly_profile_name	Monday	Tuesday	Wednesday	Thursday	Friday	Saturday	Sunday
week_1	1	1	1	1	1	1	1
week_2	2	2	2	2	2	2	2
week_3	3	3	3	3	3	3	3
week_4	4	4	4	4	4	4	4

#### 4. Day tariff

Day_id	Start-time	Tariff
1	17:00:00	T1
	21:00:00	T2
2	18:00:00	T1
	22:00:00	T2
3	19:00:00	T1
	23:00:00	T2
4	18:00:00	T1
	22:00:00	T2

#### 23.4 Default parameter

Demand period interval :	1800s
Energy load profile period :	3600s
Daily load profile period:	86400s
Power quality profile period:	3600s
Threshold for voltage sag:	207V, HVCT:57V
Threshold for voltage swell:	253V, CTPT:70V
Threshold for voltage cut:	115V, CTPT:32V
Time threshold for current reverse:	60s
Current threshold for current reverse relay disconnect:	1A
Time threshold for current bypass:	60s
Time threshold for DC injection:	60s
Time threshold for Phase & neutral exchange:	60s
Time threshold for Current without voltage:	60s

More detailed default parameter will be configured in "OBIS LIST FOR METER\_v2.0.xlsx"

Figures:

### 10.4 View

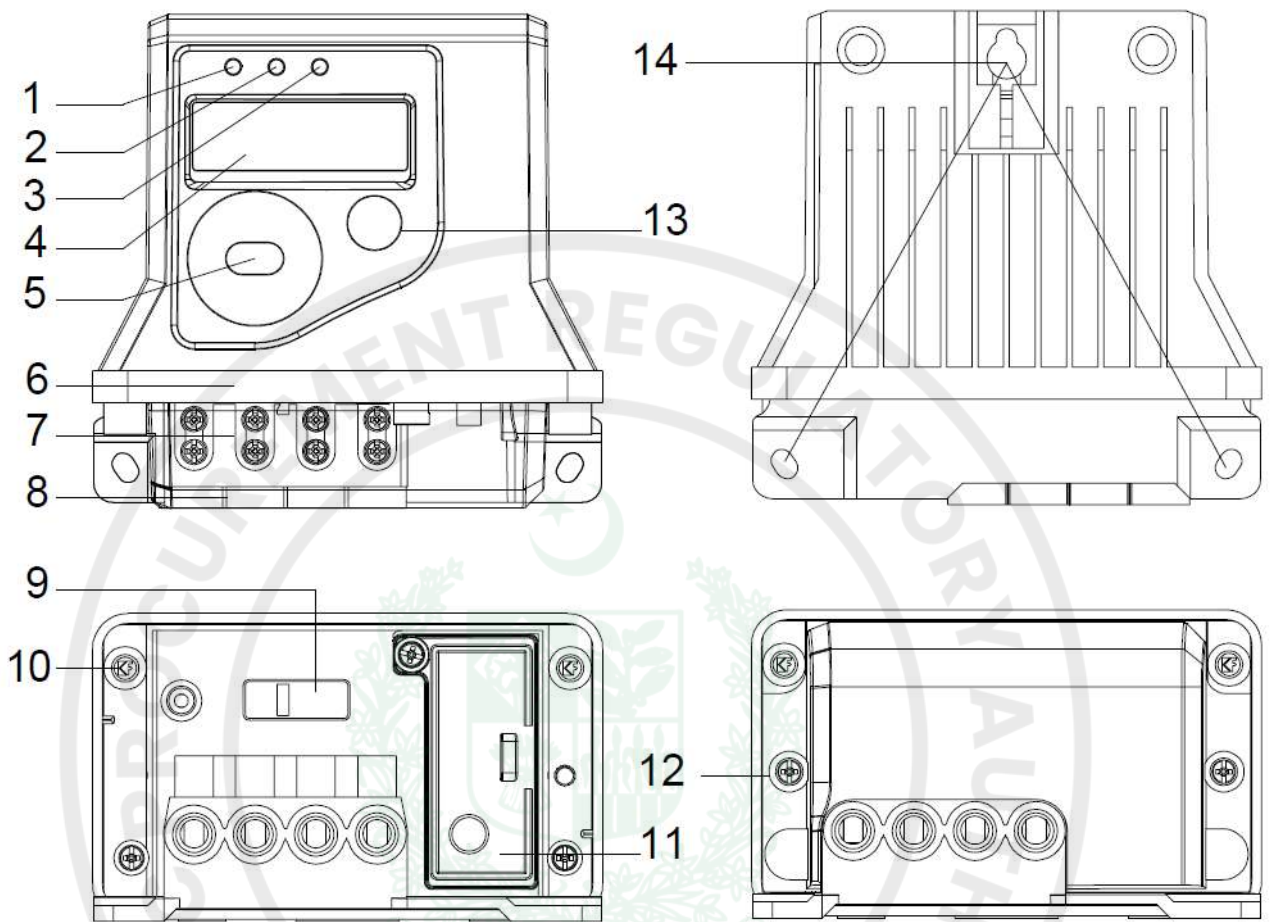

Figure - General view of meter

- |                            |                                   |
|----------------------------|-----------------------------------|
| 1. Active pulse LED        | 8. Terminal cover                 |
| 2. Reactive pulse LED      | 9. External battery               |
| 3. Communication indicator | 10. Metrology cover sealing screw |
| 4. LCD display window      | 11. Communication module          |
| 5. Optical port            | 12. Terminal cover seal           |
| 6. Meter cover             | 13. Display button                |
| 7. Main terminals          | 14. Hook and mount points         |

## Mechanical Features

### Mounting

The meter uses three-point(A base triangle ) mounting which comply with DIN 43857-3. The mounting holes accommodates 5.0 mm mounting screws. Two lower mounting holes are on both sides of the meter bottom part.

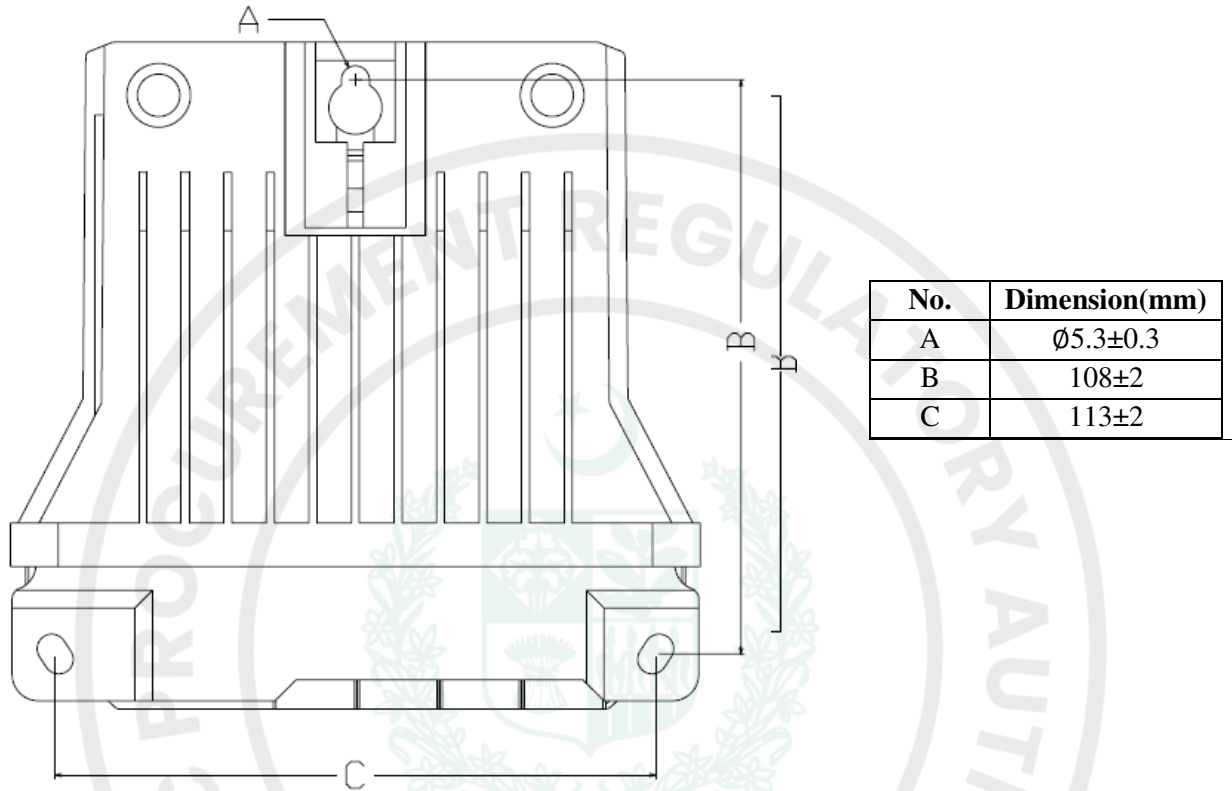

Figure --: Mounting point of meter

## Terminals and Terminal Block

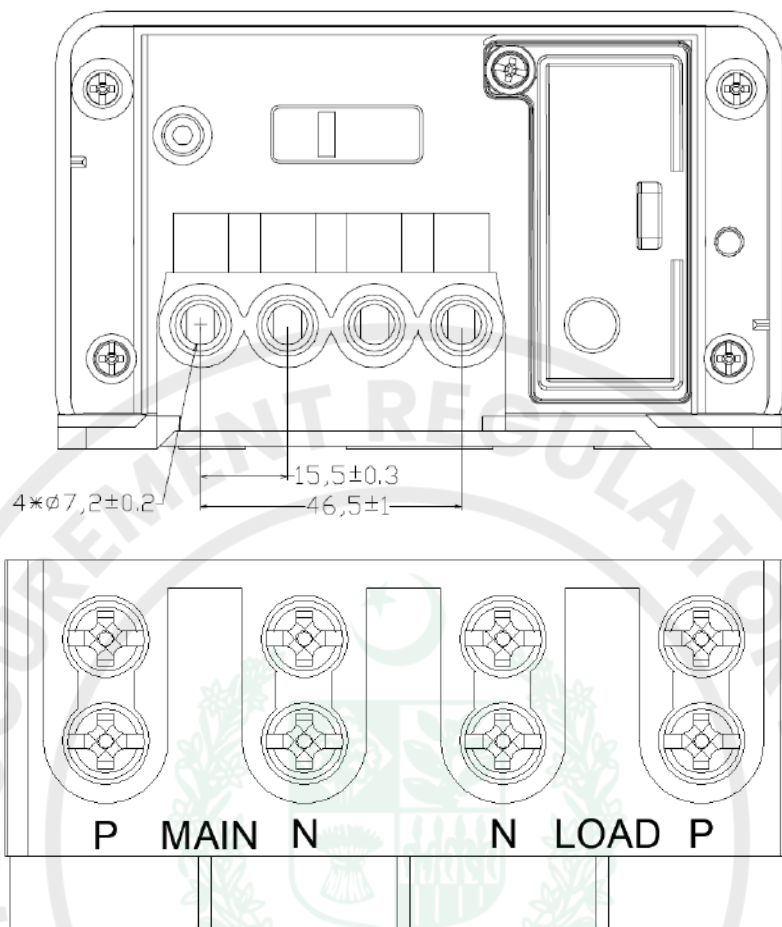

Figure - Dimensions of terminal of Single phase meter

Terminal screw: 7UUIOL;/

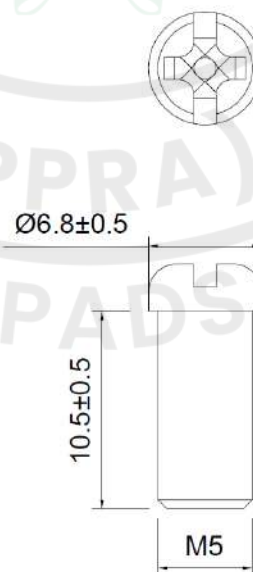

Figure - Dimensions of terminal screw

The terminal block is made of UV-resistance, high impact-resistance and self-extinguishing polycarbonate(PC+20%GF), the color of the terminal block is grey, and the material can pass a glow wire test at  $960^{\circ}\text{C} \pm 10^{\circ}\text{C}$  and duration of application is  $30 \pm 1\text{s}$ .

## External Battery Slot

The meter supports an external battery slot for CR2032 type, which is protected by the terminal cover.

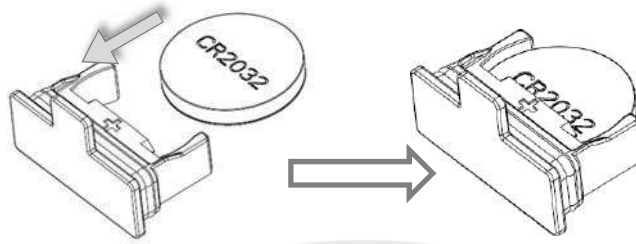
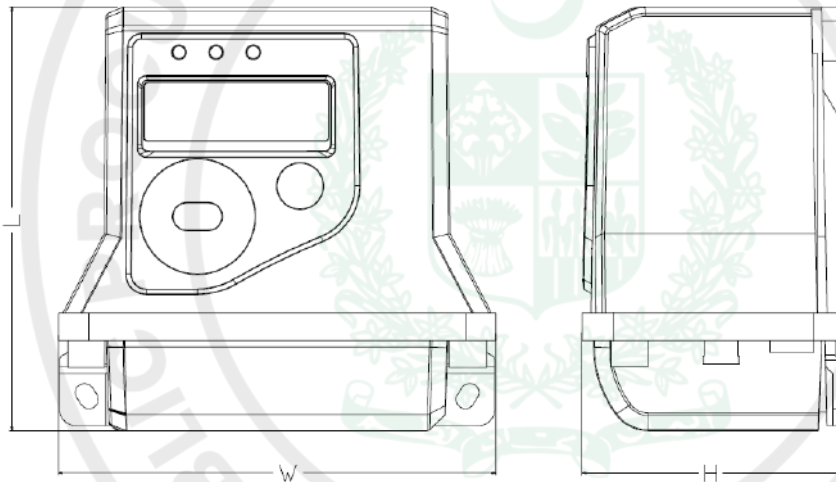

Figure - Battery installation

## Dimensions and Weight

The dimension of meter is (L×W×H) , the weight of meter is  $\leq 1.8\text{Kg}$ .



No.	Dimension
L	126±2
W	130±2
H	78±2

Figure - Dimensions of single phase meter

## Nameplate

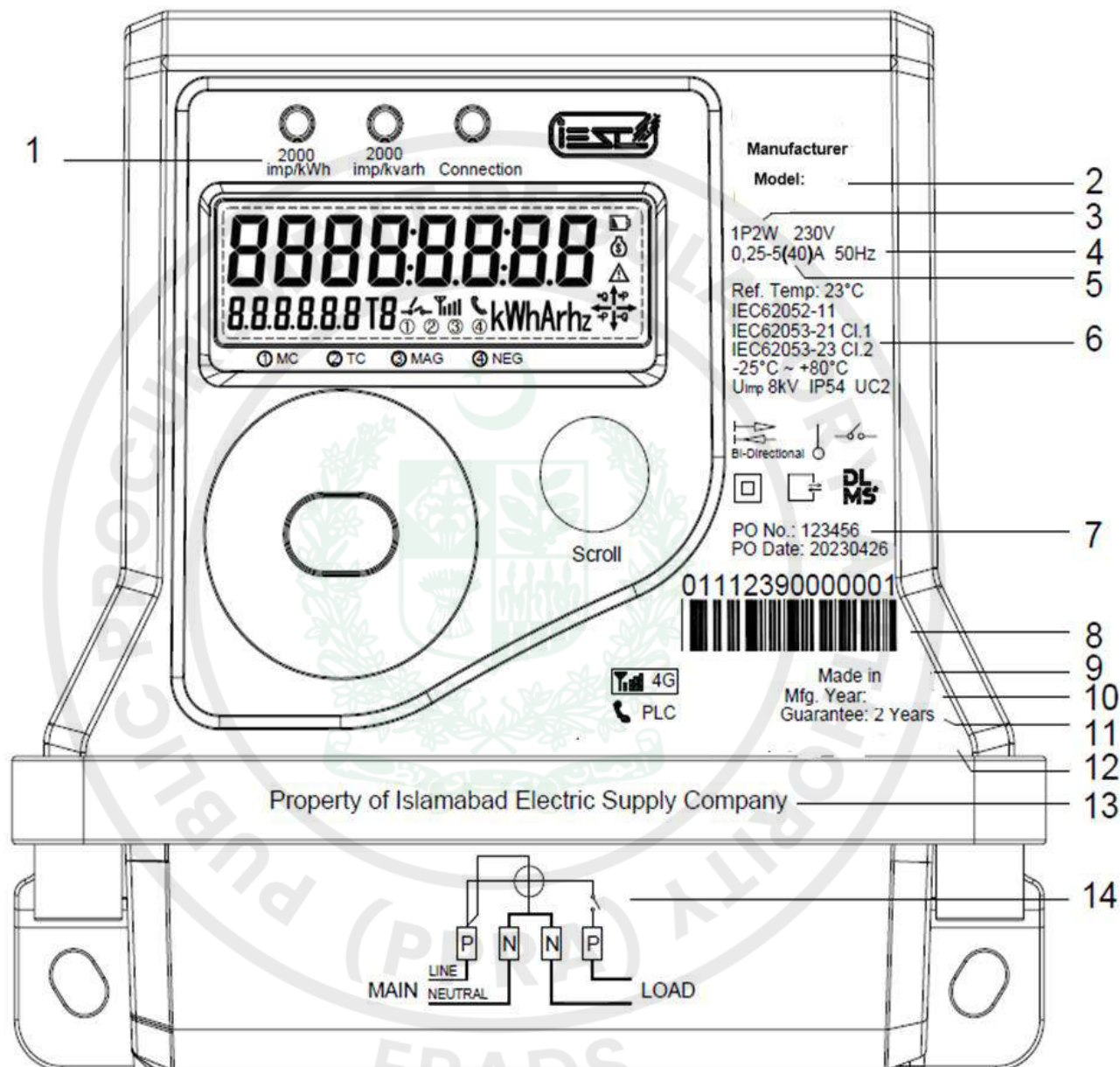

Figure - Marking of single phase meter

- |                                 |                                   |
|---------------------------------|-----------------------------------|
| 1. Meter constant               | 8. Serial number                  |
| 2. Type designation             | 9. Country of manufacture         |
| 3. Number of phases and wires   | 10. Month and Year of manufacture |
| 4. Rated frequency              | 11. Guarantee period              |
| 5. Current range, rated voltage | 12. Manufacturer's name           |
| 6. Class index                  | 13. Property of utility           |
| 7. Purchase Order No. & date    | 14. Connection diagram            |

## Wiring Diagram

A wiring diagram is engraved on the terminal cover.

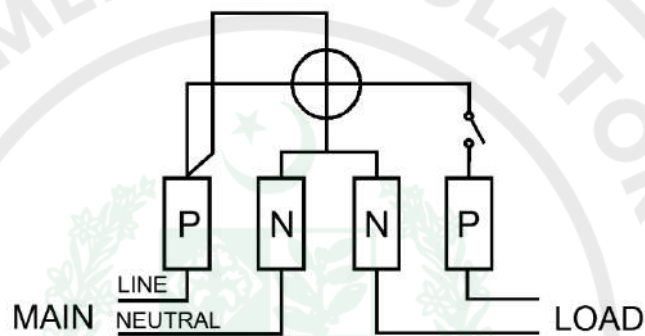

Figure - Wiring diagram of single phase meter

## Sealing of Meter

The meter has five security seals:

- i. One seal is for communication module sealing
- ii. Two seals are for terminal cover sealing
- iii. Two seals (Metrology sealing) are for the meter cover

It is impossible to touch the meter metrology part unless physically and transparently destroy the metrology seals and the meter enclosure.

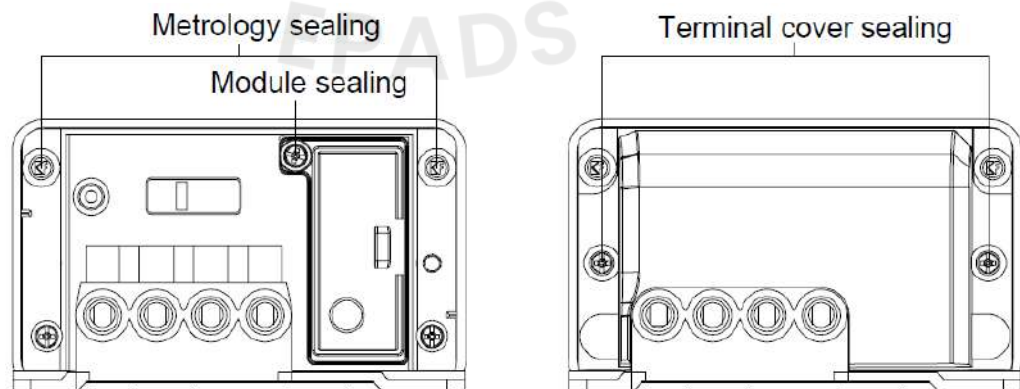





















Figure - Sealing of single phase meter

### LCD Screen of Meter



Figure - Diagram of LCD screen

Number/Symbol	Description
 (first row)	Display main information of meter, normally for energy registers.
 (left of second row)	OBIS Code
	ON: Meter in prepayment mode: OFF: meter in post-payment mode Blink: low credit warning when meter in prepayment mode
M G	not used
kWhArhz	The units include: A, V, kWh, kvarh, kvah, kW, kvar, kva, Hz, h, W, var, va, Wh, varh, vah..

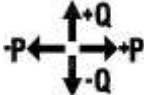
	<p>Phase indicators:-  <b>On:</b> Normal voltage  <b>Off:</b> Missing voltage  <b>Blink:</b> Current reversal</p>
	<p>Tariff indicator.</p>
	<p>Relay status:</p>
	<p>  ON: relay disconnected   blink: ready for reconnect   ON: relay connected         </p>
	<p> <b>On:</b> PLC module is plugged on the meter  <b>Off:</b> PLC module is not detected.         </p>
	<p> <b>On:</b> 4G/2G module is plugged on the meter  <b>Off:</b> 4G/2G module is not detected.         </p>
	<p>Displays the 4G/2G signal strength:</p> <p>  RSSI &lt; -120 dBm   -120 dBm &lt;= RSSI &lt; -100 dBm   -100 dBm &lt;= RSSI &lt; -90 dBm   -90 dBm &lt;= RSSI &lt; -80 dBm   RSSI &gt;= -80 dBm         </p>
	<p> <b>Low battery indicator:</b>  <b>Blink:</b> Battery is low.  <b>Off:</b> Battery is normal.         </p>
	<p>Self-diagnostic error, refers to chapter 5.11.1 self-diagnostics</p>
	<p>Indicate quadrant of power</p>

	<p>Four small circles are used to indicate four statuses/modes are activated or not. The status/modes are label printed on the meter cover. The status/mode is activated when the above relative circles is lighted.</p> <ul style="list-style-type: none"><li>① : Meter cover open, which needs to be cleared via command.</li><li>② : Terminal cover open, which needs to be cleared via command.</li><li>③ : Strong magnetic field, which needs to be cleared via command.</li><li>④ : Negative consumption flag, when the meter detects the reverse energy, it will be set, and it can't be cleared until a clear command is received or a billing reset is executed.</li></ul>
---	---



### Schedule of Technical Data

<b>General</b>		<b>Remarks</b>
1	Bidder's Name & Address	
2	Manufacturer's Name	
3	GPS Coordinates of Office Location	
4	Manufacturer's Manufacturing Address	
5	GPS Coordinates of Manufacturing Location	
6	Manufacturing Experience (Years)	
<b>ENERGY METERS</b>		
1	Model No.	
2	Type	
3	Current (Amp)	
I.	Minimum Starting Current at (mA) at Reference Voltage & Frequency	
II.	Basic	
III.	Maximum	
IV.	Overload Capacity (Amp)	
4	Voltage (Volts)	
I.	Nominal	
II.	Minimum	
III.	Maximum	
5	Accuracy Class	
I.	kWh	
II.	kVARh	
III.	kW	
6	No. of Elements (Nos.)	
7	Power Loss in Voltage Circuit (Max.)	
8	Power Loss in Current Circuit (Max.)	
9	Power Loss in Communication Module (Max.)	
10	Encapsulation Details	
I.	Current Sensor (Type)	
II.	Class of Insulation	
11	Max. Current that Energy Meter can withstand during short circuit for 0.5sec.	
12	Dielectric Strength	
I.	Impulse Voltage Test	
II.	A.C Voltage Test	
13	Insulation Resistance of Energy Meter	
<b>14</b>	<b>Material(s) of</b>	
I.	Case Cover Base Standard(s) to which material(s) are complies with	
II.	Security Box Standard(s) to which material(s) are complies with -	

Title:	Shipment Specification	Ver.	1.3	Page:	126 of 154
--------	------------------------	------	-----	-------	------------

III.	Terminal Block Standard(s) to which material(s) are complies with	
<b>15</b>	<b>TERMINALS</b>	
I.	No. of Terminals	
II.	Fixed Terminal Type	
III.	Terminal Material	
IV.	Moving Terminal and Screw Standard(s) to which material(s) are complies with	
16	<b>Printed Circuit Board</b> <b>(All the above shall be indicated on drawing to be supplied with the bid)</b>	
17	<b>Temperature rise of meter</b>	
18	<b>Center to center clearance between different phases</b>	
I.	Creepage Distance	
II.	Clearance	
19	<b>Whether the Energy Meter is compliant to the reference standards for testing mentioned in Annex-C of the specs</b>	
20	<b>Whether the Energy Meter has the following characteristics</b>	
I.	Basic data recording and storage: (as per clause 8 of the spec.), give details	
II.	Back-up Battery (as per clause 8.3 of the spec.), give details	
III.	Security Features, Events recording and Diagnostics: (as per clause 7.2 of the spec.), give details	
IV.	Display (as per clause 8.6 of the spec.), give details	
V.	Energy Meter Programming, Software and Security: (as per clause 10 of the spec.) give details.	
21	<b>Operating ambient temperature range</b>	
I.	Specified Operating Range	
II.	Limit Range of Operation (Extreme Condition)	
III.	Limit Range for storage and Transport	
22	<b>Size and No. of Digit of LCD Display</b>	
23	<b>Whether Energy Meter have the upgradeability option for AMI.</b>	
24	<b>What is the sampling rate</b>	
25	<b>IP Class of Energy Meter</b>	
26	<b>No. of Digits for following Features</b>	
I.	kWh	
II.	kVArh	
III.	Demand kW	
IV.	Cumulative kW	
V.	No. of Reset Digits	
27	<b>What values/readings are controlled through resetting device?</b>	
28	<b>Detail of resetting device with sealing arrangement (give drawing)</b>	
29	<b>Min. No. of tariff/rates for which the tariff register can be programmed for</b>	

I.	KWh	
II.	KVARh	
III.	KW	
30	Effect of external magnetic field as per IEC 62053-21 Clause 8.2.4	
31	Effect of Radio frequency signals	
32	Effect of Influence of DC and Even Harmonics as per IEC 62053-21, IEC 62053-23	
33	Effect of other Influence Quantities as per IECs	
34	Type of Meter Memory	
35	Storage capacity of memory	
36	Time to retain the memory	
37	In case of error in register Which types of checks are Provided which automatically Identifies the error	
38	<b>Meter Clock:</b>	
I.	Source of operation of Built in clock	
II.	Effect of variation of Frequency of source	
III.	Source of operation of Clock in case of power outage	
IV.	If battery is used what is the life of battery	
V.	Period/life for which the battery can supply power continuously to check and register prior to its discharge below 25%	
VI.	No. of programmable dates to account for holidays and Weekends	
39	The Meter Programming/Reading Software is DOS or Windows	
40	Name/ Rating Plate; Detail of information given on Name Plate	
41	<b>Attachments Whether the following material has been attached</b>	
I.	Accuracy Curves	
II.	Drawings of meter showing dimensions, mounting details etc	
42	Bidders/manufacturers have to supply all relevant drawings & technical literature duly marked	
43	Details of the deviations of the offered equipment from specification (use separate sheet if required)	
44	Details of Test Report	

EPADS

## **Annex 5 Communication Module Specification**

### **5.1 4G/2G Communication Module**

#### **Overview**

This product adopts 4G/2G wireless transmission network as communication media to fulfill reading, monitoring and controlling on meters. It supports the HES to collect the data of meters, to monitor the power quality and working status of meters, and to remotely control the working of them. The module is equipped with SIM Card, UART interface and power supply. A unify-designed communication module support both single phase and three phase meters, easily maintenance, with plug & play technology, can install or replace module without power off.

#### **Abbreviation**

4G	The 4 <sup>th</sup> generation mobile communication technology
2G	2-Generation wireless telephone technology
UART	Universal Asynchronous Receiver/Transmitter
TRP	Total Radiated Power
TIS	Total Isotropic Sensitivity
SWR	Voltage Standing Wave Ratio

## Main Technical Features

### Wireless Transmission Features

<b>General Function</b>	<b>Performance &amp; Availability</b>	<ul style="list-style-type: none"> <li>- FDD-LTE CAT1: B1(2100 MHz)/B3(1800 MHz)/B5(850 MHz)/B8(900 MHz)</li> <li>- 2G: 900/1800 MHz</li> <li>- Control via AT commands</li> <li>- Operation temperature: -25°C to +80°C</li> <li>- Max transmit power:            LTE CAT1 B1/B3/B5/B8: 23±2.7dBm            2G 900M/1800M: 33dBm/30±2dBm</li> <li>- Support reconnection behavior after detecting an unexpected interrupted communication session.</li> </ul>
	<b>Modulation</b>	LTE CAT1: QPSK/16QAM 2G: GMSK
	<b>Data rate</b>	LTE CAT1: 10Mbps 2G: 85.6Kbps
	<b>Roaming</b>	Support national roaming between 4G/2G networks of different national telecom providers.
	<b>SIM</b>	Support 2FF SIM card. Support IMEI lock of the USIM card.
	<b>Indications of 4G/2G signal strength</b>	Indicate 4G/2G signal strength (RSSI) in a minimum of 4 separate levels. Refer to LCD display. RSRP, RSRQ, RSSI and SINR value are readable.
	<b>Antenna</b>	Default built-in antenna, the modem module can be replaced with another version that supports external antennas. built-in antenna Peak Gain: 820-970MHz 3.89 dBi    1710-2170MHz 3.56 dBi
<b>Access and connection</b>	<b>Wake-up</b>	Support fully qualified domain names. Receive and store the IPv4 or IPv6 addresses of the primary and secondary address when establishing a PDP context based on the DHCP protocol. Support data push.
	<b>Authentication and security</b>	Changeable APN/password Support RADIUS authentication using PAP or CHAP Network access information is not saved on the SIM cards Communication settings to be remotely configurable
	<b>Assign IP address</b>	4G/2G module support both dynamic IP address assignment and static IP address

Table - 1 Description of wireless transmission technical features

### Physical Features

The dimension of 4G/2G module is(L×W×H) 97.2mm×64.6mm×36.6mm(±0.2mm).

The module has 15.0V±5% (DC) power supply coming from the meter with a maximum pulse current consumption of 850mA. Standby power consumption is less than 30mA, and power consumption is less than 200mA when communicating.

The module communication interface to the Meter using UART interface.

The module is equipped with a SIM card holder, supporting 1.8V/3V USIM card.

## Mechanical General View

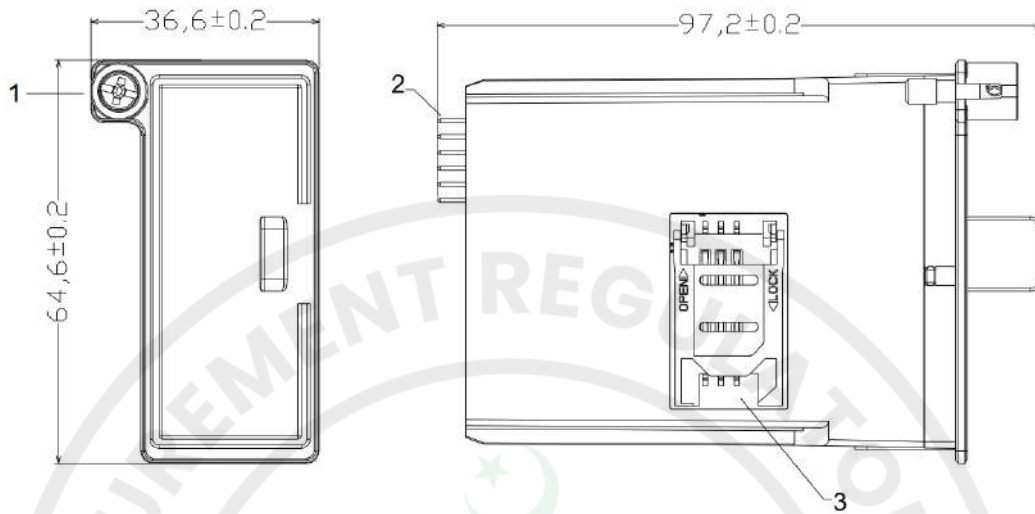
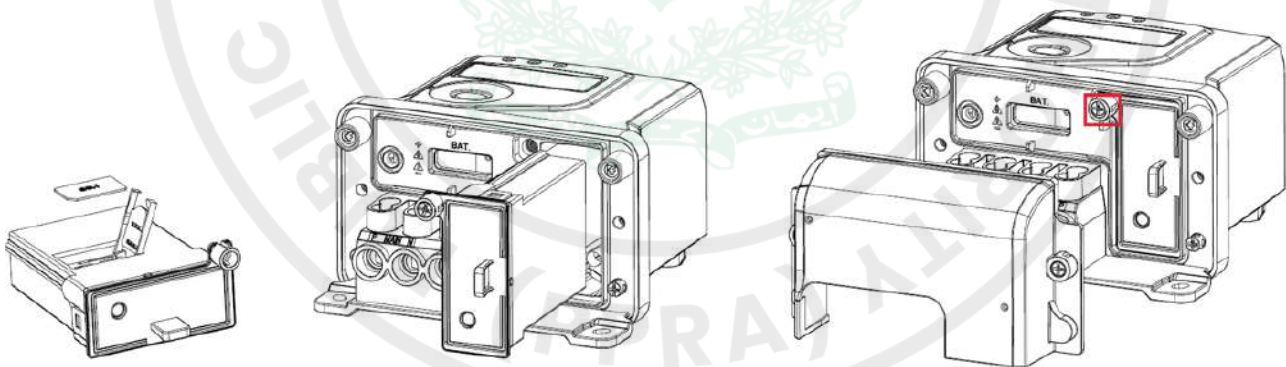

Figure - 1 General view of 4G/2G module

1. 4G/2G module sealing screw
2. DC power supply and UART interface
3. SIM card socket

### Mounting

The module is installed in a plastic housing and mounted inside the meter with sealing screw.



#### Step1. Insert SIM card

#### 4G/2G Module Communication Status Display

One green-color LED on the meter indicates the 4G/2G module communication status:

LED Status	Indicating Status
Off	No communication module is plugged or communication module fails
Blink 0.5s on, 3s off	No SIM card insert or SIM card cannot be detected
Blink 1s on, 0.2s off	Module network registering
Blink 1s on, 3s off	Module network registration is rejected
Blink 1s on, 1s off	Module is registered succeed, TCP connection is ongoing
Blink 0.2s on, 0.2s off	Remote communication is ongoing
On	Meter is registered succeed, no remote communication is ongoing

Table - 2 Communication status of 4G/2G module

The wireless signal strength of 4G /2G module can be easily readout through the meter LCD.







Number/Symbol	Description
	On: 4G/2G module is inserted in the meter Off: 4G/2G module is not detected.
	Displays the 4G/2G signal strength:  RSSI < -120 dBm (Very poor Signal)  -120 dBm ≤ RSSI < -100 dBm (Poor Signal)  -100 dBm ≤ RSSI < -90 dBm (Bad signal)  -90 dBm ≤ RSSI < -80 dBm (Good signal)  RSSI ≥ -80 dBm (Excellent signal)

Table - 3 Description of wireless signal strength on meter LCD screen

### Firmware Upgrade

The communication module support to upgrade firmware remotely. FOTA (Firmware Over-The-Air) upgrade mode is adopted. In-flight download software upgrade of module refers to providing firmware upgrade services for modules through cloud upgrade technology. Users can obtain intelligent terminal system upgrade packages on demand and perform cloud upgrade through FOTA. Complete system repair and optimization.

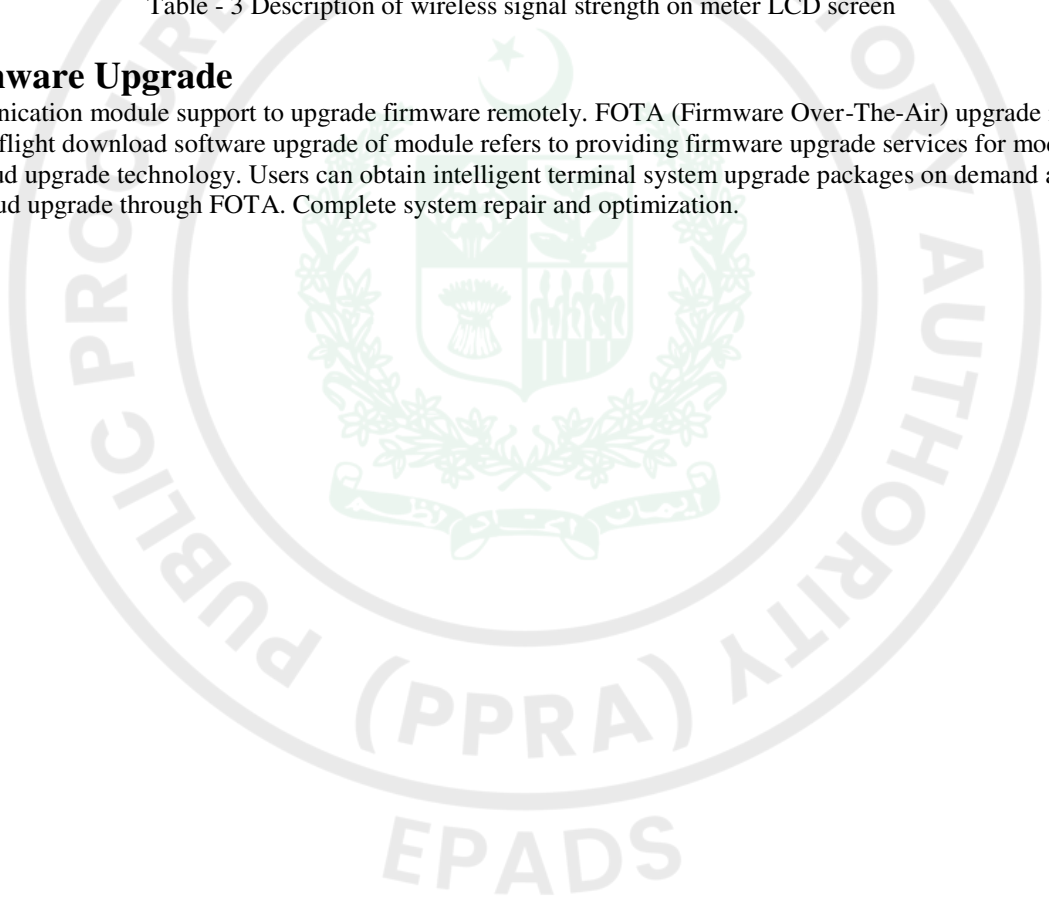

## SIM Card

### SIM Card Technical Features

The SIM card provided by the operator needs to meet the following requirements, to get the best performance.

<b>Temperature</b>	Operation temperature: -25°C to +80°C
<b>Dimensions</b>	Plug-in Card(2FF): length 25mm, width 15mm, thickness <b>0.8±0.08mm</b> Do not use Micro or Nano SIM card
<b>Voltage</b>	3.0V and 1.8V
<b>Reliability</b>	Industrial grade card Meet 1000 hours of dual 85 testing (85°C and 85% humidity)

Table - 4 SIM Card Technical Features

## External antenna module

When the signal in the area where the meter is located in poor signal area and the build-in antenna module signal cannot communicate, supplier shall provide an external antenna module to replace the build-in antenna module for the meter.

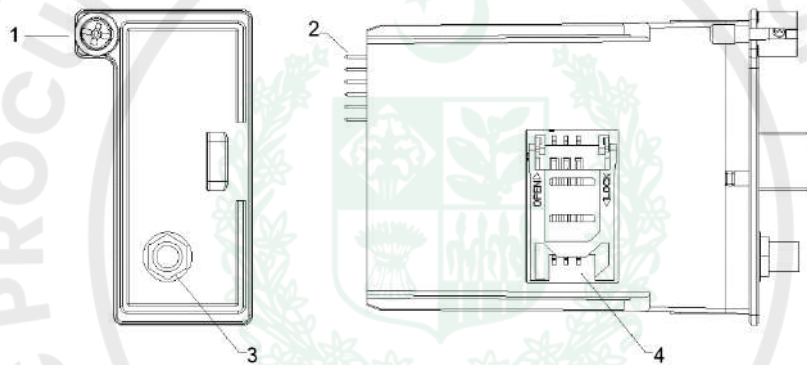

Figure - 4 General view of 4G/2G external antenna module

1. 4G/2G module sealing screw
2. DC power supply and UART interface
3. SMA external antenna interface
4. SIM card socket

There have a SMA pre-cut hole design on meter terminal cover, the hole with a pre-cut on the terminal cover as a default configuration, if the meter with PLC module, and 4G/2G modules with built-in antennas, the pre-cut hole will be kept.

In case of a external antenna 4/2G module is equipped, the pre-cut hole on the terminal cover should be removed for external antenna installation.

For single phase meter:

- Step 1. Insert SIM card      Step 2. Insert module to meter

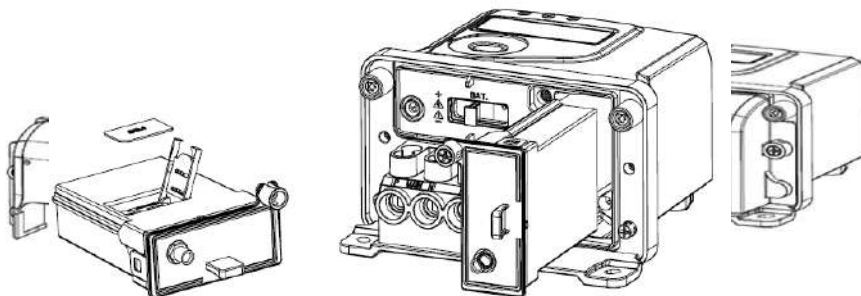

Step 3. Connect external antenna through terminal cover Step 4. Install the module seal, and install terminal cover and put the rubber plug into the hole on terminal cover

Figure -5 External antenna installation for Single-phase meter



## Reference Standards

### 1. Electrical Standards

No.	Standard No.	Title
1	IEC 62054-21	Electricity metering equipment(a.c.)-General requirements, tests and test conditions-Part 21: Tariff and load control equipment
2	EN55032:2015/A1:2020	Electromagnetic compatibility of multimedia equipment - Emission Requirements
3	EN55035:2017	Electromagnetic compatibility of multimedia equipment - Immunity requirements
4	IEC 60068-2-1:2007	Environmental testing-Part 2-1: Tests-Test A: Cold
5	IEC 60068-2-2:2007	Environmental testing-Part 2-2: Tests-Test B: Dry heat
6	IEC 60529 2013	Degrees of protection provided by enclosures (IP Code)
7	IEC 62052-31 2015	Electricity metering equipment (AC) General requirements tests and test conditions Part 31 Product safety

### 2. 4/2G module Standards

No.	Standard No.	Title
1	3GPP Release 13 LTE Cat.1bis	-
2	ETSI TS 102 221	Smart Cards; UICC-Terminal interface; Physical and logical characteristics (Release 15)

## Module Configuration List

Module supports configurations of the following parameters for network functions via DLMS protocol.

Item	Class	Obis Code	Attri	Description
Modem setup	45	0-0:25.4.0.255	2	Configuration for APN
			3	Configuration for Pin Code
PPP setup	44	0-0:25.3.0.255	5	Configuration for PPP_authentication, include username and password
TCP-UDP setup	41	0-0:25.0.0.255	6	Configuration for TCP Inactivity timer, if no TCP traffic and the timer is timeout, TCP connection for reading is released.
Auto connect (For push)	29	0-0:2.1.0.255	3	Configuration for Push retry times
			4	Configuration for Push retry interval
			6	Configuration for Push address, support both IP and domain name
FOTA	1	0-1:94.31.22.255	2	Configuration for FOTA URL
	9	0-2:10.0.1.255	2	Configuration for FOTA enable

APN: It's a network access technology and APN is a parameter that must be configured when accessing the Internet through a module.

Title:	Shipment Specification	Ver.	1.3	Page:	135 of 154
--------	------------------------	------	-----	-------	------------

PinCode: Personal Identification Number, The PIN code of the SIM card is a security measure to protect the SIM card and prevent others from stealing the SIM card. Usually, the PIN code is default disabled. If the PIN code is enabled, a four digits PIN code is needed for inputting for verification after SIM card has power supply first time.

PinCode is enabled or disabled, it depends on the SIM card suppliers.



## 5.2 4G & 2G Communication Module

### Overview

This product adopts 4G/2G wireless transmission network as communication media to fulfill reading, monitoring and controlling on meters. It supports the HES to collect the data of meters, to monitor the power quality and working status of meters, and to remotely control the working of them. The module is equipped with SIM Card, UART interface and power supply. A unify-designed communication module support both single phase and three phase meters, easily maintenance, with plug & play technology, can install or replace module without power off.

### Abbreviation

4G	The 4 <sup>th</sup> generation mobile communication technology
2G	2-Generation wireless telephone technology
UART	Universal Asynchronous Receiver/Transmitter
TRP	Total Radiated Power
TIS	Total Isotropic Sensitivity
SWR	Voltage Standing Wave Ratio

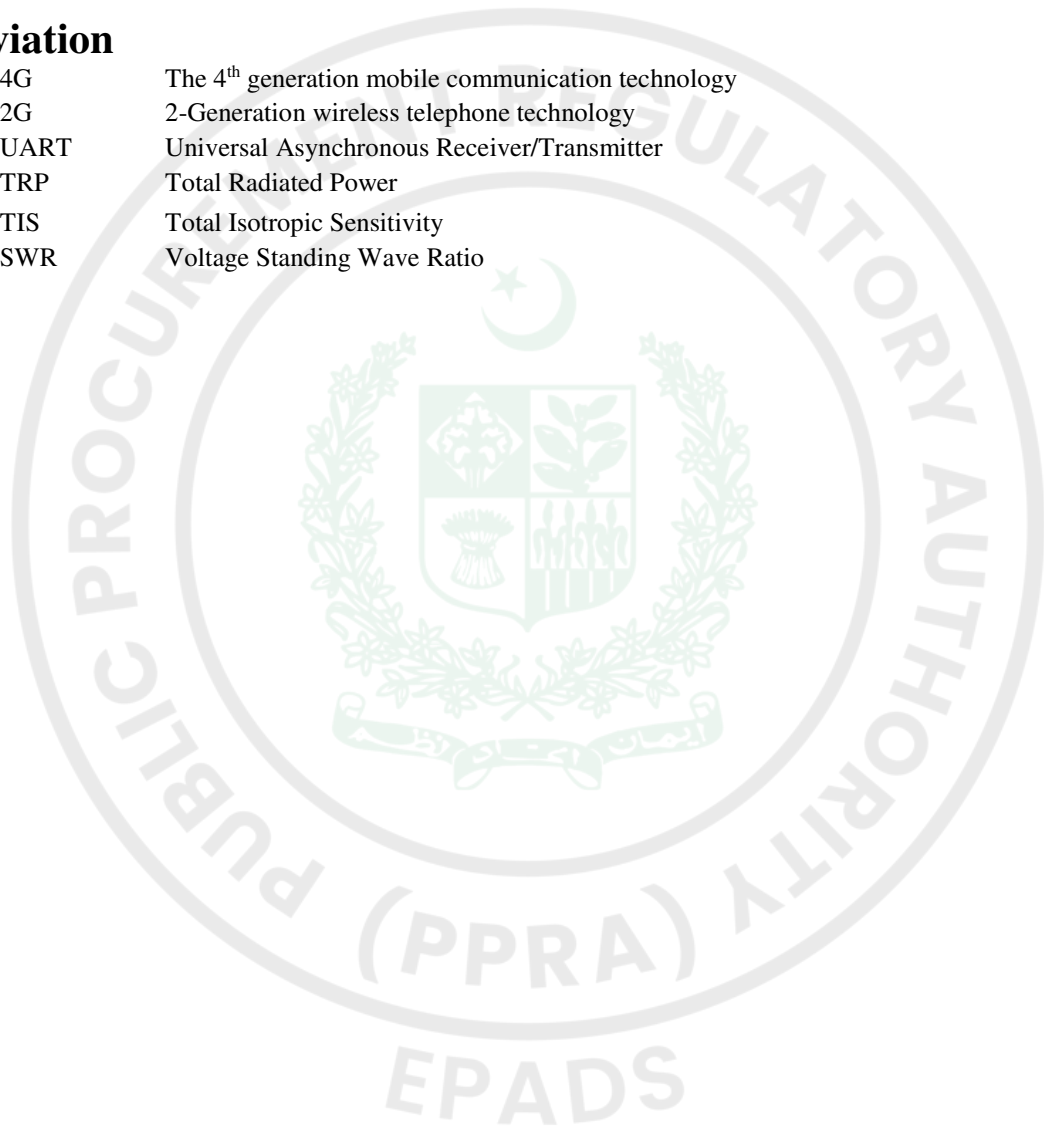

## Main Technical Features

### Wireless Transmission Features

<b>General Function</b>	<b>Performance &amp; Availability</b>	<ul style="list-style-type: none"> <li>- FDD-LTE CAT1: B1(2100 MHz)/B3(1800 MHz)/B5(850 MHz)/B8(900 MHz)</li> <li>- 2G: 900/1800 MHz</li> <li>- Control via AT commands</li> <li>- Operation temperature: -25°C to +80°C</li> <li>- Max transmit power:  LTE CAT1 B1/B3/B5/B8: 23±2.7dBm  2G 900M/1800M: 33dBm/30±2dBm</li> <li>- Support reconnection behavior after detecting an unexpected interrupted communication session.</li> </ul>
	<b>Modulation</b>	LTE CAT1: QPSK/16QAM 2G: GMSK
	<b>Date rate</b>	LTE CAT1: 10Mbps 2G: 85.6Kbps
	<b>Roaming</b>	Support national roaming between 4G/2G networks of different national telecom providers.
	<b>SIM</b>	Support 2FF SIM card. Support IMEI lock of the USIM card.
	<b>Indications of 4G/2G signal strength</b>	Indicate 4G/2G signal strength (RSSI) in a minimum of 4 separate levels. Refer to LCD display. RSRP, RSRQ, RSSI and SINR value are readable.
	<b>Antenna</b>	Default built-in antenna, the modem module can be replaced with another version that supports external antennas. built-in antenna Peak Gain: 820-970MHz 3.89 dBi    1710-2170MHz 3.56 dBi
<b>Access and connection</b>	<b>Wake-up</b>	Support fully qualified domain names. Receive and store the IPv4 or IPv6 addresses of the primary and secondary address when establishing a PDP context based on the DHCP protocol. Support data push.
	<b>Authentication and security</b>	Changeable APN/password Support RADIUS authentication using PAP or CHAP Network access information is not saved on the SIM cards Communication settings to be remotely configurable
	<b>Assign IP address</b>	4G/2G module support both dynamic IP address assignment and static IP address

Table - 1 Description of wireless transmission technical features

### Physical Features

The dimension of 4G/2G module is(L×W×H) 97.2mm×64.6mm×36.6mm(±0.2mm).

The module has 15.0V±5% (DC) power supply coming from the meter with a maximum pulse current consumption of 850mA. Standby power consumption is less than 30mA, and power consumption is less than 200mA when communicating.

The module communication interface to the Meter using UART interface.

The module is equipped with a SIM card holder, supporting 1.8V/3V USIM card.

## Mechanical General View

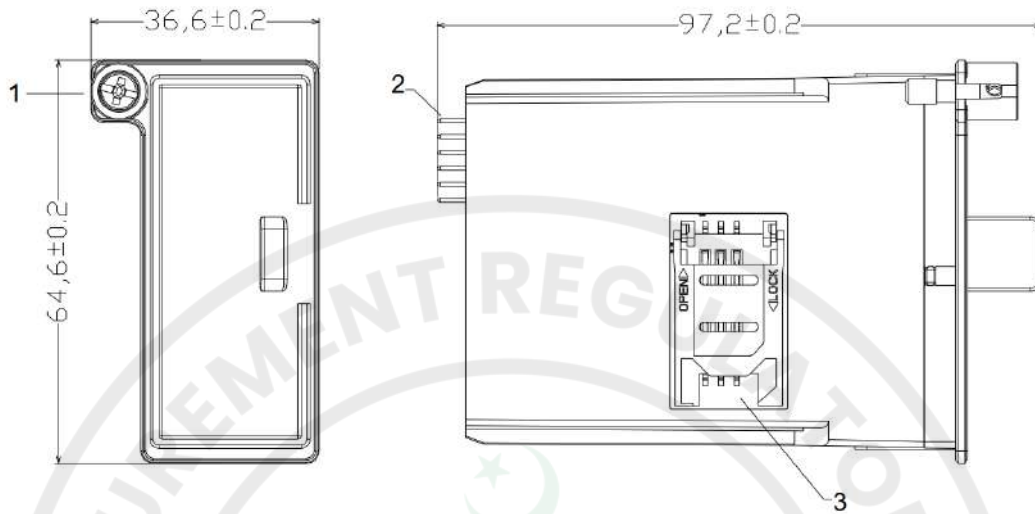
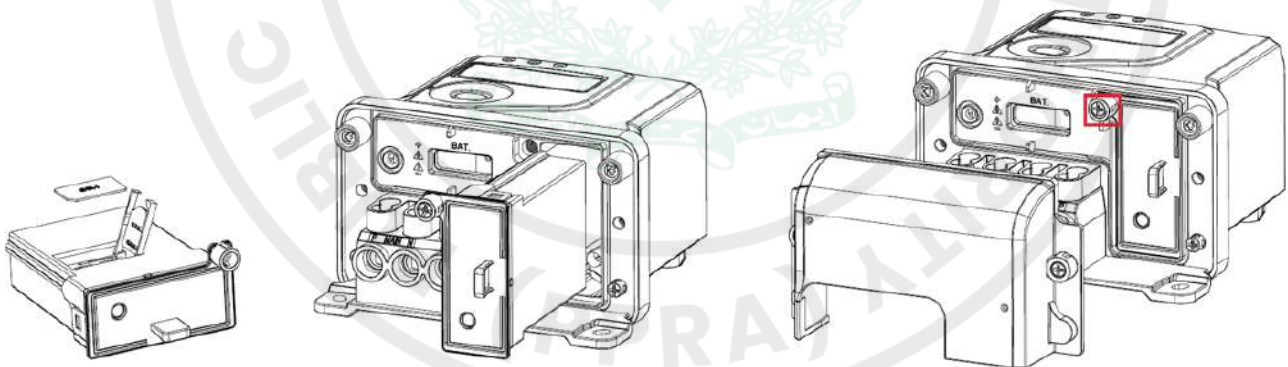

Figure - 1 General view of 4G/2G module

1. 4G/2G module sealing screw
2. DC power supply and UART interface
3. SIM card socket

### Mounting

The module is installed in a plastic housing and mounted inside the meter with sealing screw.



#### Step1. Insert SIM card

#### 4G/2G Module Communication Status Display

One green-color LED on the meter indicates the 4G/2G module communication status:

LED Status	Indicating Status
Off	No communication module is plugged or communication module fails
Blink 0.5s on, 3s off	No SIM card insert or SIM card cannot be detected
Blink 1s on, 0.2s off	Module network registering
Blink 1s on, 3s off	Module network registration is rejected
Blink 1s on, 1s off	Module is registered succeed, TCP connection is ongoing
Blink 0.2s on, 0.2s off	Remote communication is ongoing
On	Meter is registered succeed, no remote communication is ongoing

Table - 2 Communication status of 4G/2G module

Title:	Shipment Specification	Ver.	1.3	Page:	139 of 154
--------	------------------------	------	-----	-------	------------

## 5.3 Shipment file

### 1 Overview

This document specifies the shipment format for importing meters and DCUs into the system. As required in the SOR, the device should be imported into Device Park System, and these information will be synchronized to MDMS and HES through interface.

#### 1.1 Shipment File Description

The XML file records all necessary device information. Users can import excel files to the Device Park System.

#### 1.2 Supported Device

- Meter
  - 1) Single Phase Meter
  - 2) Three Phase Meter
  - 3) CT Meter
  - 4) CT/VT Meter
- DCU

### 2 Shipment file Generation and Delivery

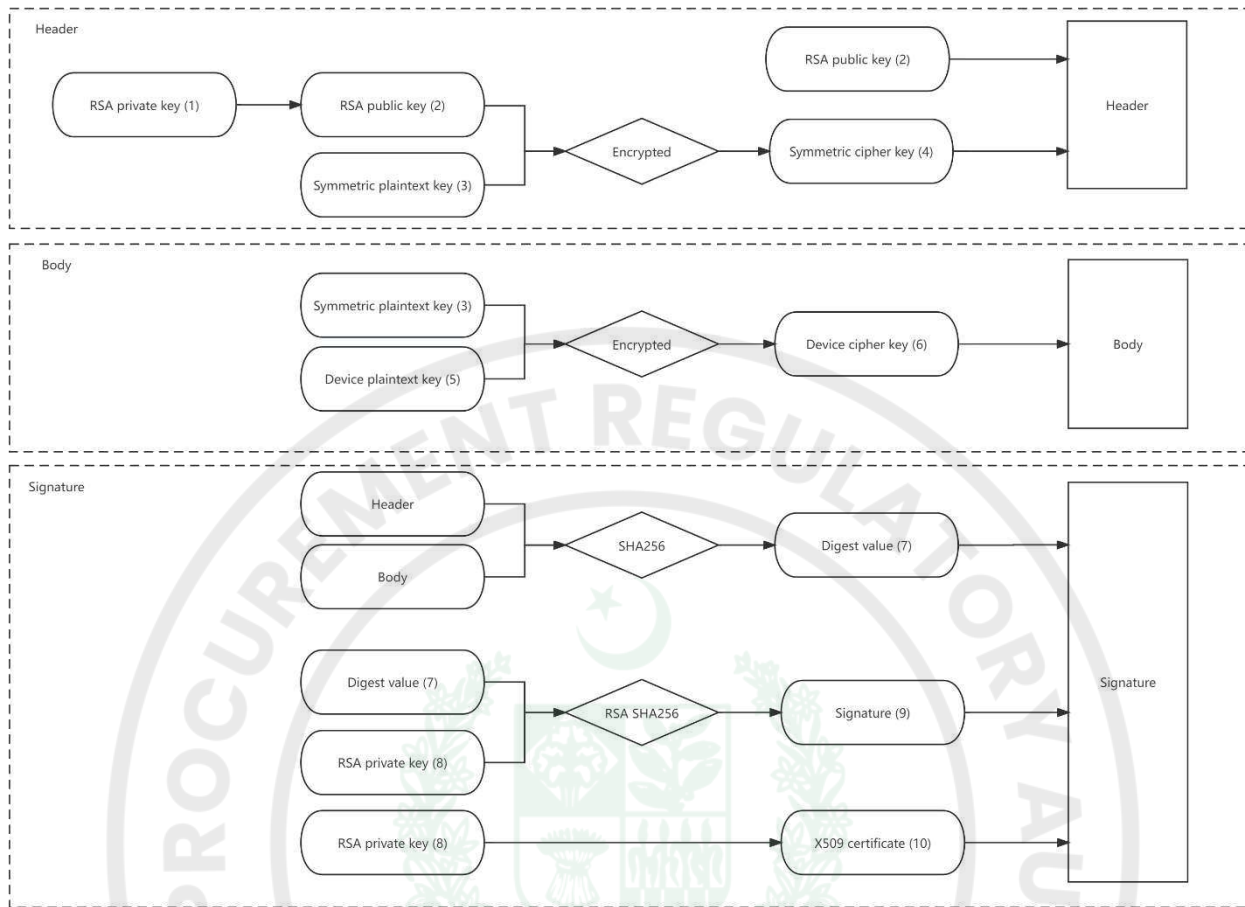

## 2.1 Shipment-file file generation process

### Step 1:

Export the basic information and key information of the device from the production system, Directly fill in the basic information of the device into the corresponding node of the XML file.

### Step 2:

Randomly generate Symmetric plaintext key(3), use the RSA public key(2) provided by the customer, perform asymmetric encryption, generate Symmetric cipher key(4), and put this information in the "/Envelope/Header/Security/Symmetric\_key/Cipher\_value" node. And put the RSA public Key (2) in the "/Envelope/Header/Security/Public\_key/Modulus" node.

### Step 3:

Use Symmetric plaintext key(3) to symmetrically encrypt Device plaintext key(5), generate Device cipher key(6), and place it in the node corresponding to Body.

### Step 4:

Using all the contents in the "<Header/>" and "<Body/>" nodes of the shipment-file file, use the SHA256 algorithm to derive the Digest value (7) and place it in "/Envelope/Signature/SignedInfo/Reference/DigestValue" node.

Use RSA private key(8) to encrypt Digest value(7) to generate Signature(9) and place it in the "/Envelope/Signature/SignatureValue" node.

Then generate X509 certificate (10) through RSA private key (8) and place it in the "/Envelope/Signature/KeyInfo/X509Data/X509Certificate" node.

**Step 5:**

After the generation of the XML file, the whole XML file will be encrypted again by certificate (10) through S/MIME using AES-256-CBC cipher, and the file will be converted to DER format.

## 2.2 Shipment-file file parsing process

**Step 1:**

Use the RSA private key (8) mentioned above to decrypt the whole XML file.

**Step 2:**

Use the certificate (10) generated by the RSA private key (8) mentioned above to perform signature verification on the Signature and verify the consistency of the file.

**Step 3:**

Obtain the Symmetric cipher key(4) in "/Envelope/Header/Security/Symmetric\_key/Cipher\_value", and use RSA private key(2) to perform RSA decryption to obtain the Symmetric plaintext key(3).

**Step 4:**

Use Symmetric plaintext key(3) to decrypt Device cipher key(6) and obtain Device plaintext key(5).

**Remark:**

RSA private key (1) and RSA public key (2) are in the device\_key folder.

RSA private key (8) and certificate (10) are in the signiture\_key folder.

## 3 XML Structure

### 3.1 Base Structure

```

1  <?xml version="1.0" encoding="utf-8"?>
2  <Envelope xmlns:tns="http://schemas.kaifa.cn/shipmentfile/2016-08">
3    <Header>
4      <Security>
5    </Security>
6  </Header>
7  <Body>
8    <Shipment>
9      <Main>
10     </Main>
11     <Header>
12     </Header>
13     <Device_attributes>
14     </Device_attributes>
15   </Shipment>
16 </Body>
17 <Signature>
18 </Signature>
19 </Envelope>

```

- Element description**

No.	Element	Parent Elements	Description	Required
2	Envelope		Root of the xml	Yes
3	Header	Envelope		Yes

4	Security	Envelope/Header	Secret key information	Yes
7	Body	Envelope		Yes
8	Shipment	Envelope /Body	Shipment Information The <Body> element contains only one < Shipment >	Yes
9	Main	Envelope/Body/ Shipment		No
11	Header	Envelope/Body/ Shipment		No
13	Device_attributes	Envelope/Body/ Shipment	Device attributes. If there are multiple devices, there will be multiple The <Shipment > element contains only one or more <Device_attributes>	Yes
17	Signature	Envelope	Signature Information	Yes

### 3.2 Security

```

1 <Security>
2   <Symmetric_key>
3     <Cipher_value></Cipher_value>
4   </Symmetric_Key>
5   <Public_key>
6     <Modulus></Modulus>
7     <Exponent></Exponent>
8   </Public_key>
9   <Certification_date></Certification_date>
10 </Security>

```

NO	XML line number	Attribute Name	Required
1	2	Symmetric_key	Yes
2	5	Public_key	Yes
3	9	Certification_date	Yes

- **Symmetric Key**

<pre> 1 &lt;Symmetric_key&gt; 2   &lt;Cipher_value&gt;&lt;/Cipher_value&gt; 3 &lt;/Symmetric_Key&gt; </pre>						
No.	Element	Parent Element	Description	Length	Type	Required
2	Cipher_value	Envelope/Header /Security/Symmetri c_key		Indefinite length	String	Yes

- **Public Key**

Title:	Shipment Specification	Ver.	1.3	Page:	143 of 154
--------	------------------------	------	-----	-------	------------

```

1 <Public_key>
2   <Modulus></Modulus>
3   <Exponent></Exponent>
4 </Public_key>

```

No.	Element	Parent Element	Description	Length	Type	Required
2	Modulus	Envelope/Header /Security/Public_key		Uncertain length	String	Yes
3	Exponent	Envelope/Header /Security/Public_key		Uncertain length	String	Yes

- **Certification Date**

```

1 <Certification_date></Certification_date>

```

No.	Element	Parent Element	Description	Length	Type	Required
1	Certification_date	Envelope/Header /Security/ Certification_date		19	String (yyyy/mm/dd hh:mi:ss)	Yes

### 3.3 Shipment

- **Main**

```

1 <Main>
2   <Company></Company>
3   <Supplier></Supplier>
4 </Main>

```

No.	Element	Parent Element	Description	Length	Type	Required
2	Company	Envelope/Body/ Shipment	For example: JSC Uzbekenergo	Indefinite length	String	Yes
3	Supplier	Envelope/Body/ Shipment	For example: KAIFA	Indefinite length	String	Yes

- **Header**

```

1 <Header>
2   <Configuration_version></Configuration_version>
3   <Delivery_date></Delivery_date>
4 </Header>

```

No.	Element	Parent Element	Description	Length	Type	Required
2	Configuration_version	Envelope/Body /Main		Indefinite length	String	No

3	Delivery_date	Envelope/Body /Main	Device delivery date	19	String YYYY/MM/D D HH24:MI:SS 2018/11/15 00:00:00	Yes
---	---------------	------------------------	----------------------------	----	--	-----

- **Device\_attributes**

Device attributes information. If there are multiple devices, there will be multiple <Device\_attributes> </Device\_attributes> elements under < Shipment >.

#### 4 Device Attributes

```

<Device_attributes>
  <General>
    <Serial_number>09122400021426</Serial_number>
    <Logic_device_name>KTML020100021426</Logic_device_name>
    <Device_type>01</Device_type>
    <Device_batch_number>2024-08-21</Device_batch_number>
    <Device_pallet_number>P11A0000000044</Device_pallet_number>
    <Device_box_number/>
    <Date_of_manufactory>20240706</Date_of_manufactory>
    <Hardware_version>V0.1</Hardware_version>
    <App_software_version>000004</App_software_version>
    <Legal_software_version>010003</Legal_software_version>
    <Model_code>KA100M</Model_code>
    <System_title>4046406610005302</System_title>
    <Product_code>KA100M</Product_code>
    <Communication_type>33</Communication_type>
    <Communication_attribute>09122400021426</Communication_attribute>
    <HES>NEW-HES<HES>
  </General>
  <Communication_attributes>
    <modem>
      <Module_model_code/>
      <Module_communication_type/>
      <Module_software_version/>
      <Module_hardware_version/>
    </modem>
  </Communication_attributes>
  <Dlms_attributes>
    <Master_key>
      <Cipher_data>
        <Cipher_value/>
      </Cipher_data>
    </Master_key>
    <Global_encryption_unicast_key>
      <Cipher_data>
        <Cipher_value/>
      </Cipher_data>
    </Global_encryption_unicast_key>
    <Authentication_key>
      <Cipher_data>
        <Cipher_value/>
      </Cipher_data>
    </Authentication_key>
    <Global_broadcast_key>
      <Cipher_data>
        <Cipher_value/>
      </Cipher_data>
    </Global_broadcast_key>
  </Dlms_attributes>
</Device_attributes>

```

NO	XML line number	Attribute Name	HES Required	
			Meter	DCU

1	3	Serial_number	Yes	Yes
2	4	Logic_device_name	Yes	Yes
3	5	Device_type	Yes	Yes
4	6	Device_batch_number	Yes	Yes
5	7	Device_pallet_number	Yes	Yes
6	8	Device_box_number	Yes	Yes
7	9	Date_of_manufactory	Yes	Yes
8	10	Hardware_version	Yes	Yes
9	11	App_software_version	Yes	Yes
10	12	Legal_software_Version	Yes	No
11	13	Model_code	Yes	Yes
12	14	System_title	Yes	Yes
13	15	Product_code	Yes	Yes
14	16	Communication_type	Yes	Yes
15	17	Communication_attribute	Yes	Yes
16	18	HES	No	No
17	22	Module_model_code	Yes	Yes
18	23	Module_communication_type	Yes	Yes
19	24	Module_software_version	Yes	Yes
20	25	Module_hardware_version	Yes	Yes
21	31	Master_key	Yes	Yes
22	36	Global_encryption_unicast_key	Yes	Yes
23	41	Authentication_key	Yes	Yes
24	46	Global_broadcast_key	Yes	Yes

## 4.1 Serial Number

Serial_number	
XML line number	3
Element Name	Serial_number
Parent Elements	Envelope/Body/Shipment/Device_attributes/General
Description	Device No.
Length	Uncertain length
Type	String
Required	Meter: Yes DCU:Yes
Example	011156431171

## 4.2 Logic Device Name

Logic_device_name	
XML line number	4
Element Name	Logic_device_name
Parent Elements	Envelope/Body/Shipment/Device_attributes/General
Description	Logic Device Name
Length	Uncertain length
Type	String
Required	Meter: Yes DCU:Yes
Example	KFM011156431171

## 4.3 Device Type

Device Type	
XML line number	5
Element Name	Device_type
Parent Elements	Envelope/Body/Shipment/Device_attributes/General
Description	01 Single Phase Meter 03 Three Phase Meter 04 CT Meter 05 CT/VT Meter 09 DCU
Length	2
Type	Numeric
Required	Meter: Yes DCU:Yes
Example	10

## 4.4 Device Batch Number

Device Batch Number	
XML line number	6
Element Name	Device_batch_number
Parent Elements	Envelope/Body/Shipment/Device_attributes/General
Description	Device Batch Number
Length	Uncertain length

Title:	Shipment Specification	Ver.	1.3	Page:	of 17
--------	------------------------	------	-----	-------	-------

Type	String
Required	Meter: Yes DCU: Yes
Example	Defined by process:S22A830R0001

#### 4.5 Device Pallet Number

Device Pallet Number	
XML line number	7
Element Name	Device_pallet_number
Parent Elements	Envelope/Body/Shipment/Device_attributes/General
Description	Device Pallet Number
Length	Uncertain length
Type	String
Required	Meter: Yes DCU: Yes
Example	Maintenance by production: P22A017000004

#### 4.6 Device Box Number

Device Box Number	
XML line number	8
Element Name	Device_box_number
Parent Elements	Envelope/Body/Shipment/Device_attributes/General
Description	Device Box Number
Length	Uncertain length
Type	String
Required	Meter: Yes DCU: Yes
Example	Maintenance by production: C22A017000054

#### 4.7 Date of Manufactory

Date of Manufactory	
XML line number	9
Element Name	Date_of_manufactory
Parent Elements	Envelope/Body/Shipment/Device_attributes/General
Description	Date of manufacture, format YYYYMMDD
Length	Uncertain length
Type	Numeric
Required	Meter: Yes DCU: Yes
Example	20160904

#### 4.8 Hardware Version

Hardware Version	
XML line number	10
Element Name	Hardware_version

Parent Elements	Envelope/Body/Shipment/Device_attributes/General
Description	Hardware Version
Length	Uncertain length
Type	String
Required	Meter: Yes DCU:Yes
Example	V11.2

#### 4.9 App Software Version

App Software Version	
XML line number	11
Attribute Name	App_software_version
Parent Elements	Envelope/Body/Shipment/Device_attributes/General
Description	App Software Version
Length	Uncertain length
Type	String
Required	Meter: Yes DCU:Yes
Example	KF11A017-K01-0000 MA110-B01-S01-02 V0118-00

System Title	
XML line number	14
Attribute Name	System_title

Parent Elements	Envelope/Body/Shipment/Device_attributes/General
-----------------	--

#### 4.10 Legal Software Version

Legal Software Version	
XML line number	12
Attribute Name	Legal_software_version
Parent Elements	Envelope/Body/Shipment/Device_attributes/General
Description	Legal Software Version
Length	Uncertain length
Type	String
Required	Meter: Yes DCU:No
Example	KF11A017-K01-0000 MA110-B01-S01-02 V0118-00

#### 4.11 Model Code

Model Code	
XML line number	13
Attribute Name	Model_code
Parent Elements	Envelope/Body/Shipment/Device_attributes/General
Description	Model Code
Length	Uncertain length
Type	String
Required	Meter: Yes DCU: Yes
Example	MA110U

#### 4.12 System Title

Description	Model_code
Length	Uncertain length
Type	String
Required	Meter: Yes DCU: Yes
Example	MA110U

#### 4.13 Product Code

Product Code	
XML line number	15
Attribute Name	Product_code
Parent Elements	Envelope/Body/Shipment/Device_attributes/General
Description	Product Code
Length	Uncertain length
Type	String
Required	Meter: Yes DCU: Yes
Example	MA110U

#### 4.14 Communication Type

Communication Type	
XML line number	16
Attribute Name	Communication_type
Parent Elements	Envelope/Body/Shipment/Device_attributes/General
Description	Communication Type
Length	Uncertain length
Type	06 PLC 33 GPRS
Required	Meter: Yes DCU:Yes
Example	6

#### 4.15 Communication Attribute

Communication Attribute	
XML line number	17
Attribute Name	Communication_attribute
Parent Elements	Envelope/Body/Shipment/Device_attributes/General
Description	Communication Attribute
Length	Uncertain length
Type	String
Required	Meter: Yes DCU:Yes
Example	MCA202102031001

#### 4.16 HES

HES	
XML line number	18

Elements Name	HES
Parent Elements	Envelope/Body/Shipment/Device_attributes/General
Description	The meter or DCU belongs to which HES. This attribute, which will be KAIFA by default, and it's not mandantory for the meters belongs to KAIFA HES, but mandantory for the new brand meters which belongs to the new HES in the future.
Length	Uncertain length
Type	String
Required	Meter: No DCU: No
Example	NEW-HES (The name will be specified in MDMS)

#### 4.17 Module Model Code

Module Model Code	
XML line number	22
Elements Name	Module_model_code
Parent Elements	Envelope/Body/Shipment/Device_attributes/Communication_attributes/Modem
Description	Module Model Code, (multiple are supported in DCU)
Length	Uncertain length
Type	String
Required	Meter: Yes DCU: Yes
Example	A30056431090

#### 4.18 Module Communication Type

Module Communication Type	
XML line number	23
Element Name	Module_communication_type
Parent Elements	Envelope/Body/Shipment/Device_attributes/Communication_attributes/Modem
Description	Communication mode (module type) 06 PLC 33 GPRS (multiple are supported in DCU)
Length	1
Type	Numeric
Required	Meter: Yes DCU: Yes
Example	6

#### 4.19 Module Hardware Version

Module Hardware Version	
XML line number	24
Element Name	Module_hardware_version
Parent Elements	Envelope/Body/Shipment/Device_attributes/Communication_attributes/Modem
Description	Module Hardware Version, (multiple are supported in DCU)
Length	Uncertain length
Type	String

Required	Meter: Yes DCU: Yes
Example	V5.0

#### 4.20 Module Software Version

Module Software Version	
XML line number	25
Element Name	Module_software_version
Parent Elements	Envelope/Body/Shipment/Device_attributes/Communication_attributes/Mo dem
Description	Module Software Version, (multiple are supported in DCU)
Length	Uncertain length
Type	String
Required	Meter: Yes DCU: Yes
Example	V0115

#### 4.21 Master Key

Master key	
XML line number	36
Element Name	Cipher_value
Parent Elements	Envelope/Body/Shipment/Device_attributes/Dlms_attributes/Master_key/Cipher_data
Description	Need to use supplier key for Grid operator encryption (KEK)
Length	Uncertain length
Type	Base64 encoding
Required	Meter: Yes DCU: Yes
Example	Rty3eHO3fW/rasfsVI/N3Ebct3hzt31v62rH7FSPzdxESXkPwZwicFrgFw3Oh8Vt

#### 4.22 Global Encryption Unicast Key

Global Encryption Unicast Key	
XML line number	41
Element Name	Cipher_value
Parent Elements	Envelope/Body/Shipment/Device_attributes/Dlms_attributes/Global_encryption_unicast_key/Cipher_data
Description	Need to use supplier key for Grid operator encryption (KEK)
Length	Uncertain length
Type	Base64 encoding
Required	Meter: Yes DCU: Yes
Example	3xIF8od204Je4/flymUSmd8SBfKHdtOCXuP35cplEplESXkPwZwicFrgFw3Oh8Vt

#### 4.23 Authentication Key

Authentication Key	
XML line number	46

Element Name	Cipher_value
Parent Elements	Envelope/Body/Shipment/Device_attributes/Dlms_attributes/Authentication_key/Cipher_data
Description	Need to use supplier key for Grid operator encryption (AKEY)
Length	Uncertain length
Type	Base64 encoding
Required	Meter: Yes DCU:Yes
Example	H+qnrZMcDUGiojYZ1Gymoh/qp62THA1BoqI2GdRspqJESXkPwZwicFrgFw30h8Vt

#### 4.24 Global Broadcast Key

Global Broadcast Key	
XML line number	51
Element Name	Cipher_value
Parent Elements	Envelope/Body/Shipment/Device_attributes/Dlms_attributes/Global_broadcast_key/Cipher_data
Description	Global Broadcast Encryption Key (BK)
Length	Uncertain length
Type	Base64 encoding
Required	Meter: Yes DCU:No
Example	H+qnrZMcDUGiojYZ1Gymoh/qp62THA1BoqI2GdRspqJESXkPwZwicFrgFw30h8Vt

### 5 Signature

```

1 <Signature>
2   <Signed_info>
3   </Signed_info>
4   <Signature_value>
5   </Signature_value>
6   <Key_info>
7   </Key_info>
8 </Signature>

```

NO	XML line number	Attribute Name	Required	
			Meter	DCU
1	2	Signed_info	Yes	Yes
2	4	Signature_value	Yes	Yes
3	6	Key_info	Yes	Yes

- Signed Info**

```

1 <Signed_info>
2   <Canonicalization_method Algorithm="http://www.w3.org/TR/2001/REC-xml-c14n-20010315"/>
3   <Signature_method Algorithm="http://www.w3.org/2001/04/xmldsig-more#rsa-sha256"/>
4   <Reference URI="">
5     <Transforms>
6       <Transform Algorithm="http://www.w3.org/2002/06/xmldsig-filter#2">
7         <XPath xmlns:ns3="http://www.w3.org/2002/06/xmldsig-filter#2" Filter="intersect"/*[local-name()='Header' or local-name()='Body']</XPath>
8       </Transform>
9     </Transforms>
10    <Digest_method Algorithm="http://www.w3.org/2001/04/xmldsig#sha256"/>
11    <Digest_value/></Digest_value>
12  </Reference>
13 </Signed_info>

```

No.	Element	Parent Element	Description	Length	Type	Required
2	Canonicalization_method	Envelope/Signature/Signed_info				Yes
3	Signature_method	Envelope/Signature/Signed_info				Yes
4	Reference	Envelope/Signature/Signed_info				Yes
5	Transforms	Envelope/Signature/Signed_info/ Reference				Yes
6	Transform	Envelope/Signature/Signed_info/Reference/Transforms				Yes
7	XPath	Envelope/Signature/Signed_info/Reference/Transforms/ Transform				Yes
10	Digest_method	Envelope/Signature/Signed_info/ Reference				Yes
11	Digest_value	Envelope/Signature/Signed_info		Uncertain length	String	Yes

• **Signature Value**

<pre> 1 &lt;Signature_value&gt; 2 &lt;/Signature_value&gt; </pre>						
No.	Element	Parent Element	Description	Length	Type	Required
1	Signature_value	Envelope/Signature/Signed_info		Uncertain length	String	Yes

• **Key Info**

<pre> 1 &lt;Key_info&gt; 2   &lt;X509_data&gt; 3     &lt;X509_certificate&gt; 4     &lt;/X509_certificate&gt; 5   &lt;/X509_data&gt; 6 &lt;/Key_info&gt; </pre>						
No.	Element	Parent Element	Description	Length	Type	Required
3	X509_certificate	Envelope/Signature/Key_info/X509_data/		Uncertain length	String	Yes

## 6 XML Example

Refer to “Shipment File\_Meter.xml” and “Shipment File\_DCU.xml”.

\*\*\*\*\*The End \*\*\*\*\*

# Type Test List for Single Phase Meter

- **Tests related to safety**
  1. Impulse voltage test
  2. AC power-frequency voltage test.
  3. Spring hammer test
  4. Protection against spread of fire
  5. Temperature test.
  6. Protection against penetration of dust
  7. Protection against penetration of water
- **Tests of mechanical requirements**
  8. Shock test
  9. Vibration test.
- **Accuracy requirements**
  10. Meter constant
  11. Initial start-up of the meter
  12. Test of no-load condition.
  13. Starting current test
  14. Repeatability test
  15. Limit of error due to variation of the current
  16. Time-keeping accuracy
  17. Test of time-keeping accuracy on operation reserve
  18. Test of time-keeping accuracy with temperature
- **Tests for electromagnetic compatibility (EMC) and limits of error due to Electromagnetic influence quantities**
  19. Voltage dips and short interruptions
  20. Electrostatic discharges.
  21. Radiated, radio-frequency, electromagnetic field immunity test - test without current
  22. Radiated, radio-frequency, electromagnetic field immunity test - test with current
  23. Electrical fast transient/burst immunity test
  24. Conducted disturbances induced by radio-frequency fields
  25. Test for immunity to conducted, differential mode disturbances and signalling in the frequency range 2 kHz to 150 kHz at AC power ports
  26. Surge immunity test
  27. Ring wave immunity test.
  28. External static magnetic fields
  29. Power frequency magnetic fields of external origin
  30. Conducted emission
  31. Radiated emission
- **Tests of immunity to other influence quantities**
  32. Harmonics in the current and voltage circuits - 5th harmonic test.
  33. Interharmonics in the current circuit - burst fired waveform test.
  34. Odd harmonic in the current circuit

35. DC and even harmonic - half-wave rectified waveform test.
36. Voltage variation
37. Ambient temperature variation
38. Frequency variation.
39. Operation of auxiliary devices.
40. Short-time over currents
41. Self-heating
42. Fast load current variations.
- Climatic condition
  43. Dry heat test
  44. Cold test
  45. Damp heat cyclic test
  46. Protection against solar radiation



# Interoperability Test Specification

IESCO AMI LAB CONSTRUCTION PROJECT



### Revision History

Version	Date	Changes	Checked	Approved by

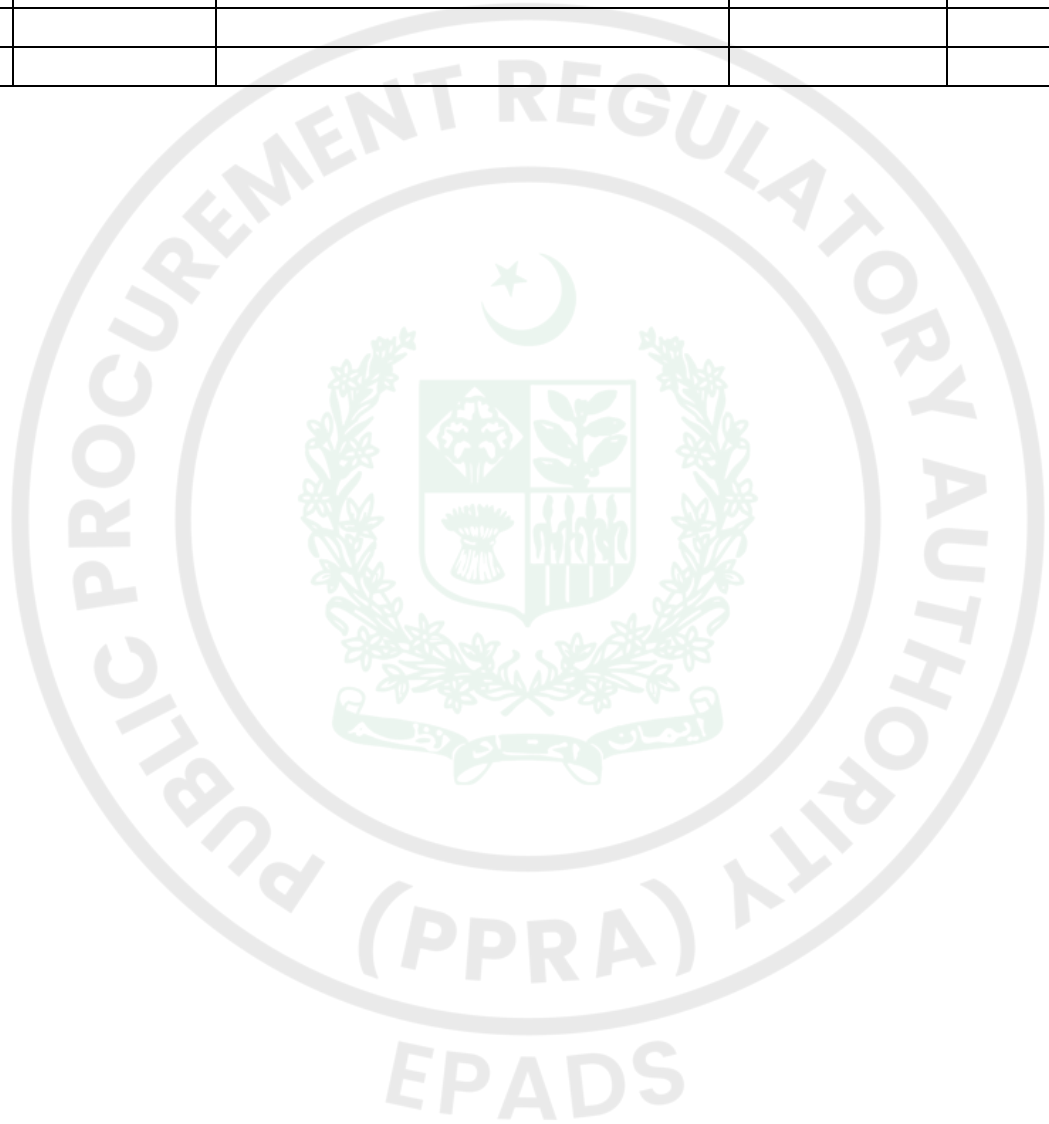

## Content

1	Overview .....	4
2	Abbreviations.....	5
3	Test Scope and Method.....	6
3.1	E-Meter with Cellular Communication.....	6
3.1.1	E-Meter Functional Test.....	6
3.1.2	Cellular Performance Test.....	22
3.1.3	Integration Test- Cellular Meter to HES(MI2).....	24
3.2	E-Meter with PLC Communication .....	35
3.2.1	E-Meter Functional Test.....	35
3.2.2	PLC Performance Test .....	36
3.2.3	Integration Test-G3 PLC Meter to DCU/HES (MI1).....	50
3.3	DCU with G3 PLC/Cellular Communication .....	58
3.3.1	DCU Functional Test .....	59
3.3.2	Cellular Performance Test.....	76
3.3.3	G3 PLC Performance Test .....	76
3.3.4	Integration Test-DCU (CI1,CI2) .....	76
3.4	HES.....	88
3.4.1	Integration Test-MDMS to HES (CIM) .....	88
3.5	PLC filter function test.....	93
3.5.1	Noise attenuation test.....	93
3.5.2	Power consumption test .....	94
3.6	Real Environment Simulation Test .....	96
3.6.1	PLC network performance test .....	96
3.6.2	Cellular network performance test.....	99
4	References .....	103

Title:	Interoperability Test Specification	Ver.	2.0	Page:	4 of 103
--------	-------------------------------------	------	-----	-------	----------

# 1 Overview

IESCO AMI project in Islamabad is a state-of-the-art project in Pakistan. The state-of-the-art Laboratory Facility Construction is a critical investment in this project. Through meticulous planning, effective risk management, and active stakeholder engagement, we are committed to delivering a facility that meets the highest standards of quality and functionality.

The construction of a new AMI laboratory facility is a strategic initiative aimed at enhancing IESCO capabilities and supporting the growing needs of AMI interoperability. This project will provide a modern, fully-equipped environment to support the completion of AMI meter test, which include Routine Tests, Interoperability Tests, and Data Retrieve Tests.

This document aims to define the scope, test methods, instruments and implementation details for the Interoperability Test, covering the test design for the following products belongs to the IESCO AMI Project.

- E-Meter with Cellular/G3 PLC communication: Evaluate the meter functionality against requirements, assess module hardware performance, system integration (MI2, MI1 Interface), and performance in real environment simulation.
- DCU with Cellular/G3 PLC communication: Evaluate the DCU functionality against requirements, assess module hardware performance, system integration (CI1, CI2 Interface), and performance in real environment simulation.
- HES CIM Interface: Evaluate the HES CIM interface (SI2) implementation against CIM requirements.
- Filter: Evaluate the function of the filter.

## 2 Abbreviations

Abbreviation	Description
DUT	Device Under Test
AMI	Advanced Metering Infrastructure
SM	Smart Meter
DLMS	Device Language Message Specification
TCP	Transport Control Protocol
PLC	Power Line Communications
DCU	Data Concentrator Unit
HES	Head End System
MDMS	Meter Data Management System
CIM	Common Information Model
IPS	Isolated Power Supply
BOM	Bill of Materials

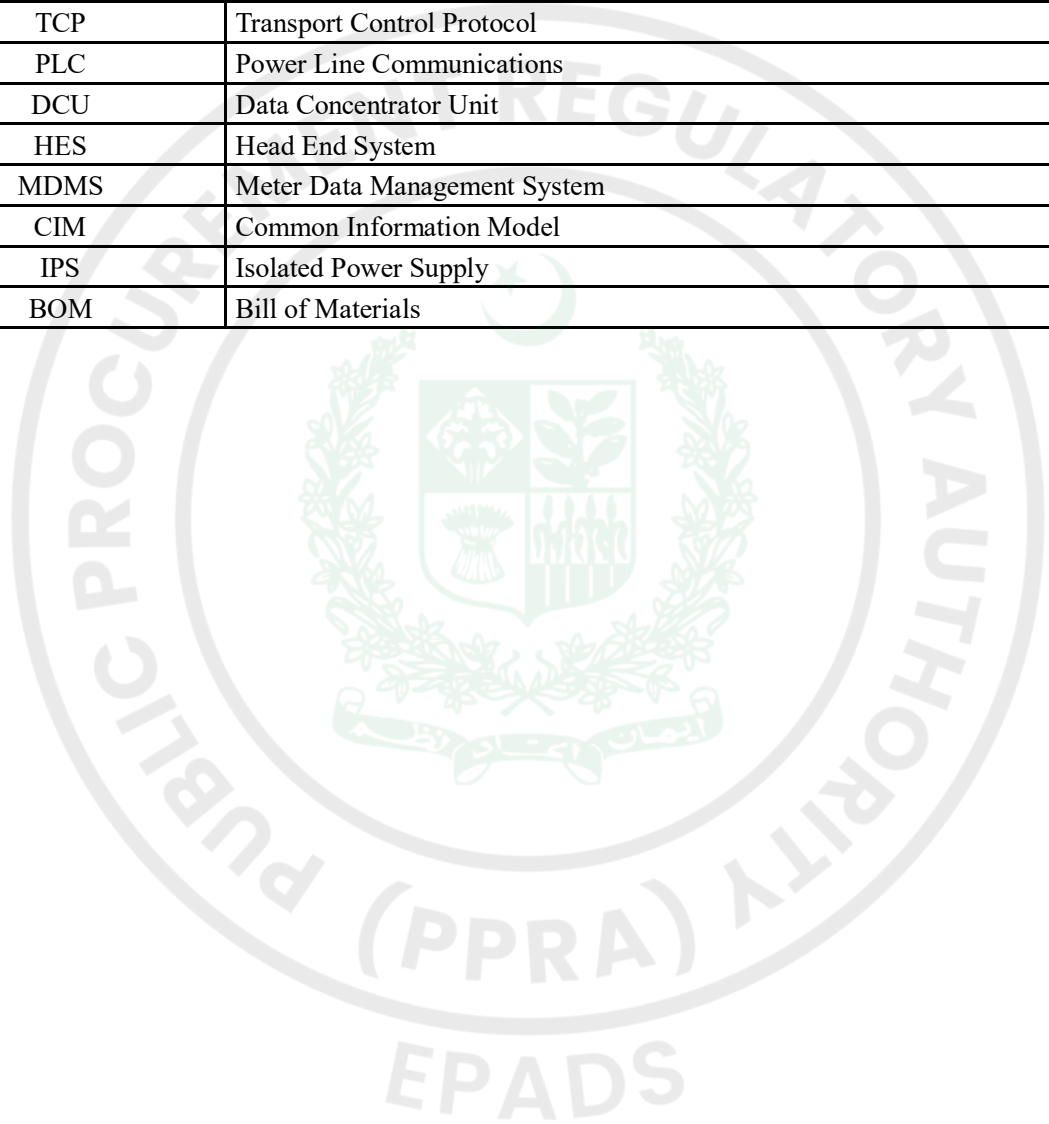

### 3 Test Scope and Method

This chapter will centre on the product, providing a comprehensive overview of the essential tests required when new supplier products are integrated into the IESCO AMI system. It will encompass a detailed description of the testing environment, the equipment utilized, and the specific methodologies employed.

#### 3.1 E-Meter with Cellular Communication

For E-Meter (SP/PP/CT/CTPT) with Cellular Communication, the following tests must be conducted to ensure compatibility and seamless integration with other devices specified in the IESCO AMI Project.

- STEP1 Basic Function Compliance Test
  - E-Meter Functional Test
  - Cellular Communication Performance Test
- STEP2 Integration Test-Cellular Meter to HES(MI2)
- STEP3 Real Environment Simulation Test

The DUT samples and reports/certificate should be provided by meter supplier

No.	Device	Qty.	Provider	Description
1	DUT Sample	30	Meter Supplier	<ul style="list-style-type: none"> <li>• 1pcs for Function Test</li> <li>• 1pcs for Cellular Test</li> <li>• 1pcs for Integration Test</li> <li>• 20pcs for Real Enviroment SimulationTest</li> <li>• 7pcs backup</li> </ul>
2	DLMS Certification	1	Meter Supplier	<ul style="list-style-type: none"> <li>• DLMS Protocol certificate (CTT4.3)</li> </ul>
3	Firmware update file	1	Meter Supplier	<ul style="list-style-type: none"> <li>• DUT firmware File for upgrade testing</li> </ul>
4	DUT Test Report	1	Meter Supplier	<ul style="list-style-type: none"> <li>• Type test report</li> <li>• Software test report</li> </ul>
5	Shipment file	1	Meter Supplier	<ul style="list-style-type: none"> <li>• Include secret keys of different clients</li> </ul>
6	Software Tool	1	Meter Supplier	<ul style="list-style-type: none"> <li>• Software testing tool offered by different manufacturers to support local/remote connection and operation with Meter</li> </ul>
7	Cellular Network	-	IESCO	<ul style="list-style-type: none"> <li>• Support 2G and LTE</li> <li>• Support verify the APN (Access Point Name)</li> <li>• Support verify the PPP information</li> <li>• Support IPv4/v6</li> <li>• LTE Support Band1/Band3/Band5/Band8</li> <li>• 2G</li> </ul>

Table 3-1 DUT Requirements for E-Meter with Cellular Communication

##### 3.1.1 E-Meter Functional Test

This test aims to detect if there is any failures or errors of E-meter with Cellular Communication Solution. Testing content mainly includes DLMS protocol conformance, clock, display, measurement, demand, billing, firmware upgrade, tariff, profile, power quality, prepayment, load control, security and communication.

### 3.1.1.1 Smart Meter Function

#### 3.1.1.1.1 Test Suite

The test suite consists of 17 test groups, which are DLMS protocol conformance, meter basic information, real time clock, LCD display, measurement, demand, load profile, billing profile, calendar and tariff management, power quality, load control, firmware upgrade, event and status word, security, prepayment and optical and RS485 communication.

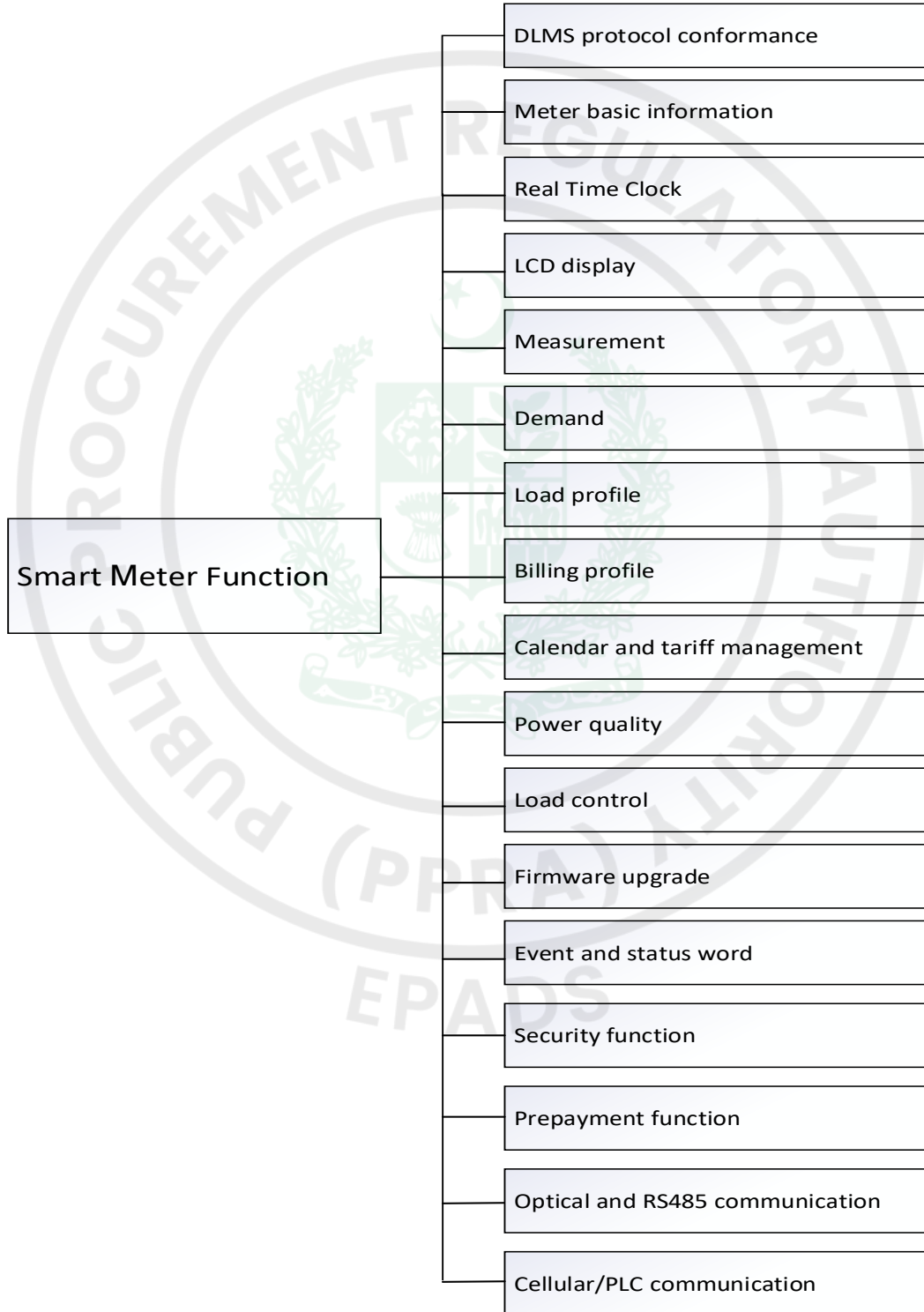

**Figure 3-1 Test Groups of Cellular Meter**

No.	Test Group ID	Test Group Name
1	SM-FUNC-DLMS	DLMS protocol conformance
2	SM-FUNC-MBI	Meter basic information
3	SM-FUNC-RTC	Real Time Clock
4	SM-FUNC-LCD	LCD display
5	SM-FUNC-ME	Measurement
6	SM-FUNC-DE	Demand
7	SM-FUNC-LP	Load profile
8	SM-FUNC-BP	Billing profile
9	SM-FUNC-TOU	Calendar and tariff management
10	SM-FUNC-PQ	Power quality
11	SM-FUNC-RC	Load control
12	SM-FUNC-FW	Firmware upgrade
13	SM-FUNC-EVE	Event and status word
14	SM-FUNC-SE	Security function
15	SM-FUNC-PM	Prepayment function
16	SM-FUNC-COM	Optical and RS485 communication
17	SM-FUNC-CELL	Cellular communication

Table 3-2 Test Group List of Cellular Meter

3.1.1.1.2 Test Setup

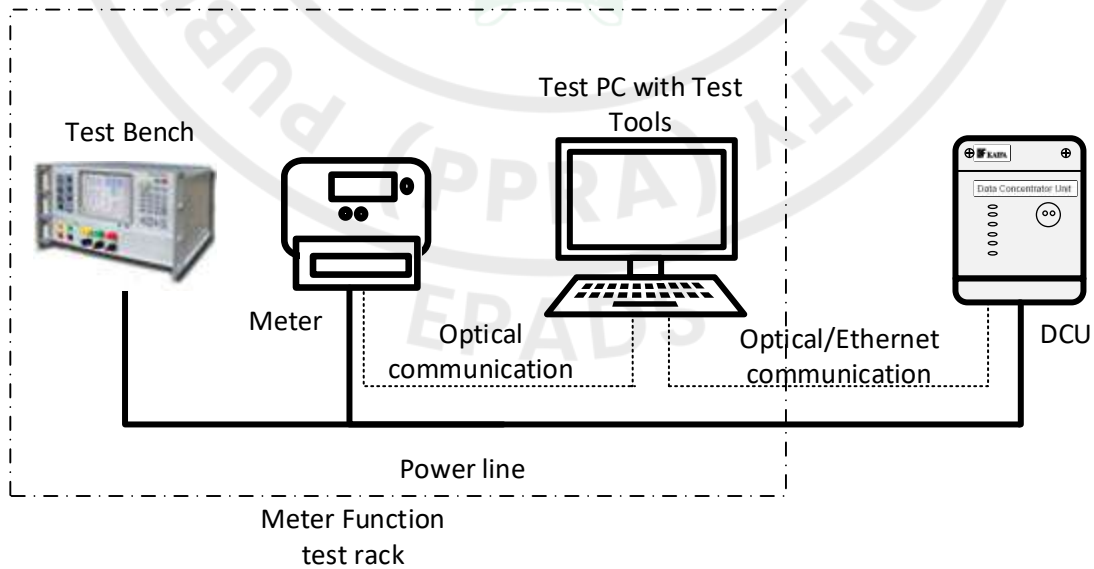

Figure 3-2 Meter Function Auto Test Setup

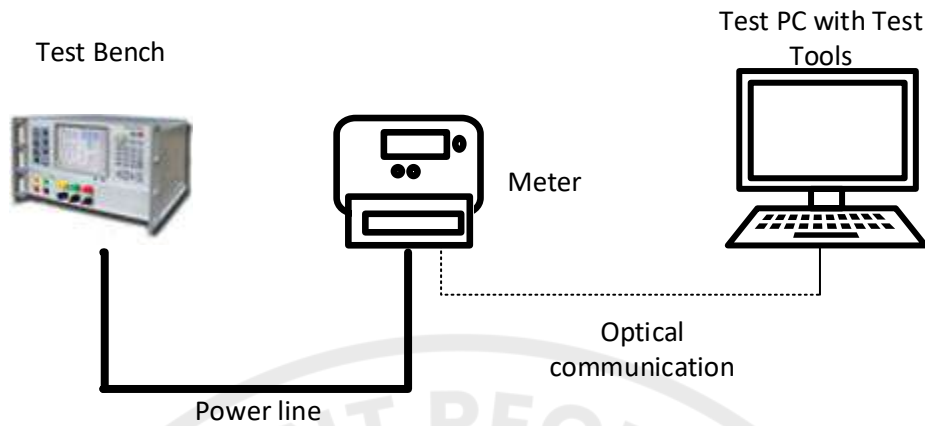

Figure 3-3 Meter Function Manual Test Setup

No.	Device	Qty.	Description
1	Meter Function Test Rack	1	• Meter calibration device, power supply to the DUT(for auto test setup)
2		1	• Rack(for auto test setup)
3		1	• Computer • PC connect DUT meter via Optical port
4		1	• Auto test software, used to schedule automated test execution
5		1	• Auxiliary test equipment, only used when testing G3 PLC meters.
6	Test Bench	1	• Meter calibration device, power supply to the DUTs
7	Cellular Network	-	<ul style="list-style-type: none"> <li>• IESCO provided</li> <li>• Support GPRS and LTE</li> <li>• Support verify the APN (Access Point Name)</li> <li>• Support verify the PPP information</li> <li>• Support IPv4/v6</li> </ul>

Table 3-3 Device List for Function Test Setup

### 3.1.1.1.3 Test Group DLMS protocol conformance

Test Group Information			
Test Group ID	SM-FUNC-DLMS	Test Group Name	DLMS protocol conformance
References	<ul style="list-style-type: none"> <li>• [1] IESCO_AMI_Project, Technical Specification Smart Meter Companion Specification,</li> <li>• [2] DLMS User Association, DLMS UA 1000-1 Ed.14, 2020.</li> <li>• [3] DLMS User Association, DLMS UA 1000-2 Ed.10, 2020.</li> <li>• [4] IESCO_AMI_Project, dlms_obis_list</li> </ul>		
Test Purpose	<ul style="list-style-type: none"> <li>• Check class ID and access rights according to Association LN object, including get, set, action.</li> </ul>		

	<ul style="list-style-type: none"> <li>The data format in the response from E-meter and communication process must confirm with [2] [3]</li> </ul>	
Test Setup and Condition	<ul style="list-style-type: none"> <li>Figure 3-2 Meter Function Auto Test Setup</li> </ul>	
Test Method	<ul style="list-style-type: none"> <li>Automated test platform, using the Auto test Tool to check the class ID and access rights and client application association</li> </ul>	
Acceptance Criteria	<ul style="list-style-type: none"> <li>The data format in the response from E-meter must confirm with [1] [2] [3] [4]</li> <li>All test cases in following list are executed and passed.</li> </ul>	
Test Case Lists		
ID	Case Title	Test Type
SM-FUNC-DLMS-001	Check the access rights of all clients in SM	Auto
SM-FUNC-DLMS-002	Check communication process complying DLMS protocol	Auto
SM-FUNC-DLMS-003	Check data transfer service of SM	Auto
SM-FUNC-DLMS-004	Check data framed complying corresponding communication profiles	Auto
SM-FUNC-DLMS-005	Invalid value of each data frame field test	Auto

#### 3.1.1.1.4 Test Group Meter basic information

Test Group Information			
Test Group ID	SM-FUNC-MBI	Test Group Name	Meter basic information
References	<ul style="list-style-type: none"> <li>[1] IESCO_AMI_Project, Technical Specification Smart Meter Companion Specification,</li> <li>[2] DLMS User Association, DLMS UA 1000-1 Ed.14, 2020.</li> </ul>		
Test Purpose	<ul style="list-style-type: none"> <li>Checking the System Title and logical device name</li> </ul>		
Test Setup and Condition	<ul style="list-style-type: none"> <li>Figure 3-2 Meter Function Auto Test Setup</li> </ul>		
Test Method	<ul style="list-style-type: none"> <li>Automated test platform, using the Auto test Tool to check the System Title and logical device name and Device ID</li> </ul>		
Acceptance Criteria	<ul style="list-style-type: none"> <li>The meter basic information must confirm with [1] [2]</li> <li>All test cases in following list are executed and passed</li> </ul>		
Test Case Lists			
ID	Case Title		Test Type
SM-FUNC-MBI-001	Check the System Title		Auto
SM-FUNC-MBI-002	Check the logical device name and Device ID		Auto
SM-FUNC-MBI-003	Check the firmware version number		Auto

#### 3.1.1.1.5 Test Group Real Time Clock

Test Group Information			
Test Group ID	SM-FUNC-RTC	Test Group Name	Real Time Clock
References	<ul style="list-style-type: none"> <li>[1] IESCO_AMI_Project, Technical Specification Smart Meter Companion Specification</li> <li>[2] DLMS User Association, DLMS UA 1000-1 Ed.14, 2020.</li> </ul>		
Test Purpose	<ul style="list-style-type: none"> <li>Checking default value, data type, right of the corresponding obis</li> <li>Using equivalent class method to design data for testing clock-related parameters such as time, zone, deviation, status</li> </ul>		

	<ul style="list-style-type: none"> <li>Power on meter for a long time and observe the error of clock accuracy</li> </ul>	
Test Setup and Condition	<ul style="list-style-type: none"> <li>Figure 3-2 Meter Function Auto Test Setup</li> </ul>	
Test Method	<ul style="list-style-type: none"> <li>Automated test platform, using the Auto test Tool to set and read clock</li> </ul>	
Acceptance Criteria	<ul style="list-style-type: none"> <li>The data format in the response from E-meter must confirm with [1] [2]</li> <li>All test cases in following list are executed and passed</li> </ul>	
Test Case Lists		
ID	Case Title	Test Type
SM-FUNC-RTC-001	Check clock runs properly	Auto
SM-FUNC-RTC-002	Check default value	Auto
SM-FUNC-RTC-003	Check the adjust time function	Auto

### 3.1.1.1.6 Test Group LCD Display

Test Group Information			
Test Group ID	SM-FUNC-LCD	Test Group Name	LCD Display
References	<ul style="list-style-type: none"> <li>[1] IESCO_AMI_Project, Technical Specification Smart Meter Companion Specification</li> </ul>		
Test Purpose	<ul style="list-style-type: none"> <li>Check the default value and capture object data</li> <li>Confirming the Auto scroll mode, Manual scroll mode and Supply disconnection display mode are implemented correctly</li> <li>Confirming the timely display of data updates</li> </ul>		
Test Setup and Condition	<ul style="list-style-type: none"> <li>Figure 3-3 Meter Function Manual Test Setup</li> </ul>		
Test Method	<ul style="list-style-type: none"> <li>Manually test, for the test case which cannot be tested automatically, like LCD display test</li> </ul>		
Acceptance Criteria	<ul style="list-style-type: none"> <li>Meter can display data correctly</li> <li>No missing pen, no garbled</li> <li>The result must confirm with [1]</li> <li>All test cases in following list are executed and passed</li> </ul>		
Test Case Lists			
ID	Case Title		Test Type
SM-FUNC-LCD-001	Auto scroll mode test with default condition and data correction		Manual
SM-FUNC-LCD-002	Auto scroll mode test in prepayment (SP, PPDC).		Manual
SM-FUNC-LCD-003	Auto scroll mode test in export function mode		Manual
SM-FUNC-LCD-004	Auto scroll mode test in prepayment and export function mode (SP, PPDC).		Manual
SM-FUNC-LCD-005	Manual scroll mode test with default condition		Manual
SM-FUNC-LCD-006	Manual scroll mode test in prepayment (SP, PPDC).		Manual
SM-FUNC-LCD-007	Manual scroll mode test in export function mode		Manual
SM-FUNC-LCD-008	Manual scroll mode test in prepayment and export function mode (SP, PPDC).		Manual
SM-FUNC-LCD-009	Supply disconnection display mode test with default condition		Manual
SM-FUNC-LCD-010	Supply disconnection display mode test in prepayment (SP, PPDC).		Manual
SM-FUNC-LCD-011	Supply disconnection display mode test in export function mode		Manual
SM-FUNC-LCD-012	Supply disconnection display mode test in prepayment and export function mode (SP, PPDC).		Manual

### 3.1.1.1.7 Test Group Measurement

Test Group Information			
Test Group ID	SM-FUNC-ME	Test Group Name	Measurement
References	<ul style="list-style-type: none"> <li>[1] IESCO_AMI_Project, Technical Specification Smart Meter Companion Specification</li> <li>[2] DLMS User Association, DLMS UA 1000-1 Ed.14, 2020.</li> </ul>		
Test Purpose	<ul style="list-style-type: none"> <li>Confirming the correctness of the measurement</li> </ul>		
Test Setup and Condition	<ul style="list-style-type: none"> <li>Figure 3-2 Meter Function Auto Test Setup</li> </ul>		
Test Method	<ul style="list-style-type: none"> <li>Automated test platform, using the TEST BENCH to add the corresponding load condition and using the Auto test Tool to read the data related to measurement</li> </ul>		
Acceptance Criteria	<ul style="list-style-type: none"> <li>The measurement algorithm and accuracy must confirm with [1] [2]</li> <li>All test cases in following list are executed and passed</li> </ul>		
Test Case Lists			
ID	Case Title		Test Type
SM-FUNC-ME-001	Measurement test		Auto

### 3.1.1.1.8 Test Group Demand

Test Group Information			
Test Group ID	SM-MD	Test Group Name	Demand
References	<ul style="list-style-type: none"> <li>[1] IESCO_AMI_Project, Technical Specification Smart Meter Companion Specification</li> </ul>		
Test Purpose	<ul style="list-style-type: none"> <li>Confirming the correctness of the demand measurement</li> </ul>		
Test Setup and Condition	<ul style="list-style-type: none"> <li>Figure 3-2 Meter Function Auto Test Setup</li> </ul>		
Test Method	<ul style="list-style-type: none"> <li>Automated test platform, using the TEST BENCH to add the corresponding load condition and using the Auto test Tool to read the data related to Demand</li> </ul>		
Acceptance Criteria	<ul style="list-style-type: none"> <li>The demand algorithm and accuracy must confirm with [1]</li> <li>All test cases in following list are executed and passed</li> </ul>		
Test Case Lists			
ID	Case Title		Test Type
SM-FUNC-MD-001	Demand default value test.		Auto
SM-FUNC-MD-002	Demand measurement test		Auto

### 3.1.1.1.9 Test Group Load profile

Test Group Information			
Test Group ID	SM-FUNC-LP	Test Group Name	Load profile
References	<ul style="list-style-type: none"> <li>[1] IESCO_AMI_Project, Technical Specification Smart Meter Companion Specification</li> <li>[2] DLMS User Association, DLMS UA 1000-1 Ed.14, 2020.</li> </ul>		
Test Purpose	<ul style="list-style-type: none"> <li>Confirming the correctness of the status word detection logic</li> <li>Confirming the correctness of the data update of the capture object</li> <li>Registering and updating rules</li> <li>Confirming the correctness of data records under normal circumstances</li> </ul>		

	<ul style="list-style-type: none"> <li>Confirming that the data update rules satisfy FIFO</li> </ul>
Test Setup and Condition	<ul style="list-style-type: none"> <li>Figure 3-2 Meter Function Auto Test Setup</li> </ul>
Test Method	<ul style="list-style-type: none"> <li>Automated test platform, using the Auto test Tool to check the load profile</li> </ul>
Acceptance Criteria	<ul style="list-style-type: none"> <li>The result must confirm with [1] [2]</li> <li>All test cases in following list are executed and passed</li> </ul>

#### Test Case Lists

ID	Case Title	Test Type
SM-FUNC-LP-001	Check the default value and configuration range of three load profiles	Auto
SM-FUNC-LP-002	Check Energy load profile with normal condition	Auto
SM-FUNC-LP-003	Check Daily load profile with normal condition	Auto
SM-FUNC-LP-004	Check Power quality load profile with normal condition	Auto
SM-FUNC-LP-005	Check the three load profiles with clock adjust	Auto
SM-FUNC-LP-006	Check the three load profiles with clock invalid	Manual
SM-FUNC-LP-007	Check the three load profiles with power failure	Auto
SM-FUNC-LP-008	Check the data update rules of three load profiles	Auto

#### 3.1.1.1.10 Test Group Billing profile

Test Group Information			
Test Group ID	SM-FUNC-BI	Test Group Name	Billing profile
References	<ul style="list-style-type: none"> <li>[1] IESCO_AMI_Project, Technical Specification Smart Meter Companion Specification</li> <li>[2] DLMS User Association, DLMS UA 1000-1 Ed.14, 2020.</li> </ul>		
Test Purpose	<ul style="list-style-type: none"> <li>Check the default value and capture object data</li> <li>Confirming the correctness of the data update of the capture object</li> <li>Registering and updating rules</li> <li>Confirming the correctness of data records under normal circumstances</li> <li>Confirming that the data update rules satisfy FIFO</li> </ul>		
Test Setup and Condition	<ul style="list-style-type: none"> <li>Figure 3-2 Meter Function Auto Test Setup</li> </ul>		
Test Method	<ul style="list-style-type: none"> <li>Automated test platform, using the Auto test Tool to check the billing profile</li> </ul>		
Acceptance Criteria	<ul style="list-style-type: none"> <li>The result must confirm with [1] [2]</li> <li>All test cases in following list are executed and passed</li> </ul>		
Test Case Lists			
ID	Case Title	Test Type	
SM-FUNC-BI-001	Check the default value and configuration range of billing profile	Auto	
SM-FUNC-BI-002	Check billing profile triggered with normal condition	Auto	
SM-FUNC-BI-003	Check the billing profile triggered with clock adjust	Auto	
SM-FUNC-BI-004	Check the billing profile triggered with power failure	Auto	
SM-FUNC-BI-005	Check remote command billing	Auto	
SM-FUNC-BI-006	Check the billing profile triggered with passive tariff activated	Auto	
SM-FUNC-BI-007	Check the billing profile triggered with payment mode switch (SP, PPDC)	Auto	
SM-FUNC-BI-008	Check the data update rules of billing profile	Auto	

### 3.1.1.1.11 Test Group Calendar and tariff management

Test Group Information		
Test Group ID	SM-FUNC-TOU	Test Group Name Calendar and tariff management
References	<ul style="list-style-type: none"> <li>[1] IESCO_AMI_Project, Technical Specification Smart Meter Companion Specification</li> <li>[2] DLMS User Association, DLMS UA 1000-1 Ed.14, 2020.</li> </ul>	
Test Purpose	<ul style="list-style-type: none"> <li>Check the default value and capture object data</li> <li>Checking default value, data type, right of the corresponding obis</li> <li>Tariff configuration</li> <li>Tariff activated</li> </ul>	
Test Setup and Condition	<ul style="list-style-type: none"> <li>Figure 3-2 Meter Function Auto Test Setup</li> </ul>	
Test Method	<ul style="list-style-type: none"> <li>Automated test platform, using the Auto test Tool to check the TOU function</li> </ul>	
Acceptance Criteria	<ul style="list-style-type: none"> <li>DUT can record the energy correctly according to the tariff</li> <li>DUT can record the event correctly related to tariff correctly</li> <li>Passive tariff can be activated correctly</li> <li>The result must confirm with [1] [2]</li> <li>All test cases in following list are executed and passed</li> </ul>	
Test Case Lists		
ID	Case Title	Test Type
SM-FUNC-TOU-001	Check default tariff table runs properly	Auto
SM-FUNC-TOU-002	Check the configure tariff table runs properly	Auto
SM-FUNC-TOU-003	Check the Configuring of the max TOU.	Auto
SM-FUNC-TOU-004	Check the tariff switch with clock adjust	Auto
SM-FUNC-TOU-005	Check the tariff switch with power failure	Auto

### 3.1.1.1.12 Test Group Power quality

Test Group Information		
Test Group ID	SM-FUNC-PQ	Test Group Name Power quality
References	<ul style="list-style-type: none"> <li>[1] IESCO_AMI_Project, Technical Specification Smart Meter Companion Specification</li> <li>[2] DLMS User Association, DLMS UA 1000-1 Ed.14, 2020.</li> </ul>	
Test Purpose	<ul style="list-style-type: none"> <li>Confirming the correctness of voltage sag/swell/cut Event under different conditions</li> <li>Confirming the correctness of load unbalance monitoring (only in PPDC, CT, CTPT meter).</li> <li>Confirming the correctness of THD (Total Harmonic Distortion) exceed limit monitoring (only in CT, CTPT meter).</li> <li>Confirming the correctness of “Export Energy” measurement function</li> </ul>	
Test Setup and Condition	<ul style="list-style-type: none"> <li>Figure 3-2 Meter Function Auto Test Setup</li> </ul>	
Test Method	<ul style="list-style-type: none"> <li>Automated test platform, using the TEST BENCH to add the corresponding voltage to generate the sag/swell/cut / load unbalance/ THD/ Export Energy condition and using Auto test Tool to check data</li> </ul>	
Acceptance Criteria	<ul style="list-style-type: none"> <li>The result must confirm with [1] [2]</li> <li>All test cases in following list are executed and passed</li> </ul>	

Test Case Lists		
ID	Case Title	Test Type
SM-FUNC-PQ-001	Check voltage sag L1 start and restore. (SP)	Auto
SM-FUNC-PQ-002	Check voltage sag L1/L2/L3 start and restore. (PPDC, CT, CTPT)	Auto
SM-FUNC-PQ-003	Check voltage swell L1 start and restore. (SP)	Auto
SM-FUNC-PQ-004	Check voltage swell L1/L2/L3 start and restore. (PPDC, CT, CTPT)	Auto
SM-FUNC-PQ-005	Check voltage cut L1 start and restore (SP)	Auto
SM-FUNC-PQ-006	Check voltage cut L1/L2/L3 start and restore (PPDC, CT, CTPT)	Auto
SM-FUNC-PQ-007	Check the default value and load unbalance start and restore (PPDC, CT, CTPT)	Auto
SM-FUNC-PQ-008	Check the default value THD start and restore (CT, CTPT)	Manual
SM-FUNC-PQ-009	Check the default value Export Energy function	Manual

### 3.1.1.1.13 Test Group Load control

Test Group Information			
Test Group ID	SM-FUNC-RC	Test Group Name	Load control
References	<ul style="list-style-type: none"> <li>[1] IESCO_AMI_Project, Technical Specification Smart Meter Companion Specification</li> </ul>		
Test Purpose	<ul style="list-style-type: none"> <li>Checking the control logic of relay management and status</li> </ul>		
Test Setup and Condition	<ul style="list-style-type: none"> <li>Figure 3-2 Meter Function Auto Test Setup</li> </ul>		
Test Method	<ul style="list-style-type: none"> <li>Automated test platform, using the TEST BENCH to add the corresponding load condition and using Auto test Tool to check the relay status and related event</li> </ul>		
Acceptance Criteria	<ul style="list-style-type: none"> <li>The local disconnect and remote disconnect mechanism is correct</li> <li>The result must confirm with [1]</li> <li>All test cases in following list are executed and passed</li> </ul>		
Test Case Lists			
ID	Case Title	Test Type	
SM-FUNC-RC-001	Check the default mode of control mode	Auto	
SM-FUNC-RC-002	Check the default value and function of power limitation (SP, PPDC)	Auto	
SM-FUNC-RC-003	Check the default value and function of power limitation with Auxiliary Disconnect control (CT, CTPT).	Auto	
SM-FUNC-RC-004	Check the remote relay control (SP, PPDC)	Manual	
SM-FUNC-RC-005	Check the remote relay control with Auxiliary Disconnect control (CT, CTPT).	Manual	
SM-FUNC-RC-006	Check the default value and function of over current (SP, PPDC).	Auto	
SM-FUNC-RC-007	Check the default value and function of over current with Auxiliary Disconnect control (CT, CTPT).	Auto	
SM-FUNC-RC-008	Check the default value and function of Demand control function (SP, PPDC).	Auto	
SM-FUNC-RC-009	Check the default value and function of Demand control function with Auxiliary Disconnect control (CT, CTPT).	Auto	

### 3.1.1.1.14 Test Group Firmware upgrade

Test Group Information		
Test Group ID	SM-FUNC-FW	Test Group Name   Firmware upgrade
References	<ul style="list-style-type: none"> <li>[1] IESCO_AMI_Project, Technical Specification Smart Meter Companion Specification</li> <li>[2] DLMS User Association, DLMS UA 1000-1 Ed.14, 2020.</li> </ul>	
Test Purpose	<ul style="list-style-type: none"> <li>Confirming the DUT upgrade process to meet DLMS, the renewal process to meet [2]</li> <li>Confirming that DUT can be upgraded successfully when unconfirmed or confirmed service is used</li> <li>Checking the DUT Data in the metering instrument are not affected in any way by the Firmware update, that including legal-relevant part and non-legal relevant part</li> </ul>	
Test Setup and Condition	<ul style="list-style-type: none"> <li>Figure 3-2 Meter Function Auto Test Setup</li> </ul>	
Test Method	<ul style="list-style-type: none"> <li>Automated test platform, using Auto test Tool to execute upgrading</li> </ul>	
Acceptance Criteria	<ul style="list-style-type: none"> <li>The DUT upgrade process to meet [2]</li> <li>The SM support confirmed and unconfirmed service block transfer block</li> <li>The result must confirm with [1] [2]</li> <li>All test cases in following list are executed and passed</li> </ul>	
Test Case Lists		
ID	Case Title	Test Type
SM-FUNC-FW-001	Advanced version upgrade.	Auto
SM-FUNC-FW-002	Advanced version upgrade with timed activation.	Auto

### 3.1.1.1.15 Test Group Event and status word

Test Group Information		
Test Group ID	SM-FUNC-EVE	Test Group Name   Event and status word
References	<ul style="list-style-type: none"> <li>[1] IESCO_AMI_Project, Technical Specification Smart Meter Companion Specification</li> </ul>	
Test Purpose	<ul style="list-style-type: none"> <li>Checking the correctness of the event detection implementation</li> </ul>	
Test Setup and Condition	<ul style="list-style-type: none"> <li>Figure 3-2 Meter Function Auto Test Setup</li> <li>Figure 3-3 Meter Function Manual Test Setup</li> </ul>	
Test Method	<ul style="list-style-type: none"> <li>Partial automatic test, Partial Manually test, for the test case which cannot be tested automatically, like open cover test</li> </ul>	
Acceptance Criteria	<ul style="list-style-type: none"> <li>The SM can capture the status changed and fraud event in time</li> <li>The event capture time is the same with SM time</li> <li>The result must confirm with [1]</li> <li>All test cases in following list are executed and passed</li> </ul>	
Test Case Lists		
ID	Case Title	Test Type
SM-FUNC-EVE-001 ~ SM-FUNC-EVE-030	Standard event - Event refer to [1]	Auto/Manual
SM-FUNC-EVE-031	Fraud detection event - Event refer to [1]	Auto/Manual

Title:	Interoperability Test Specification	Ver.	2.0	Page:	17 of 103
--------	-------------------------------------	------	-----	-------	-----------

~ SM-FUNC-EVE-080		
SM-FUNC-EVE-081	Relay control event - Event refer to [1]	Auto/Manual
~ SM-FUNC-EVE-110		
SM-FUNC-EVE-111	Power failure event - Event refer to [1]	Auto/Manual
~ SM-FUNC-EVE-120		
SM-FUNC-EVE-121	Power quality event - Event refer to [1]	Auto/Manual
~ SM-FUNC-EVE-130		
SM-FUNC-EVE-131	Communication event - Event refer to [1]	Auto/Manual
~ SM-FUNC-EVE-140		
SM-FUNC-EVE-141	Prepay event - Event refer to [1](SP, PPDC)	Auto/Manual
~ SM-FUNC-EVE-142		
SM-FUNC-EVE-143	Recharge event - Event refer to [1](SP, PPDC)	Auto/Manual
~ SM-FUNC-EVE-155		
SM-FUNC-STA-001	Instantaneous status word - Event refer to [1]	Auto/Manual
~ SM-FUNC-STA-032		
SM-FUNC-STA-033	Tamper status word - Event refer to [1]	Auto/Manual
~ SM-FUNC-STA-037		

### 3.1.1.1.16 Test Group Security function

Test Group Information			
Test Group ID	SM-FUNC-SE	Test Group Name	Security function
References	<ul style="list-style-type: none"> <li>[1] IESCO_AMI_Project, Technical Specification Smart Meter Companion Specification</li> <li>[3] DLMS User Association, DLMS UA 1000-2 Ed.10, 2020.</li> </ul>		
Test Purpose	<ul style="list-style-type: none"> <li>Checking the correctness of key updating</li> <li>Verifying that it is not possible to associate with the wrong Authentication key or Encryption key</li> <li>Verifying that the meter rejects or drops messages with an invalid authentication tag.</li> <li>Checking the security of frame counter connection mechanism</li> </ul>		
Test Setup and Condition	<ul style="list-style-type: none"> <li>Figure 3-2 Meter Function Auto Test Setup</li> </ul>		
Test Method	<ul style="list-style-type: none"> <li>Automated test platform, using Auto test Tool to update key and reconnection to SM with new key and using Auto test Tool to communicate with smaller frame counter</li> </ul>		
Acceptance Criteria	<ul style="list-style-type: none"> <li>The key update mechanism is correct</li> <li>The SM cannot be communicated with smaller frame counter</li> <li>The result must confirm with [1] [3]</li> <li>All test cases in following list are executed and passed</li> </ul>		
Test Case Lists			

Title:	Interoperability Test Specification	Ver.	2.0	Page:	18 of 103
--------	-------------------------------------	------	-----	-------	-----------

ID	Case Title	Test Type
SM-FUNC-SE-001	Clients with different authorities connect to SM	Auto
SM-FUNC-SE-002	Wrong secret keys connect to SM	Auto
SM-FUNC-SE-003	Key change test of Authentication key	Auto
SM-FUNC-SE-004	Key change test of Encryption key	Auto
SM-FUNC-SE-005	Wrong format of frames to connect to SM	Auto

### 3.1.1.1.17 Test Group Optical and RS485 communication

Test Group Information		
Test Group ID	SM-FUNC-COM	Test Group Name   Optical and RS485 communication
References	<ul style="list-style-type: none"> <li>[1] IESCO_AMI_Project, Technical Specification Smart Meter Companion Specification</li> </ul>	
Test Purpose	<ul style="list-style-type: none"> <li>Checking the communication of optical and RS-485</li> </ul>	
Test Setup and Condition	<ul style="list-style-type: none"> <li>Figure 3-2 Meter Function Auto Test Setup</li> </ul>	
Test Method	<ul style="list-style-type: none"> <li>Automated test platform, using Auto test Tool to check the communication of optical and RS-485</li> </ul>	
Acceptance Criteria	<ul style="list-style-type: none"> <li>The result must confirm with [1]</li> <li>All test cases in following list are executed and passed</li> </ul>	
Test Case Lists		
ID	Case Title	Test Type
SM-FUNC-COM-001	Check the communication of optical	Auto
SM-FUNC-COM-002	Check the communication of- RS-485 (CT, CTPT)	Auto

### 3.1.1.1.18 Test Group Prepayment function

Test Group Information		
Test Group ID	SM-FUNC-PM	Test Group Name   Prepayment function
References	<ul style="list-style-type: none"> <li>[1] IESCO_AMI_Project, Technical Specification Smart Meter Companion Specification</li> </ul>	
Test Purpose	<ul style="list-style-type: none"> <li>Checking the post-paid mode is switched to the prepayment mode under normal electricity consumption.</li> <li>Checking the correctness of available credit deduction logic</li> </ul>	
Test Setup and Condition	<ul style="list-style-type: none"> <li>Figure 3-2 Meter Function Auto Test Setup</li> </ul>	
Test Method	<ul style="list-style-type: none"> <li>Automated test platform, using Auto test Tool to switch payment mode and read data related to prepayment and using the TEST BENCH to add the corresponding load condition and using auto test tool check the available credit deduction logic</li> </ul>	
Acceptance Criteria	<ul style="list-style-type: none"> <li>The post-paid mode is switched to the prepayment mode under normal electricity consumption.</li> <li>The available credit deduction logic is correct</li> <li>The result must confirm with [1]</li> <li>All test cases in following list are executed and passed</li> </ul>	
Test Case Lists		
ID	Case Title	Test Type
SM-FUNC-PM-001	Check the logic of mode switch (SP, PPDC)	Auto

Title:	Interoperability Test Specification	Ver.	2.0	Page:	19 of 103
--------	-------------------------------------	------	-----	-------	-----------

SM-FUNC-PM-002	Check the default value of prepayment mode (SP, PPDC)	Auto
SM-FUNC-PM-003	Check the load control status with low credit status and recharge (SP, PPDC)	Auto
SM-FUNC-PM-004	Check the maximum available credit is 99999.999 kWh (SP, PPDC)	Auto
SM-FUNC-PM-005	Check the Available credit deduction in prepayment mode (SP, PPDC)	Auto

### 3.1.1.1.19 Test Group Cellular Communication

Test Group Information		
Test Group ID	SM-FUNC-CELL	Test Group Name Cellular Communication Test
References	<ul style="list-style-type: none"> <li>[1] IESCO_AMI_Project, Technical Specification Smart Meter Companion Specification</li> </ul>	
Test Purpose	<ul style="list-style-type: none"> <li>Checking the default value and capture object data</li> <li>Checking default value, data type, right of the corresponding obis</li> <li>Checking the communication via LTE module is fine.</li> </ul>	
Test Setup and Condition	<ul style="list-style-type: none"> <li>Figure 3-2 Meter Function Auto Test Setup</li> <li>Figure 3-3 Meter Function Manual Test Setup</li> </ul>	
Test Method	<ul style="list-style-type: none"> <li>Partial automatic test</li> </ul>	
Acceptance Criteria	<ul style="list-style-type: none"> <li>The result must confirm with [1]</li> <li>All test cases in following list are executed and passed</li> </ul>	
Test Case Lists		
ID	Case Title	Test Type
SM-FUNC-CELL-001	Check the default values of Cellular module communication parameters	Auto
SM-FUNC-CELL-002	Check the read and write permissions, data type, and size ranges of Cellular module related parameters	Auto
SM-FUNC-CELL-003	Remote connect meter via Cellular communication	Auto
SM-FUNC-CELL-004	Check APN configuration and correct network access	Auto
SM-FUNC-CELL-005	Check PPP configuration and correct network access	Auto
SM-FUNC-CELL-006	Check the network type configuration and correct network access	Manual
SM-FUNC-CELL-007	Check the signal strength display of the LCD module on the electricity meter	Manual
SM-FUNC-CELL-008	Check the process of registering the meter online to the HES	Manual
SM-FUNC-CELL-009	Check the correctness of remote read (including large packets) and write	Auto
SM-FUNC-CELL-010	Check the correctness of the push data process	Manual
SM-FUNC-CELL-011	Check IPv4 and IPv6 network access	Manual
SM-FUNC-CELL-014	Check the hot swappable module and replace module	Manual
SM-FUNC-CELL-015	Remote upgrade of meter	Manual
SM-FUNC-CELL-016	LTE communication module upgrade	Manual
SM-FUNC-CELL-017	Check the module supports PING operation	Auto
SM-FUNC-CELL-018	Check the module supports domain name address resolution	Manual
SM-FUNC-CELL-019	Check the event about LTE communication module	Manual

### 3.1.1.2 IDIS conformance

#### 3.1.1.2.1 Test Suite

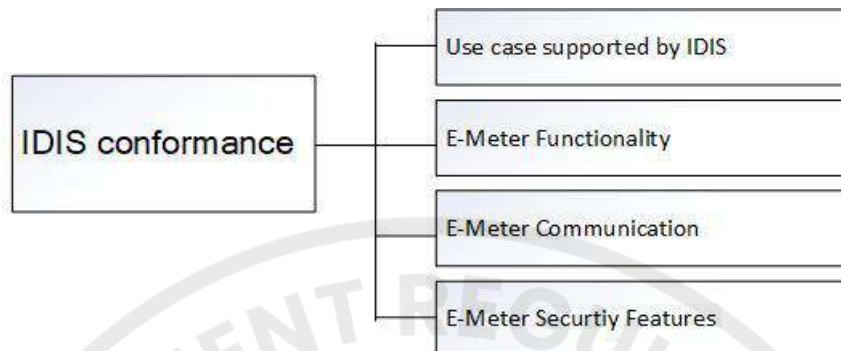

Figure 3-2 Test Groups of IDIS conformance

No.	Test Group ID	Test Group Name
1	SM-IDIS-CASE	Use case supported by IDIS
2	SM-IDIS-FUNC	E-Meter Functionality
3	SM-IDIS-COM	E-Meter Communication
4	SM-IDIS-SE	E-Meter Security Features

Table 3-4 Test Group List of IDIS conformance

#### 3.1.1.2.2 Test Setup

Consistent with section 3.1.1.1.2

#### 3.1.1.2.3 Test Group

Test Group Information			
Test Group ID	SM-IDIS-CASE	Test Group Name	Use case supported by IDIS
References	<ul style="list-style-type: none"> <li>[5] I. I. Association, IDIS INTEROPERABILITY SPECIFICATION PACKAGE 2 IP PROFILE EDITION 2.0, 2014.</li> </ul>		
Test Purpose	<ul style="list-style-type: none"> <li>Checking that basic function and objects of meter comply IDIS</li> </ul>		
Test Setup and Condition	<ul style="list-style-type: none"> <li>Figure 3-2 Meter Function Auto Test Setup</li> </ul>		
Test Method	<ul style="list-style-type: none"> <li>Partial automatic test</li> </ul>		
Acceptance Criteria	<ul style="list-style-type: none"> <li>The result must confirm with [5]</li> <li>All test cases in following list are executed and passed</li> </ul>		
Test Case Lists			
ID	Case Title		Test Type
SM-IDIS-CASE-001	Meter Registration		Manual
SM-IDIS-CASE-002	Remote Tariff Programming		Auto
SM-IDIS-CASE-003	Meter Reading on Demand		Auto
SM-IDIS-CASE-004	Meter Reading for Billing		Auto
SM-IDIS-CASE-005	Meter Clock Synchronization		Auto
SM-IDIS-CASE-006	Firmware Update		Auto

Title:	Interoperability Test Specification	Ver.	2.0	Page:	21 of 103
--------	-------------------------------------	------	-----	-------	-----------

### 3.1.1.2.4 Test Group

Test Group Information		
Test Group ID	SM-IDIS-FUNC	Test Group Name   E-Meter Functionality
References	<ul style="list-style-type: none"> <li>[5] I. I. Association, IDIS INTEROPERABILITY SPECIFICATION PACKAGE 2 IP PROFILE EDITION 2.0, 2014.</li> </ul>	
Test Purpose	<ul style="list-style-type: none"> <li>Checking default value, data type, right of the corresponding obis</li> <li>Confirming the correctness of the data update of the capture object</li> <li>Registering and updating rules</li> <li>Confirming the correctness of data records under normal circumstances</li> </ul>	
Test Setup and Condition	<ul style="list-style-type: none"> <li>Figure 3-2 Meter Function Auto Test Setup</li> </ul>	
Test Method	<ul style="list-style-type: none"> <li>Automated test platform, using Auto test Tool to check the meter functionality</li> </ul>	
Acceptance Criteria	<ul style="list-style-type: none"> <li>The result must confirm with [5]</li> <li>All test cases in following list are executed and passed</li> </ul>	
Test Case Lists		
ID	Case Title	Test Type
SM-IDIS-FUNC-001	Load Profiles- structure and parameter	Auto
SM-IDIS-FUNC-002	Load Profiles- normal read and compressed read	Auto
SM-IDIS-FUNC-003	Load Profiles- Power Down within one capture period	Auto
SM-IDIS-FUNC-004	Load Profiles- Power Down across several capture periods	Auto
SM-IDIS-FUNC-005	Load Profiles- Time changes within capture period	Auto
SM-IDIS-FUNC-006	Load Profiles- Advancing the time over several periods	Auto
SM-IDIS-FUNC-007	Billing profile- Advancing the time over the end of the billing interval	Auto
SM-IDIS-FUNC-008	Billing profile- Setting the time back over the start of billing interval	Auto

### 3.1.1.2.5 Test Group

Test Group Information		
Test Group ID	SM-IDIS-COM	Test Group Name   E-Meter Communication
References	<ul style="list-style-type: none"> <li>[5] I. I. Association, IDIS INTEROPERABILITY SPECIFICATION PACKAGE 2 IP PROFILE EDITION 2.0, 2014.</li> </ul>	
Test Purpose	<ul style="list-style-type: none"> <li>Checking the communication of GPRS and Ethernet and G3-PLC</li> </ul>	
Test Setup and Condition	<ul style="list-style-type: none"> <li>Figure 3-2 Meter Function Auto Test Setup</li> </ul>	
Test Method	<ul style="list-style-type: none"> <li>Automated test platform, using Auto test Tool to check the meter communication</li> </ul>	
Acceptance Criteria	<ul style="list-style-type: none"> <li>The result must confirm with [5]</li> <li>All test cases in following list are executed and passed</li> </ul>	
Test Case Lists		
ID	Case Title	Test Type
SM-IDIS-COM-001	Client and Server Architecture	Auto
SM-IDIS-COM-002	Network Connectivity	Auto
SM-IDIS-COM-003	Lower layers for IP communication- GPRS	Auto

Title:	Interoperability Test Specification	Ver.	2.0	Page:	22 of 103
--------	-------------------------------------	------	-----	-------	-----------

SM-IDIS-COM-004	Lower layers for IP communication- Ethernet	Auto
SM-IDIS-COM-005	Lower layers for IP communication- G3-PLC	Auto

### 3.1.1.2.6 Test Group

Test Group Information		
Test Group ID	SM-IDIS-SE	Test Group Name E-Meter Security Features
References	<ul style="list-style-type: none"> <li>[5] I. I. Association, IDIS INTEROPERABILITY SPECIFICATION PACKAGE 2 IP PROFILE EDITION 2.0, 2014.</li> </ul>	
Test Purpose	<ul style="list-style-type: none"> <li>Checking the rule of key updating</li> <li>Checking the application association establishment</li> <li>Checking the security of frame counter connection mechanism</li> </ul>	
Test Setup and Condition	<ul style="list-style-type: none"> <li>Figure 3-2 Meter Function Auto Test Setup</li> </ul>	
Test Method	<ul style="list-style-type: none"> <li>Automated test platform, using Auto test Tool to check the meter security features</li> </ul>	
Acceptance Criteria	<ul style="list-style-type: none"> <li>The result must confirm with [5]</li> <li>All test cases in following list are executed and passed</li> </ul>	
Test Case Lists		
ID	Case Title	Test Type
SM-IDIS-CASE-001	Security setup object- Security setup	Auto
SM-IDIS-CASE-002	Security setup object -Frame counters	Auto
SM-IDIS-CASE-003	Application association establishment	Auto
SM-IDIS-CASE-004	Using Keys- Rules to change the Key	Auto

### 3.1.2 Cellular Performance Test

Evaluating the LTE signal level transmitted by DUT when it connected with Test Equipment.  
Validate the correct reception of an LTE signal by the DUT for a very low signal level.

#### 3.1.2.1 Test Suite

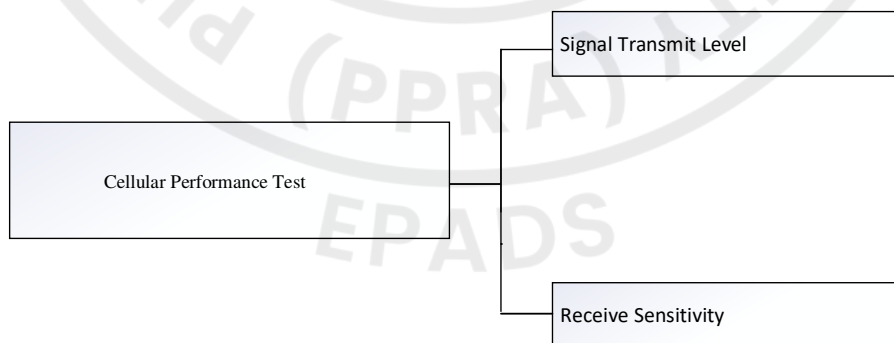

Figure 3-4 Test Group for G3 PLC Module Performance Test

No.	Test Group ID	Test Group Name
1	CELLULAR-PER-STL	Signal Transmit Level
2	CELLULAR-PER-RS	Receive Sensitivity

Table 3-5 Test Group List

### 3.1.2.2 Test Setup

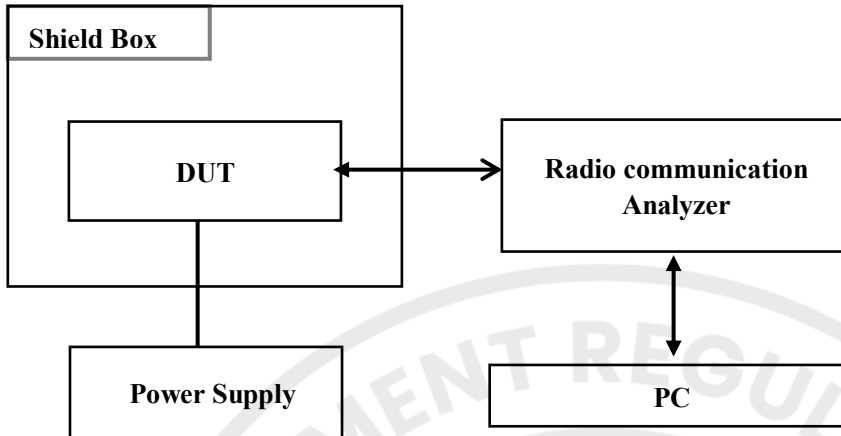

Figure 3-5 Cellular Performance Test Setup

No.	Device	Qty.	Description
1	Radio Communication Analyzer (Comprehensive Tester)	1	<ul style="list-style-type: none"> <li>30 MHz to 3.8 GHz support GPRS/CDMA/LTE communication performance test</li> </ul>
2	Shielding box	1	<ul style="list-style-type: none"> <li>Shield from external interference</li> </ul>
3	PC	1	<ul style="list-style-type: none"> <li>Loading the test configuration, test the wireless case.</li> </ul>

Table 3-6 Device List for Cellular Performance Test

### 3.1.2.3 Test Case Transmitter output power

Test Case Information			
Test Case ID	CELLULAR-PER-STL-001	Test Case Name	Reference sensitivity level test
References	<ul style="list-style-type: none"> <li>[6] 3GPP, 3GPP TS 36.521-1, 2022.</li> </ul>		
Test Purpose	<ul style="list-style-type: none"> <li>Test transmitter test, receiver test and performance test of LTE terminal</li> </ul>		
Test Setup and Condition	<ul style="list-style-type: none"> <li>Figure 3-5 Cellular Performance Test Setup</li> <li>Normal temperature</li> <li>SIM card</li> <li>RF cable</li> </ul>		
Acceptance Criteria	<ul style="list-style-type: none"> <li>The output power meets the standards [6]</li> </ul>		
Procedures	Step No.	Action	Output
	1	Put DUT in the shielding box	
	2	Connect the DUT to the power supply	
	3	Insert SIM card, connect the RF cable	
	4	Connect the DUT to the wireless communication comprehensive tester	
	5	Power on the DUT correctly	
6	Configure the parameters of wireless communication comprehensive tester and connect to the PC		

	7	Open the Test tool , loading the 4G configuration file	
	8	Set the test file name, and start the test	

### 3.1.2.4 Test Case Reference sensitivity level test

Test Case Information			
Test Case ID	CELLULAR-PER-RS-001	Test Case Name	Transmitter output power And Reference sensitivity level test
References	<ul style="list-style-type: none"> <li>[6] 3GPP, 3GPP TS 36.521-1, 2022.</li> </ul>		
Test Purpose	<ul style="list-style-type: none"> <li>Test transmitter test, receiver test and performance test of LTE terminal</li> </ul>		
Test Setup and Condition	<ul style="list-style-type: none"> <li>Figure 3-5 Cellular Performance Test Setup</li> <li>Normal temperature</li> <li>SIM card</li> <li>RF cable</li> </ul>		
Acceptance Criteria	<ul style="list-style-type: none"> <li>The output power meets the standards [6]</li> </ul>		
Procedures	Step No.	Action	Output
	1	Put DUT in the shielding box	
	2	Connect the DUT to the power supply	
	3	Insert SIM card, connect the RF cable	
	4	Connect the DUT to the wireless communication comprehensive tester	
	5	Power on the DUT correctly	
	6	Configure the parameters of wireless communication comprehensive tester and connect to the PC	
	7	Open the Test tool , loading the 4G configuration file	
	8	Set the test file name, and start the test	

### 3.1.3 Integration Test- Cellular Meter to HES(MI2)

This test is designed to verify the integration of the meter with cellular module installed into the HES system.

#### 3.1.3.1 Test Suite

This section divides the Cellular meter and HES integration into multiple groups according to business type.

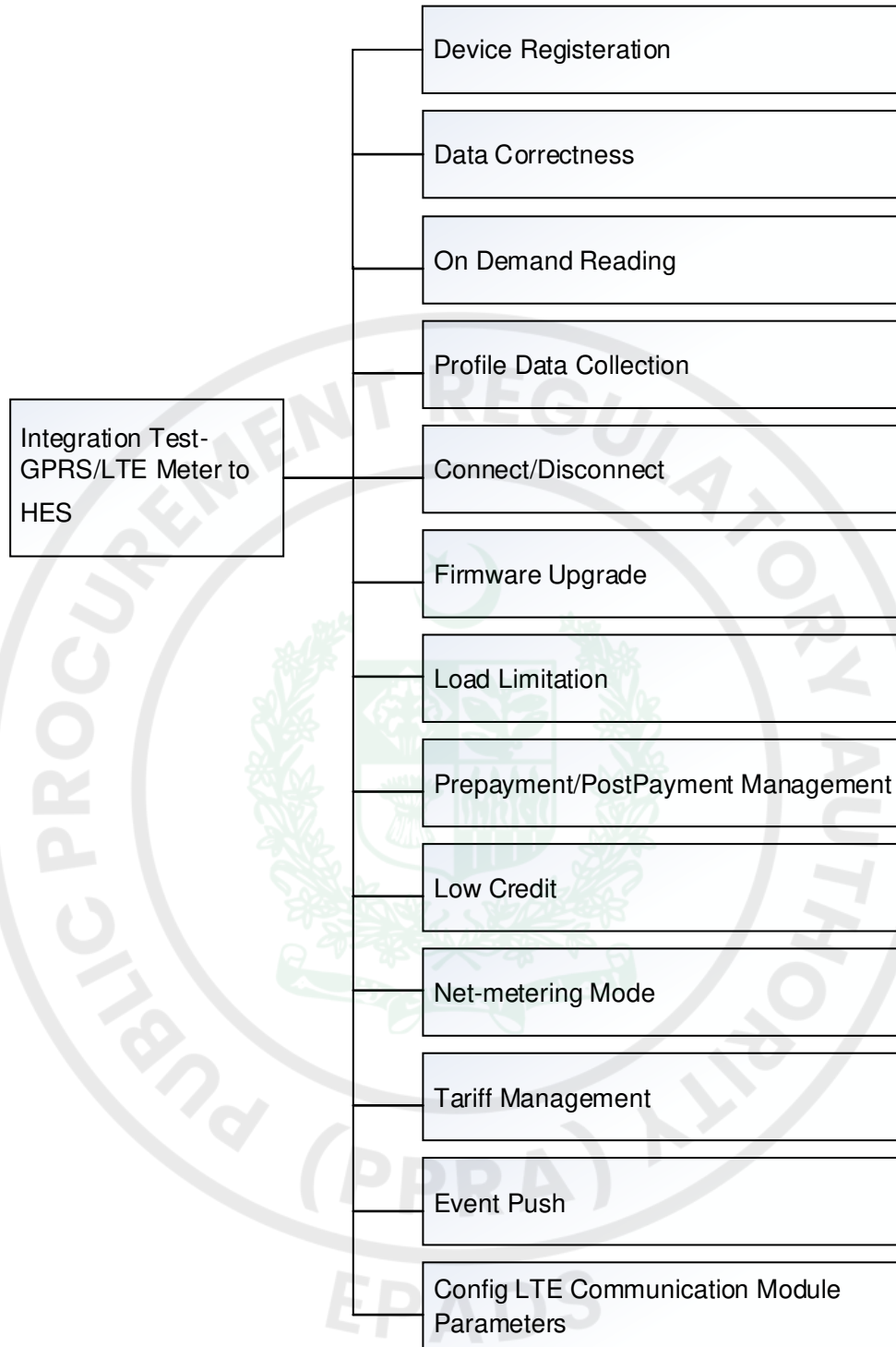

**Figure 3-6 Integration Test-Cellular Meter to HES Test Group**

No.	Test Group ID	Test Group Name
1	SM-INTE-CE-REG	Device Registration
2	SM-INTE-CE-DATA	Data Correctness
3	SM-INTE-CE-ODO	On Demand Operation
4	SM-INTE-CE-DC	Profile Data Collection

No.	Test Group ID	Test Group Name
6	SM-INTE-CE-RC	Remote Control Connect/Disconnect
7	SM-INTE-CE-FU	Firmware Upgrade
8	SM-INTE-CE-LL	Load Limitation
9	SM-INTE-CE-PM	Prepayment/PostPayment Management
10	SM-INTE-CE-LC	Low Credit
11	SM-INTE-CE-NM	Net-metering Mode
12	SM-INTE-CE-TOU	Tariff Management
13	SM-INTE-CE-PUSH	Event Push
14	SM-INTE-CE-CFG	Cellular Communication Module Parameters Configure

Table 3-7 Test Group List for Cellular Meter Integration Test

### 3.1.3.2 Test Setup

The following figure shows the relationship between the components of integration testing.

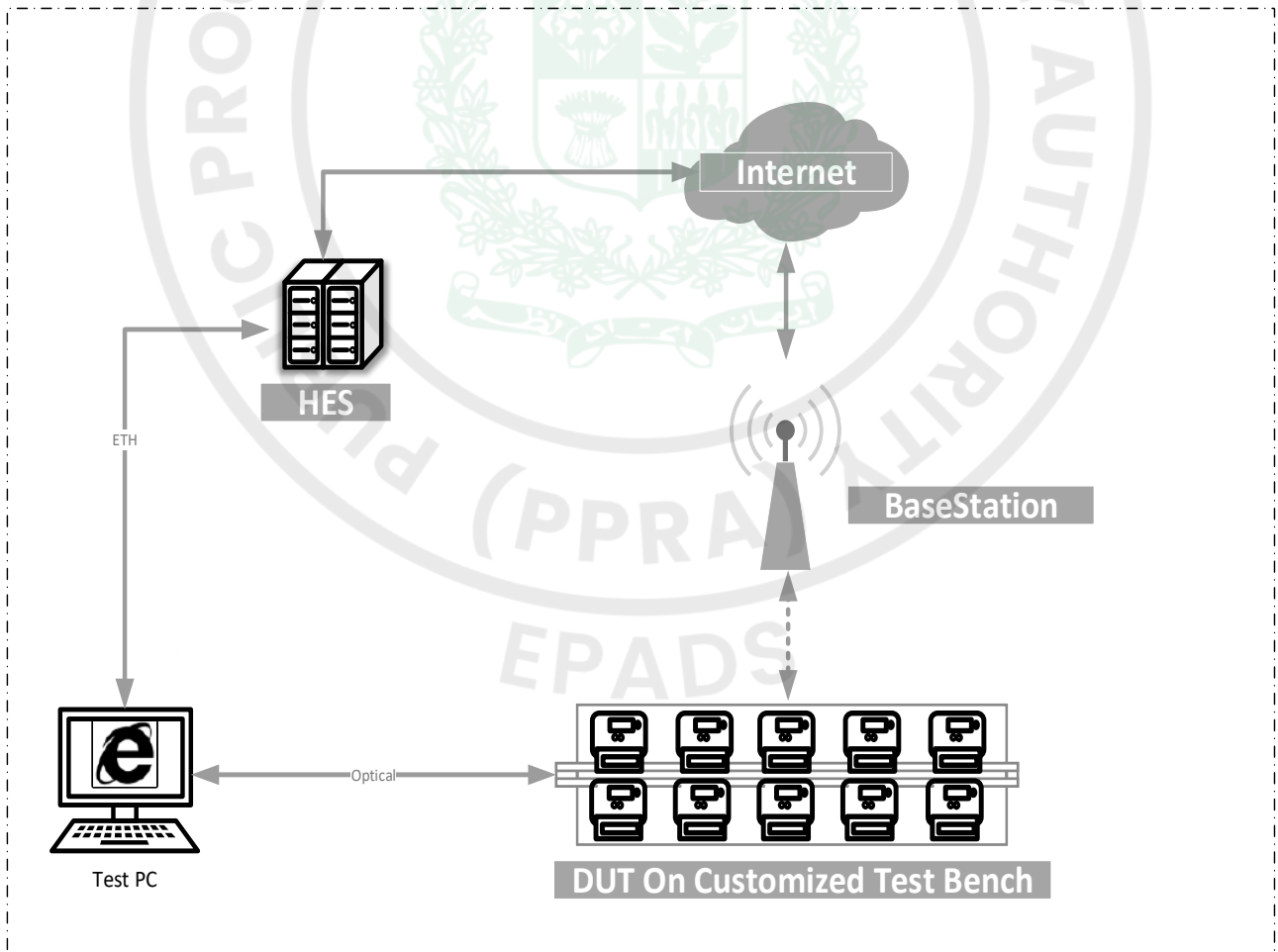

Figure 3-7 Integration Test-Cellular Meter to HES Framework

No.	Device	Qty.	Description
1	HES	1	Head end system
2	Test PC	1	<ul style="list-style-type: none"> <li>Computer</li> <li>PC connect DUT meter via Optical port</li> </ul>
3	DUT	1	Device under test.
4	Customized Test Bench	1	<ul style="list-style-type: none"> <li>Including Customized test bench-control unit and Customized test bench-rack</li> <li>Power the test equipment and support the adjustment of voltage, current, and other parameters to create test conditions.</li> </ul>

**Table 3-8 Device List for Cellular Meter Integration Test**

### 3.1.3.3 Test Group Device Registration

Test Group Information			
Test Group ID	SM-INTE-CE-REG	Test Group Name	Device Registration
References	<ul style="list-style-type: none"> <li>[1] IESCO_AMI_Project, Technical Specification Smart Meter Companion Specification</li> <li>[7] IESCO_AMI_Project, Technical Specification Head End System</li> </ul>		
Test Purpose	Verify meter register to HES.		
Test Setup & Condition	<ul style="list-style-type: none"> <li>All HES services run normally.</li> <li>Communication between the test PC and the server is normal.</li> <li>DUT is communicates normally.</li> </ul>		
Test Method	<ol style="list-style-type: none"> <li>Manually test</li> <li>Power on the DUT</li> <li>Wait the DCU register to HES</li> <li>Check the registered status about DUT in HES</li> </ol>		
Acceptance Criteria	<p>The test cases will result in the following verdicts:</p> <ul style="list-style-type: none"> <li><b>Passed:</b> The interface complies with all the acceptance criteria.</li> <li><b>Failed:</b> The interface does not meet one or more acceptance criteria and needs to be verified after rectification, change points are provided, and relevant test items need to be retested to evaluate.</li> </ul>		
Test Case Lists			
ID	Case Title		
SM-INTE-CE-REG-001	Device Registration Test		

### 3.1.3.4 Test Group Data Correctness

Test Group Information			
Test Group ID	SM-INTE-CE-DATA	Test Group Name	Data Correctness
References	<ul style="list-style-type: none"> <li>[1] IESCO_AMI_Project, Technical Specification Smart Meter Companion Specification</li> <li>[7] IESCO_AMI_Project, Technical Specification Head End System</li> </ul>		
Test Purpose	Verify data correctness during integration		
Test Setup & Condition	<ul style="list-style-type: none"> <li>All HES services run normally.</li> <li>Communication between the test PC and the server is normal.</li> </ul>		

Title:	Interoperability Test Specification	Ver.	2.0	Page:	28 of 103
--------	-------------------------------------	------	-----	-------	-----------

	<ul style="list-style-type: none"> <li>DUT is communicates normally.</li> </ul>
Test Method	<p>Manually test, an example for daily profile:</p> <ol style="list-style-type: none"> <li>Read Daily Profile of the specified date from HES.</li> <li>Read Daily Profile of the specified date from Meter by Optical.</li> <li>Compare two daily settlement data to verify the correctness of the data</li> </ol>
Acceptance Criteria	<p>The test cases will result in the following verdicts:</p> <ul style="list-style-type: none"> <li><b>Passed:</b> The interface complies with all the acceptance criteria.</li> <li><b>Failed:</b> The interface does not meet one or more acceptance criteria and needs to be verified after rectification, change points are provided, and relevant test items need to be retested to evaluate.</li> </ul>
Test Case Lists	
ID	Case Title
SM-INTE-CE-DATA-001	Data Correctness Test

### 3.1.3.5 Test Group on Demand Reading

Test Group Information			
Test Group ID	SM-INTE-CE-ODO	Test Group Name	On Demand Reading
References	<ul style="list-style-type: none"> <li>[1] IESCO_AMI_Project, Technical Specification Smart Meter Companion Specification</li> <li>[7] IESCO_AMI_Project, Technical Specification Head End System</li> </ul>		
Test Purpose	Verify meter reading.		
Test Setup & Condition	<ul style="list-style-type: none"> <li>All HES services run normally.</li> <li>Communication between the test PC and the server is normal.</li> <li>DUT is communicates normally.</li> </ul>		
Test Method	<p>Manually test:</p> <ol style="list-style-type: none"> <li>Read test item from HES.</li> <li>Check the read result.</li> </ol>		
Acceptance Criteria	<p>The test cases will result in the following verdicts:</p> <ul style="list-style-type: none"> <li><b>Passed:</b> The interface complies with all the acceptance criteria.</li> <li><b>Failed:</b> The interface does not meet one or more acceptance criteria and needs to be verified after rectification, change points are provided, and relevant test items need to be retested to evaluate.</li> </ul>		
Test Case Lists			
ID	Case Title		
SM-INTE-CE-ODO-001	Reading Clock Test		
SM-INTE-CE-ODO-002	Reading +A Test		

### 3.1.3.6 Test Group Profile Data Collection

Test Group Information			
Test Group ID	SM-INTE-CE-DC	Test Group Name	Profile Data Collection
References	<ul style="list-style-type: none"> <li>[1] IESCO_AMI_Project, Technical Specification Smart Meter Companion Specification</li> <li>[7] IESCO_AMI_Project, Technical Specification Head End System</li> </ul>		
Test Purpose	Verify data collection during integration		

Test Setup & Condition	<ul style="list-style-type: none"> <li>All HES services run normally.</li> <li>Communication between the test PC and the server is normal.</li> <li>DUT is communicates normally.</li> </ul>
Test Method	<p>Manually test, an example for daily profile:</p> <ol style="list-style-type: none"> <li>Read Daily Profile of the specified date from HES.</li> <li>Check that the collected data is consistent with expectations</li> </ol>
Acceptance Criteria	<p>The test cases will result in the following verdicts:</p> <ul style="list-style-type: none"> <li><b>Passed:</b> The interface complies with all the acceptance criteria.</li> <li><b>Failed:</b> The interface does not meet one or more acceptance criteria and needs to be verified after rectification, change points are provided, and relevant test items need to be retested to evaluate.</li> </ul>
Test Case Lists	
ID	Case Title
SM-INTE-CE-DC -001	Daily Profile Collection Test
SM-INTE-CE-DC -002	Monthly Profile Collection Test
SM-INTE-CE-DC -003	Energy Load Profile Collection Test
SM-INTE-CE-DC -004	Quality Load Profile Collection Test

### 3.1.3.7 Test Group Connect/Disconnect

Test Group Information			
Test Group ID	SM-INTE-CE-RC	Test Group Name	Connect/Disconnect
References	<ul style="list-style-type: none"> <li>[1] IESCO_AMI_Project, Technical Specification Smart Meter Companion Specification</li> <li>[7] IESCO_AMI_Project, Technical Specification Head End System</li> </ul>		
Test Purpose	Verify relay control during integration		
Test Setup & Condition	<ul style="list-style-type: none"> <li>All HES services run normally.</li> <li>Communication between the test PC and the server is normal.</li> <li>DUT is communicates normally.</li> </ul>		
Test Method	<p>Manually test, Take Connected test as an example.</p> <ol style="list-style-type: none"> <li>Connected the meter remotely through HES</li> <li>Check the meter relay status changes to Relay On.</li> </ol>		
Acceptance Criteria	<p>The test cases will result in the following verdicts:</p> <ul style="list-style-type: none"> <li><b>Passed:</b> The interface complies with all the acceptance criteria.</li> <li><b>Failed:</b> The interface does not meet one or more acceptance criteria and needs to be verified after rectification, change points are provided, and relevant test items need to be retested to evaluate.</li> </ul>		
Test Case Lists			
ID	Case Title		
SM-INTE-CE-RC-001	Connected Test		
SM-INTE-CE-RC-002	Disconnected Test		
SM-INTE-CE-RC-003	Read Relay Status Test		

### 3.1.3.8 Test Group Firmware Upgrade

Test Group Information
------------------------

Title:	Interoperability Test Specification	Ver.	2.0	Page:	30 of 103
--------	-------------------------------------	------	-----	-------	-----------

Test Group ID	SM-INTE-CE-FU	Test Group Name	Firmware Upgrade
References	<ul style="list-style-type: none"> <li>[1] IESCO_AMI_Project, Technical Specification Smart Meter Companion Specification</li> <li>[7] IESCO_AMI_Project, Technical Specification Head End System</li> </ul>		
Test Purpose	Verify firm upgrade.		
Test Setup & Condition	<ul style="list-style-type: none"> <li>All HES services run normally.</li> <li>Communication between the test PC and the server is normal.</li> <li>DUT is communicates normally.</li> <li>Firm file is uploaded to HES.</li> </ul>		
Test Method	Manually test 1. Create upgrade task from HES. 2. Wait the task run finished. 3. Check the result of the upgrade task, and check the version of the DUT		
Acceptance Criteria	The test cases will result in the following verdicts: <ul style="list-style-type: none"> <li><b>Passed:</b> The interface complies with all the acceptance criteria.</li> <li><b>Failed:</b> The interface does not meet one or more acceptance criteria and needs to be verified after rectification, change points are provided, and relevant test items need to be retested to evaluate.</li> </ul>		
<b>Test Case Lists</b>			
ID	Case Title		
SM-INTE-CE-FU -001	Meter Upgrade Test		
SM-INTE-CE-FU -002	Cellular Module Upgrade Test		

### 3.1.3.9 Test Group Load Limitation

<b>Test Group Information</b>			
Test Group ID	SM-INTE-CE-LL	Test Group Name	Load Limitation
References	<ul style="list-style-type: none"> <li>[1] IESCO_AMI_Project, Technical Specification Smart Meter Companion Specification</li> <li>[7] IESCO_AMI_Project, Technical Specification Head End System</li> </ul>		
Test Purpose	Verify Load Limitation during integration		
Test Setup & Condition	<ul style="list-style-type: none"> <li>All HES services run normally.</li> <li>Communication between the test PC and the server is normal.</li> <li>DUT is communicates normally.</li> </ul>		
Test Method	Manually test 1. Read Load Limitation by HES. 2. Change the Load Limitation to another value by HES. 3. Read Load Limitation again, and check the read value is the same as the value set in the previous step.		
Acceptance Criteria	The test cases will result in the following verdicts: <ul style="list-style-type: none"> <li><b>Passed:</b> The interface complies with all the acceptance criteria.</li> <li><b>Failed:</b> The interface does not meet one or more acceptance criteria and needs to be verified after rectification, change points are provided, and relevant test items need to be retested to evaluate.</li> </ul>		
<b>Test Case Lists</b>			
ID	Case Title		

Title:	Interoperability Test Specification	Ver.	2.0	Page:	31 of 103
--------	-------------------------------------	------	-----	-------	-----------

SM-INTE-CE-LL -001	Read Load Limitation Test
SM-INTE-CE-LL -002	Change Load Limitation Test

### 3.1.3.10 Test Group Prepayment/Post Payment Management

Test Group Information			
Test Group ID	SM-INTE-CE-PM	Test Group Name	Prepayment/PostPayment Management
References	<ul style="list-style-type: none"> <li>[1] IESCO_AMI_Project, Technical Specification Smart Meter Companion Specification</li> <li>IESCO_AMI_Project, Technical Specification Head End System</li> </ul>		
Test Purpose	Verify payment management during integration		
Test Setup & Condition	<ul style="list-style-type: none"> <li>All HES services run normally.</li> <li>Communication between the test PC and the server is normal.</li> <li>DUT is communicates normally.</li> </ul>		
Test Method	Manually test 1. Read Payment Mode by HES. 2. Change the Payment mode to another mode by HES. 3. Read Payment Mode again, and check the read value is different with the value read in the first step.		
Acceptance Criteria	The test cases will result in the following verdicts: <ul style="list-style-type: none"> <li><b>Passed:</b> The interface complies with all the acceptance criteria.</li> <li><b>Failed:</b> The interface does not meet one or more acceptance criteria and needs to be verified after rectification, change points are provided, and relevant test items need to be retested to evaluate.</li> </ul>		
Test Case Lists			
ID	Case Title		
SM-INTE-CE-PM -001	Prepayment Changed Test		
SM-INTE-CE-PM -002	Post Payment Changed Test		
SM-INTE-CE-PM -003	Read Payment Mode Test		

### 3.1.3.11 Test Group Low Credit

Test Group Information			
Test Group ID	SM-INTE-CE-LC	Test Group Name	Low Credit
References	<ul style="list-style-type: none"> <li>[1] IESCO_AMI_Project, Technical Specification Smart Meter Companion Specification</li> <li>[7] IESCO_AMI_Project, Technical Specification Head End System</li> </ul>		
Test Purpose	Verify payment management during integration		
Test Setup & Condition	<ul style="list-style-type: none"> <li>All HES services run normally.</li> <li>Communication between the test PC and the server is normal.</li> <li>DUT is communicates normally.</li> </ul>		
Test Method	Manually test 1. Read Low Credit by HES. 2. Change the Low Credit to another value by HES. 3. Read Low Credit value again, and check the read value is the same as the value set in the previous step.		
Acceptance Criteria	The test cases will result in the following verdicts:		

	<ul style="list-style-type: none"> <li>• <b>Passed:</b> The interface complies with all the acceptance criteria.</li> <li>• <b>Failed:</b> The interface does not meet one or more acceptance criteria and needs to be verified after rectification, change points are provided, and relevant test items need to be retested to evaluate.</li> </ul>
Test Case Lists	
ID	Case Title
SM-INTE-CE-LC -001	Read Low Credit Test
SM-INTE-CE-LC -002	Change Low Credit Test

### 3.1.3.12 Test Group Net-metering Mode

Test Group Information			
Test Group ID	SM-INTE-CE-NM	Test Group Name	Net-metering Mode
References	<ul style="list-style-type: none"> <li>• [1] IESCO_AMI_Project, Technical Specification Smart Meter Companion Specification</li> <li>• [7] IESCO_AMI_Project, Technical Specification Head End System</li> </ul>		
Test Purpose	Verify payment management during integration		
Test Setup & Condition	<ul style="list-style-type: none"> <li>• All HES services run normally.</li> <li>• Communication between the test PC and the server is normal.</li> <li>• DUT is communicates normally.</li> </ul>		
Test Method	Manually test 1. Read Net-metering Mode by HES. 2. Change the Net-metering Mode to another value by HES. 3. Read Net-metering Mode again, and check the read value is the same as the value set in the previous step.		
Acceptance Criteria	The test cases will result in the following verdicts: <ul style="list-style-type: none"> <li>• <b>Passed:</b> The interface complies with all the acceptance criteria.</li> <li>• <b>Failed:</b> The interface does not meet one or more acceptance criteria and needs to be verified after rectification, change points are provided, and relevant test items need to be retested to evaluate.</li> </ul>		
Test Case Lists			
ID	Case Title		
SM-INTE-CE-NM -001	Change Net-metering Mode Test		

### 3.1.3.13 Test Group Tariff Management

Test Group Information			
Test Group ID	SM-INTE-CE-TOU	Test Group Name	Tariff Management
References	<ul style="list-style-type: none"> <li>• [1] IESCO_AMI_Project, Technical Specification Smart Meter Companion Specification</li> <li>• [7] IESCO_AMI_Project, Technical Specification Head End System</li> </ul>		
Test Purpose	Verify tariff management during integration		
Test Setup & Condition	<ul style="list-style-type: none"> <li>• All HES services run normally.</li> <li>• Communication between the test PC and the server is normal.</li> <li>• DUT is communicates normally.</li> </ul>		
Test Method	Manually test		

	<ol style="list-style-type: none"> <li>1. Read tariff by HES.</li> <li>2. Change the tariff to other value by HES.</li> <li>3. Read tariff again, and check the read value is different with the value read in the first step.</li> </ol>
Acceptance Criteria	<p>The test cases will result in the following verdicts:</p> <ul style="list-style-type: none"> <li>• <b>Passed:</b> The interface complies with all the acceptance criteria.</li> <li>• <b>Failed:</b> The interface does not meet one or more acceptance criteria and needs to be verified after rectification, change points are provided, and relevant test items need to be retested to evaluate.</li> </ul>
Test Case Lists	
ID	Case Title
SM-INTE-CE-TOU-001	Read Tariff Test
SM-INTE-CE-TOU-002	Change Tariff Test

### 3.1.3.14 Test Group Event Push

Test Group Information			
Test Group ID	SM-INTE-CE-PUSH	Test Group Name	Event Push
References	<ul style="list-style-type: none"> <li>• [1] IESCO_AMI_Project, Technical Specification Smart Meter Companion Specification</li> <li>• [7] IESCO_AMI_Project, Technical Specification Head End System</li> </ul>		
Test Purpose	Verify event push during integration		
Test Setup & Condition	<ul style="list-style-type: none"> <li>• All HES services run normally.</li> <li>• Communication between the test PC and the server is normal.</li> <li>• DUT is communicates normally.</li> </ul>		
Test Method	<p>Manually test</p> <ol style="list-style-type: none"> <li>1. Trigger the meter to report a specific event.</li> <li>2. Wait 5 minutes and check if HES received the event</li> </ol>		
Acceptance Criteria	<p>The test cases will result in the following verdicts:</p> <ul style="list-style-type: none"> <li>• <b>Passed:</b> The interface complies with all the acceptance criteria.</li> <li>• <b>Failed:</b> The interface does not meet one or more acceptance criteria and needs to be verified after rectification, change points are provided, and relevant test items need to be retested to evaluate.</li> </ul>		
Test Case Lists			
ID	Case Title		
SM-INTE-CE-PUSH-001	Event Push Test		

### 3.1.3.15 Test Group Configure LTE Communication Module Parameters

Test Group Information			
Test Group ID	SM-INTE-CE-CFG	Test Group Name	Config LTE Communication Module Parameters
References	<ul style="list-style-type: none"> <li>• [1] IESCO_AMI_Project, Technical Specification Smart Meter Companion Specification</li> <li>• [7] IESCO_AMI_Project, Technical Specification Head End System</li> </ul>		
Test Purpose	Verify module config during integration		

Title:	Interoperability Test Specification	Ver.	2.0	Page:	34 of 103
--------	-------------------------------------	------	-----	-------	-----------

Test Setup & Condition	<ul style="list-style-type: none"> <li>All HES services run normally.</li> <li>Communication between the test PC and the server is normal.</li> <li>DUT is communicates normally.</li> </ul>
Test Method	<p>Manually test, Take read IP as an example</p> <ol style="list-style-type: none"> <li>Read IP by HES.</li> <li>Check the read result is consistent with expected</li> </ol>
Acceptance Criteria	<p>The test cases will result in the following verdicts:</p> <ul style="list-style-type: none"> <li><b>Passed:</b> The interface complies with all the acceptance criteria.</li> <li><b>Failed:</b> The interface does not meet one or more acceptance criteria and needs to be verified after rectification, change points are provided, and relevant test items need to be retested to evaluate.</li> </ul>
<b>Test Case Lists</b>	
ID	Case Title
SM-INTE-CE-CFG-001	Read Module IP Test



## 3.2 E-Meter with PLC Communication

For E-Meter with G3 PLC Communication, the following tests must be conducted to ensure compatibility and seamless integration with other devices specified in the IESCO AMI Project.

- STEP1 Basic Function Compliance Test
  - E-Meter Functional Test
  - G3 PLC Performance Test
- STEP2 Integration Test-G3 PLC Meter to DCU/HES(MI1)
- STEP3 Real Environment Simulation Test

The DUT samples and reports/certificate should be provided by meter supplier.

Item	Device	Qty.	Provider	Description
1	DUT Sample	300	Meter Supplier	<ul style="list-style-type: none"> <li>• 1pcs for Function Test</li> <li>• 1pcs for G3 PLC Performance Test</li> <li>• 6pcs for Integration Test</li> <li>• 273pcs for Real Enviroment SimulationTest</li> <li>• 9pcs backup</li> </ul>
2	DLMS Certification	1	Meter Supplier	DLMS Protocol certificate (CTT4.3)
3	G3-PLC Certification	1	Meter Supplier	G3-PLC certification for the communication module or the platform used by the module
4	Firmware update file	1	Meter Supplier	DUT firmware File for upgrade testing
5	DUT Test Report	1	Meter Supplier	<ul style="list-style-type: none"> <li>• Type test report</li> <li>• Software test report</li> </ul>
6	Shipmen file	1	Meter Supplier	Include secret keys of different clients
7	Tool	-	Meter Supplier	Software testing tool offered by different manufacturers to support local/remote connection and operation with DUT

Table 3-9 DUT Requirements for E-Meter with Cellular Communication

### 3.2.1 E-Meter Functional Test

Due to the differences only in the communication modules between the PLC Meter and the Cellular communication meter, the rest of the functions are identical, this chapter only describes the newly added test content related to PLC Meter, the rest is consistent with chapter 3.1.1

#### 3.2.1.1 Test Suite

This section only describes the newly added test group related to PLC Meter; the rest is consistent with section 3.1.1.1

No.	Test Group ID	Test Group Name
1	SM-FUNC-PLC	PLC communication

Table 3-10 Test Group Added for PLC Meter

### 3.2.1.2 Test Setup

Consistent with section 3.1.1.1.2

### 3.2.1.3 Test Group G3 PLC function

Test Group Information			
Test Group ID	SM-FUNC-PLC	Test Group Name	G3 PLC function
References	<ul style="list-style-type: none"> <li>[1] IESCO_AMI_Project, Technical Specification Smart Meter Companion Specification Section 7</li> <li>[4] IESCO_AMI_Project, dlms_obis_list</li> <li>[2] DLMS User Association, DLMS UA 1000-1 Ed.14, 2020.</li> <li>[8] ITU-T, “ITU-T G.9903: Narrowband orthogonal frequency division multiplexing power line communication transceivers for G3-PLC networks,” ITU, 2017.</li> </ul>		
Test Purpose	<ul style="list-style-type: none"> <li>Checking default value, data type, right of the corresponding obis.</li> <li>Checking the key configuration is valid.</li> <li>Checking communication via G3 PLC module is fine.</li> <li>Checking the key feature of G3 PLC works well.</li> </ul>		
Test Setup and Condition	<ul style="list-style-type: none"> <li>Figure 3-2 Meter Function Auto Test Setup</li> </ul>		
Test Method	Partial automatic test, Partial Manually test <ul style="list-style-type: none"> <li>Using auto test tool to compare the G3 default value, data type, right of the corresponding obis</li> <li>Ping the meter’s IPv6 address to verify the ICMPv6</li> <li>Checking communication via G3 PLC module is fine</li> <li>Triger the RREQ&amp;PREQ process, to verify the process works well</li> <li>Manual test: PLC Related LED, LCD</li> </ul>		
Acceptance Criteria	<ul style="list-style-type: none"> <li>All the test cases are pass</li> </ul>		
Test Case Lists			
ID	Case Title		
SM-FUNC-PLC-001	Check ID-P value in bootstrapping process		
SM-FUNC-PLC-002	Check G3 PLC meter register Process (bootstrapping, route discovery)		
SM-FUNC-PLC-003	ICMPv6 test		
SM-FUNC-PLC-004	Remote connect meter via PLC communication		
SM-FUNC-PLC-005	RREQ/RREP		
SM-FUNC-PLC-006	PREQ/PREP		
SM-FUNC-PLC-007	Kick Off		
SM-FUNC-PLC-007	Communication success rate test		
SM-FUNC-PLC-008	G3 PLC timeout timer test		
SM-FUNC-PLC-009	Verify the key feature configuration		
SM-FUNC-PLC-010	Default parameter setting for Keep-Alive		
SM-FUNC-PLC-011	Keep-Alive process test		
SM-FUNC-PLC-012	G3-PLC Network Management		
SM-FUNC-PLC-013	G3 PLC Communication LED indicator		

### 3.2.2 PLC Performance Test

This test aims to focus on the signal transmission level and receive sensitivity of the PLC communication module.

The PLC module should have good transmission level with load or without load, sensitive signal receive ability, resistance to noise damage. So that the PLC module can have a better communication success rate, stronger switch, and more original coverage in real-world environments.

### 3.2.2.1 Test Suite

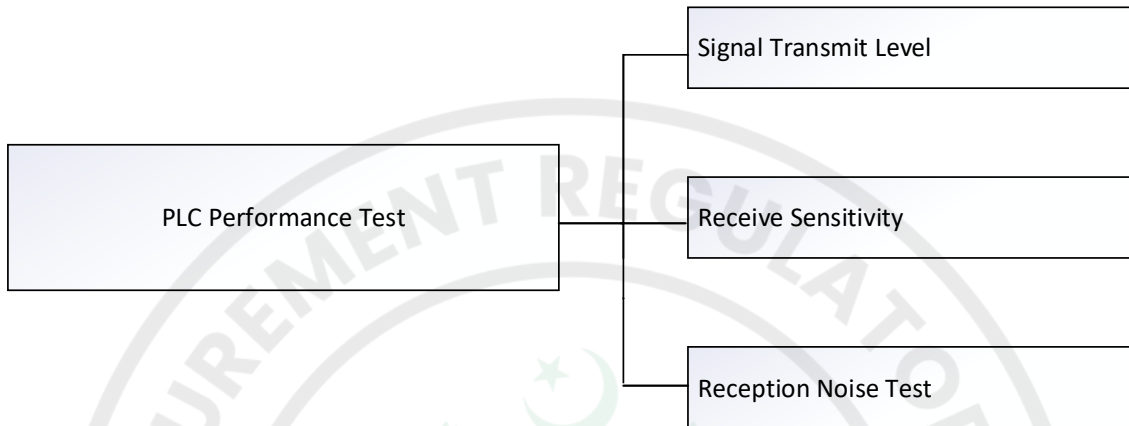

Figure 3-8 Test Group for G3 PLC Module Performance Test

No.	Test Group ID	Test Group Name
1	PLC-PER-STL	Signal Transmit Level
2	PLC-PER-RS	Receive Sensitivity
3	PLC-PER-RNT	Reception Noise Test

Table 3-11 Test Group List

### 3.2.2.2 Test Setup

#### 3.2.2.2.1 Test Setup Signal Transmit Level

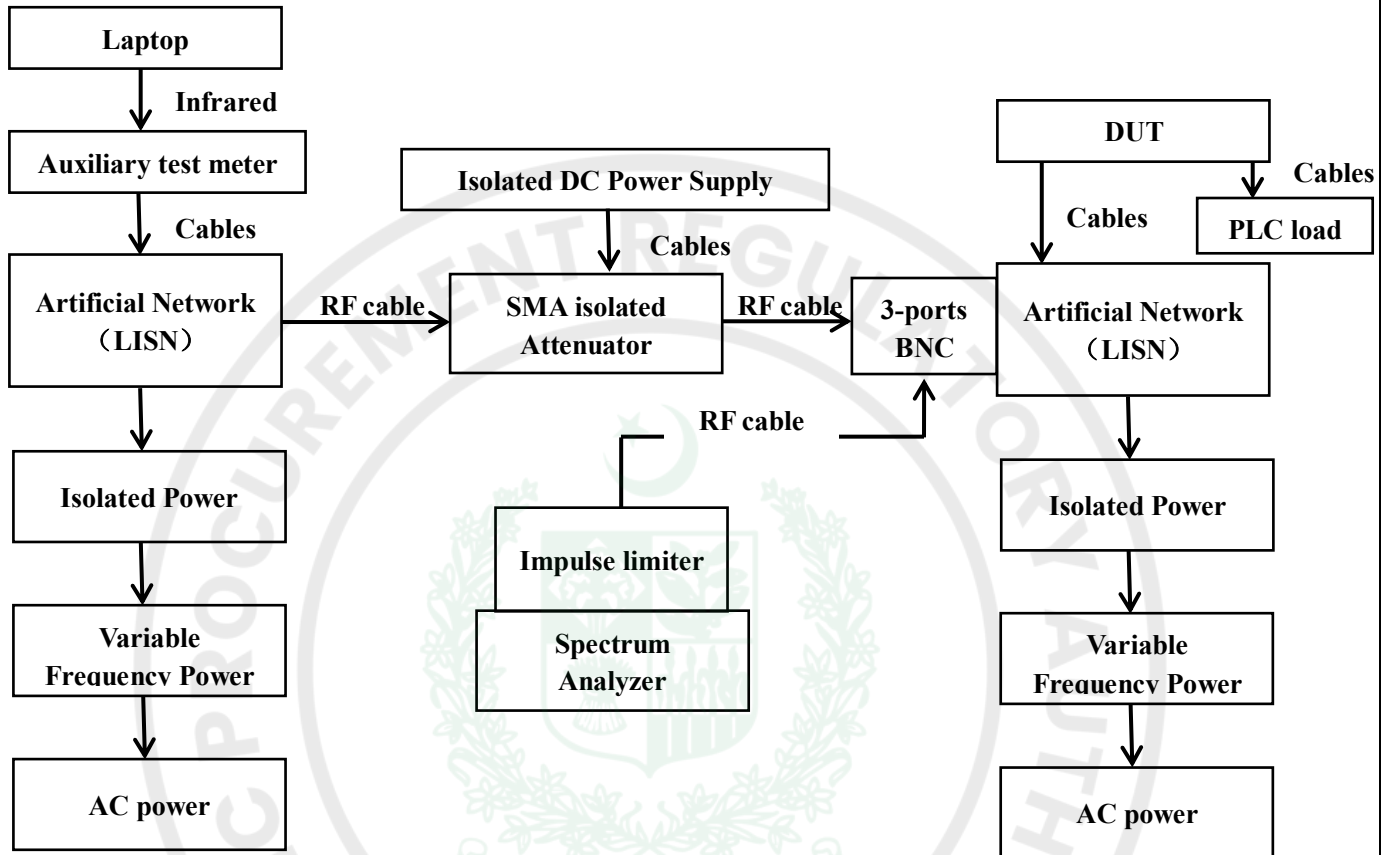
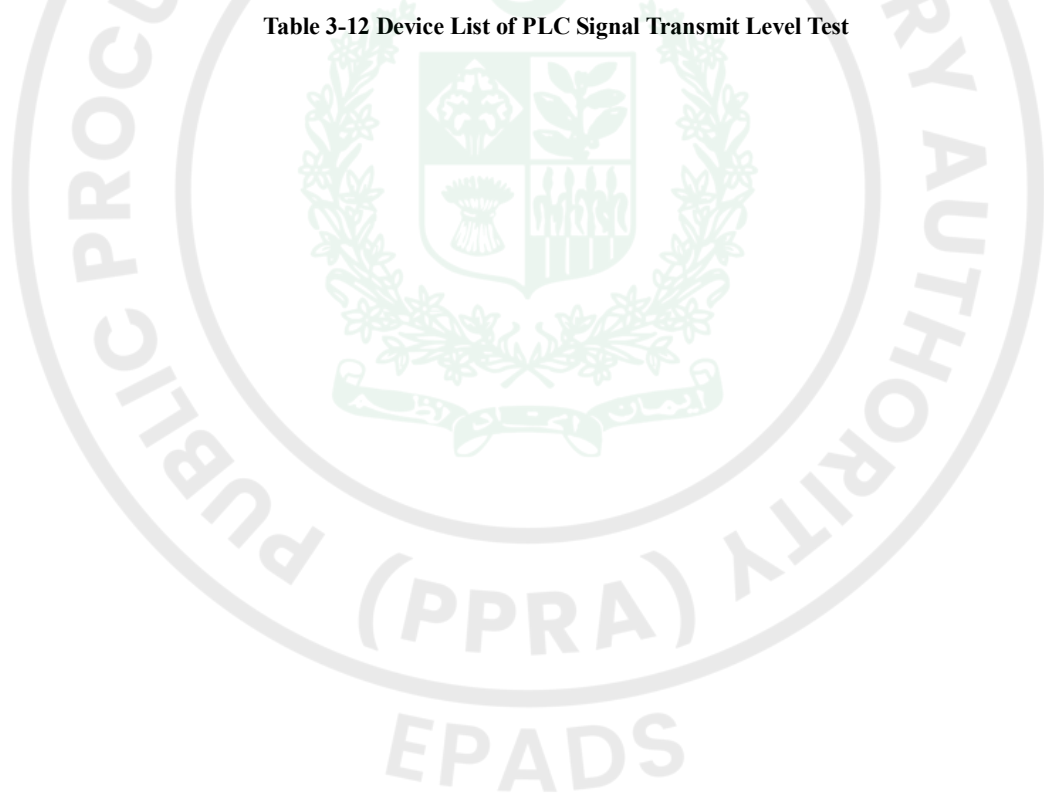

Figure 3-9 Test Setup for PLC Signal Transmit Level Test

No.	Device	Qty.	Description
1	Variable Frequency Power Supply	2	AC power input, output stable 230V 50Hz power, to avoid AC voltage change. Recommended model: ANFC015T
2	Isolated Power	2	Isolate AC power and meter power supply, to avoid PLC signal transmission through AC power, without pass the LISN and Attenuator.
3	Artificial Network (LISN)	2	Isolate AC power and PLC signal. Output PLC signal. Recommended model: NSLK 8126
4	SMA isolated Attenuator	1	Attenuated PLC signal.
5	Spectrum Analyzer	1	Measure PLC signal level.
6	Impulse limiter	1	Filter DC signal and attenuated signal, protect Spectrum Analyzer.

No.	Device	Qty.	Description
7	Isolated DC Power Supply	1	Power to SMA isolated Attenuator.
8	RF cable	3	Connect cable, connect SMA isolated Attenuator to Spectrum Analyzer
9	Laptop	1	Communicate DUT and Auxiliary test meter
10	Auxiliary test meter	1	Communicate with DUT, send data to DUT, receive data from DUT
11	3-ports BNC	1	Connector, connect Spectrum Analyzer and SMA isolated Attenuator and Artificial Network (LISN)
12	2Ω PLC LOAD	1	Add load at PLC signal.

**Table 3-12 Device List of PLC Signal Transmit Level Test**



### 3.2.2.2.2 Test Setup Receive sensitivity

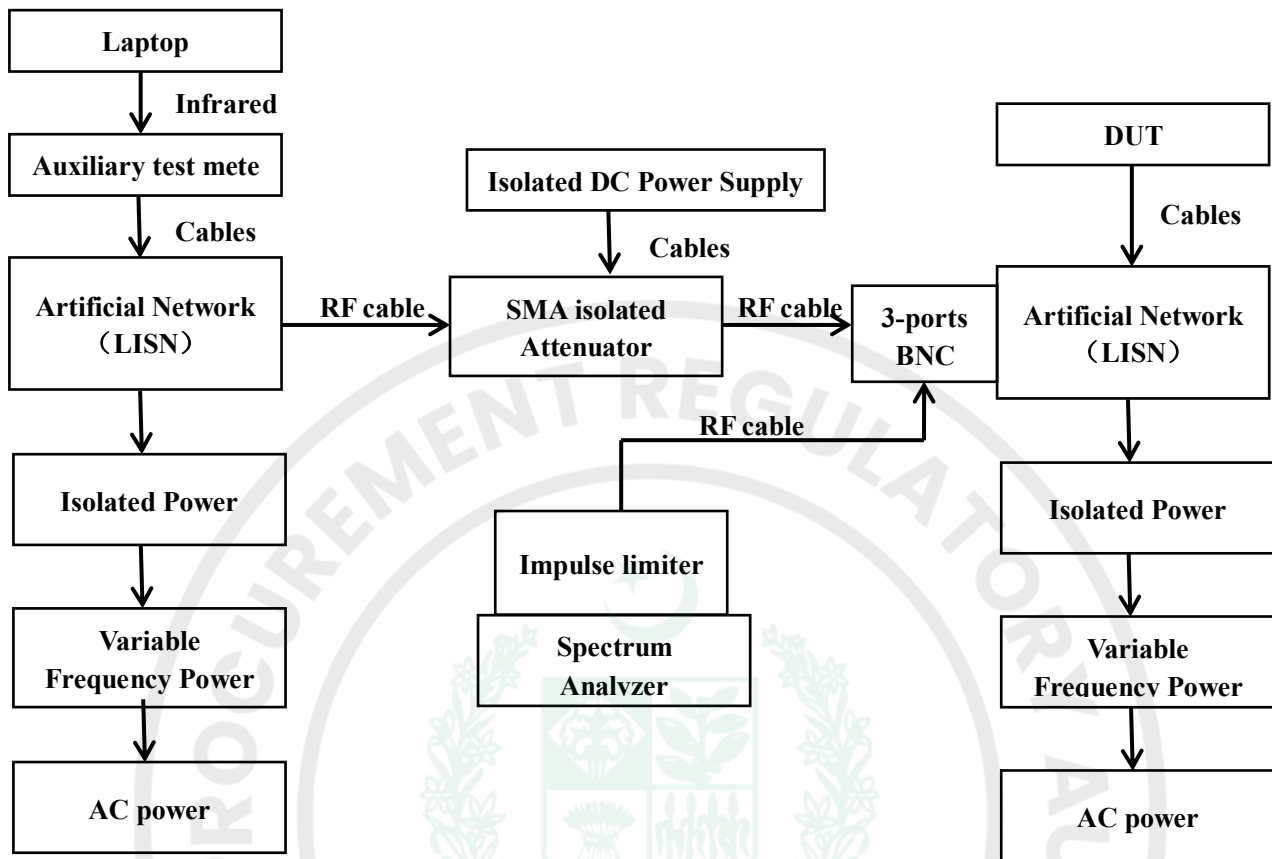

Figure 3-10 Test Setup for PLC Receive Sensitivity Test

No.	Device	Qty.	Description
1	Variable Frequency Power Supply	2	AC power input, output stable 230V 50Hz power, to avoid AC voltage change. Recommended model: ANFC015T
2	Isolated Power	2	Isolate AC power and meter power supply, to avoid PLC signal transmission through AC power, without pass the LISN and Attenuator
3	Artificial Network (LISN)	2	Isolate AC power and PLC signal. Output PLC signal
4	SMA isolated Attenuator	1	Attenuated PLC signal
5	Spectrum Analyzer	1	Measure PLC signal level
6	Impulse limiter	1	Filter DC signal and attenuated signal, protect Spectrum Analyzer
7	Isolated DC Power Supply	1	Power to SMA isolated Attenuator

No.	Device	Qty.	Description
8	RF cable	3	Connect cable, connect SMA isolated Attenuator to Spectrum Analyzer
9	Laptop	1	Communicate DUT and Auxiliary test meter
10	Auxiliary test meter	1	Communicate with DUT, send data to DUT, receive data from DUT
11	3-ports BNC	1	Connector, connect Spectrum Analyzer and SMA isolated Attenuator and Artificial Network (LISN)

Table 3-13 Device List of PLC Receive Sensitivity Test

### 3.2.2.2.3 Test Setup Reception Noise Test

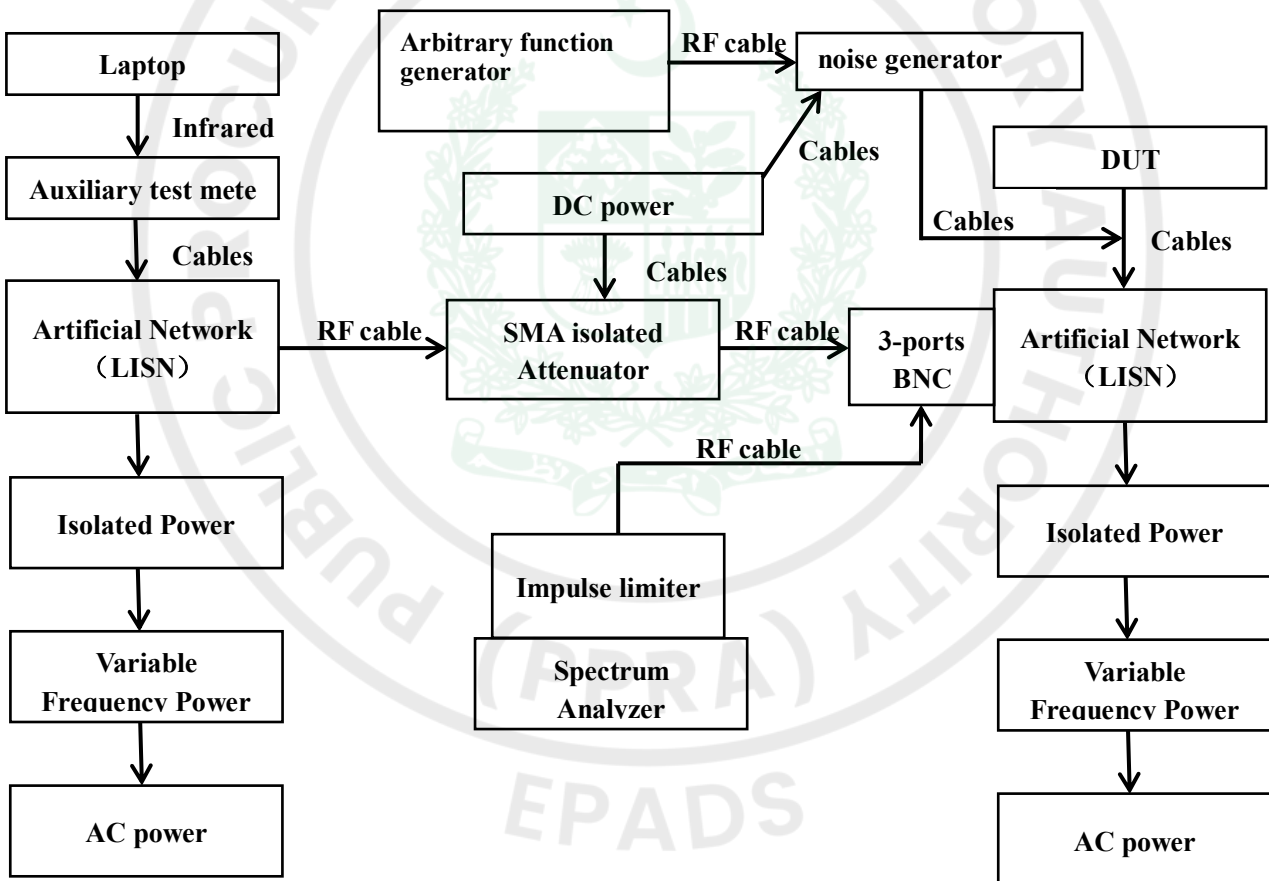

Figure 3-11 Test Setup for PLC Reception Noise Test

No.	Device	Qty.	Description
1	Variable Frequency Power Supply	2	AC power input, output stable 230V 50Hz power, to avoid AC voltage change. Recommended model: ANFC015T

No.	Device	Qty.	Description
2	Isolated Power	2	Isolate AC power and meter power supply, to avoid PLC signal transmission through AC power, without pass the LISN and Attenuator
3	Artificial Network (LISN)	2	Isolate AC power and PLC signal. Output PLC signal
4	SMA isolated Attenuator	1	Attenuated PLC signal
5	Spectrum Analyzer	1	Measure PLC signal level
6	Impulse limiter	1	Filter DC signal and attenuated signal, protect Spectrum Analyzer
7	DC power	1	Power to SMA isolated Attenuator
8	RF cable	3	Connect cable, connect SMA isolated Attenuator to Spectrum Analyzer
9	Laptop	1	Communicate DUT and Auxiliary test meter
10	Auxiliary test meter	1	Communicate with DUT, send data to DUT, receive data from DUT
11	3-ports BNC	1	Connector, connect Spectrum Analyzer and SMA isolated Attenuator and Artificial Network (LISN)
12	Arbitrary function generator	1	Injecting a continuous sinusoidal noise signal. Recommended model: AFG 31000
13	Noise generator	1	Connect Arbitrary function generator, magnification noise signal, and output noise signal to AC power

**Table 3-14 Device List of PLC Reception Noise Test**

EPADS

### 3.2.2.3 Signal Transmit Level.

This test aims to focus on the signal transmission level with load or without load, The PLC signal power whether strong, It can transmit PLC signal in different environments. And this level is within the standard requirements. The test References is ITU-T G.9901 at 7 Transmitted output voltage specifications relating to the 148.5 kHz–535 kHz band.

The supplier of the device under test needs to confirm that it meets the following requirements.

Test DUT: Conform to “Performance-Test-Specification-for-G3-PLC-Certification” at “1.3 Functional requirement on the DUT”. Conform to “G3-PLC-Alliance-Conformance-Tests-Specification-v0.37” at “2.4 ICMPv6 and UDP responder”

#### 3.2.2.3.1 Test Case signal transmit level with LISN load 50Ω

Test Case Information									
Test Case ID	PLC-PER-STL-001	Test Case Name	signal transmit level with LISN load 50Ω						
References	<ul style="list-style-type: none"> <li>[9] CENELEC, “EN 50065-1: Signalling on low-voltage electrical installations in the frequency range 3 kHz to 148.5 kHz - Part 1: General requirements, frequency bands and electromagnetic disturbances,” CENELEC, 2011.section 6.3.1.2 b) Wide band signals:</li> <li>[8] ITU-T, “ITU-T G.9903: Narrowband orthogonal frequency division multiplexing power line communication transceivers for G3-PLC networks,” ITU, 2017.section 7 Transmitted output voltage specifications relating to the 148.5 kHz–535 kHz band</li> </ul>								
Test Purpose	<ul style="list-style-type: none"> <li>The level is within the standard requirements.</li> </ul>								
Test Setup and Condition	<ul style="list-style-type: none"> <li>Test Temperature:20~25°C</li> <li>Test Power: Provides the rated voltage required by the equipment datasheet</li> <li>Test Environment:Figure 3-9 Test Setup for PLC Signal Transmit Level Test</li> <li>Test DUT: Conform to [10] section 1.3 Functional requirement on the DUT and [11] section 2.4 ICMPv6 and UDP responder</li> </ul>								
Acceptance Criteria	<ul style="list-style-type: none"> <li>The maximum level is not more than 137dBuv at RBW 100kHz, and maximum level is not more than 120dBuv at RBW 200Hz</li> </ul> <table border="1"> <thead> <tr> <th>RBW</th> <th>Limit(dBuv)</th> </tr> </thead> <tbody> <tr> <td>100kHz</td> <td>137</td> </tr> <tr> <td>200Hz</td> <td>120</td> </tr> </tbody> </table>			RBW	Limit(dBuv)	100kHz	137	200Hz	120
RBW	Limit(dBuv)								
100kHz	137								
200Hz	120								
Procedures	Step No.	Action	Output						
	1	Test Environment : Conform to 6.1.1.4 without PLC load							
	2	Power on, the Variable Frequency Power Supply set 230V 50Hz, then output. c set 230V, then output. DC power set 5V, then output.							
	3	Auxiliary test meter and DUT power on.							
	4	SMA isolated attenuator set 25dB attenuator							
5	Power on Spectrum Analyzer, Set spectrometer mode. Set center frequency 321093.75Hz. set span 371250Hz. Set occupied bandwidth 328125Hz. Set RBW 200Hz. Set sweep times auto. Set unit is dBuv. Set Max vertical position:132dbuv, set external attenuation: -xxdB								

		(Conform Impulse limiter). Set sweep is single sweep. Trace configuration set clear. Set detector type is max peak.	
6		Power on laptop, connect auxiliary test meter by infrared. Open “PLC Signal Transmit Level test” on test tool, the test tool will show “start send 01”. The auxiliary test meter will send data to DUT.	Test app at laptop show “start send 01”
7		The DUT receive 0x01 will send 0x02. So the Spectrum Analyzer test DUT sends 0x02 data voltage level.	
8		Set trace configuration is max-hold of the Spectrum Analyzer in spectrometer mode Wait 3 minutes, the test tool will show “end send”, The Spectrum Analyzer in spectrometer mode will record plc signal transmit waveform.	Record plc signal transmit waveform
9		Check integrity of the plc signal transmit waveform.	
10		Set mark point is max point in FCC frequency (154.6875kHz~487.5kHz). Record the max point at what frequency and what level. Record the plc signal transmit waveform photo.	Maximum level(dBuv)
11		Set trace configuration is clear of the Spectrum Analyzer in spectrometer mode, Set RBW is 100KHz	
12		Repeat step 6 to 10	
13		End, Power off	

### 3.2.2.3.2 Test Case PLC signal transmit level with PLC load 2Ω

Test Case Information															
Test Case ID	PLC-PER-STL-002	Test Case Name	Test PLC signal transmit level with PLC load 2Ω												
References	<ul style="list-style-type: none"> <li>[10] G.-P. Alliance, G3-PLC Alliance - Performance Test Specification, V1.0 , G3-PLC Alliance, 2022. Section 2.1 PERF_PHY_001_SIGNAL_INJECTION_LISN_2_Ohms</li> </ul>														
Test Purpose	<ul style="list-style-type: none"> <li>The PLC signal power is strong at load. It can transmit PLC signal in different environments.</li> </ul>														
Test Setup and Condition	<ul style="list-style-type: none"> <li>Test Temperature:20~25°C</li> <li>Test Power: Provides the rated voltage required by the equipment datasheet</li> <li>Test Enviroment:Figure 3-9 Test Setup for PLC Signal Transmit Level Test</li> <li>Test DUT: Conform to [10] section 1.3 Functional requirement on the DUT and [11] section 2.4 ICMPv6 and UDP responder</li> </ul>														
Acceptance Criteria	<ul style="list-style-type: none"> <li>The maximum level is not more than 137dBuv at RBW 100kHz, and maximum level is not more than 120dBuv at RBW 200kHz</li> </ul> <table border="1"> <thead> <tr> <th>RBW</th> <th>Maximum level(dBuv)</th> <th>Limit(dBuv)</th> <th>Result (Pass/Fail)</th> </tr> </thead> <tbody> <tr> <td>100kHz</td> <td></td> <td>137</td> <td></td> </tr> <tr> <td>200Hz</td> <td></td> <td>120</td> <td></td> </tr> </tbody> </table> <ul style="list-style-type: none"> <li>Compare the results of test group 1 and test group 2. Should be not more than 12 dB lower at lisen load and 2Ω PLC load. The level more close , the PLC signal</li> </ul>			RBW	Maximum level(dBuv)	Limit(dBuv)	Result (Pass/Fail)	100kHz		137		200Hz		120	
RBW	Maximum level(dBuv)	Limit(dBuv)	Result (Pass/Fail)												
100kHz		137													
200Hz		120													

	more strong.				
	RBW	Maximum level(dBuv) at lisen load	Maximum level(dBuv) at 2Ω PLC load	level at lisen load subtract level at 2Ω PLC load	Result (Pass/Fail)
	100kHz				
200Hz					

Procedures	Step No.	Action	Output
	1	Test Environment: Conform to 6.1.1.4 with PLC load	
	2	Power on, the Variable Frequency Power Supply set 230V 50Hz, then output. Isolated Power set 230V, then output. DC power set 5V, then output.	
	3	Auxiliary test meter and DUT power on.	
	4	SMA isolated attenuator set 25dB attenuator	
	5	Power on Spectrum Analyzer, Set spectrometer mode. Set center frequency 321093.75Hz. set span 371250Hz. Set occupied bandwidth 328125Hz. Set RBW 200Hz. Set sweep times auto. Set unit is dBuv. Set Max vertical position:132dbuv, Set external attenuation: -xxdB(Conform Impulse limiter). Set sweep is single sweep. Trace configuration set clear. Set detector type is max peak.	
	6	Power on laptop, connect auxiliary test meter by infrared. Open “PLC Signal Transmit Level test” on test tool, the test tool will show “start send 01”. The auxiliary test meter will send data to DUT.	
	7	The DUT receive 0x01 will send 0x02. So the Spectrum Analyzer test DUT send 0x02 data voltage level.	
	8	Set trace configuration is max-hold of the Spectrum Analyzer in spectrometer mode Wait 3 minutes, the test tool will show “end send”, The Spectrum Analyzer in spectrometer mode will record plc signal transmit waveform.	Record plc signal transmit waveform
	9	Check integrality of the plc signal transmit waveform.	
	10	Set mark point is max point in FCC frequency (154.6875kHz~487.5kHz). Record the max point at what frequency and what level. Record the plc signal transmit waveform photo.	Maximum level(dBuv)
	11	Set trace configuration is clear of the Spectrum Analyzer in spectrometer mode, Set RBW is 100KHz	
	12	Repeat step 6 to 10	
13	End, Power off		

### 3.2.2.4 Receive sensitivity

This test aims to verify the smallest PLC signal which can be received by PLC module. The smaller the PLC signal level that the PLC module can receive, the better communication success rate and stronger switch network

the PLC module has. The test Refer to G3-PLC Alliance - Performance Test Specification at 2.8  
PERF\_PHY\_008\_PHY\_RX\_SENSITIVITY

### 3.2.2.5 Test Case Receive sensitivity at 60dBuv signal level

Test Case Information														
Test Case ID	PLC-PER-RS-001	Test Case Name	Receive sensitivity at 60dBuv signal level											
References	<ul style="list-style-type: none"> <li>[10] G.-P. Alliance, G3-PLC Alliance - Performance Test Specification, V1.0 , G3-PLC Alliance, 2022. Section 2.8, PERF_PHY_008_PHY_RX_SENSITIVITY.</li> </ul>													
Test Purpose	<ul style="list-style-type: none"> <li>The receive level is within the standard requirements.</li> </ul>													
Test Setup and Condition	<ul style="list-style-type: none"> <li>Test Temperature:20~25°C</li> <li>Test Power: Provides the rated voltage required by the equipment datasheet</li> <li>Test Environment: Figure 3-10 Test Setup for PLC Receive Sensitivity Test, AC power have not extra noise.</li> <li>Test DUT: Conform to [10] section 1.3 Functional requirement on the DUT and [11] section 2.4 ICMPv6 and UDP responder</li> </ul>													
Acceptance Criteria	<ul style="list-style-type: none"> <li>Indicate the signal level of a 60dBuv that can be received correctly by the DUT (with FER &lt;5%)</li> </ul> <table border="1"> <thead> <tr> <th>RBW</th> <th>Maximum level(dBuv)</th> <th>Limit(dBuv)</th> <th>FER (%)</th> <th>Result (Pass/Fail)</th> </tr> </thead> <tbody> <tr> <td>200Hz</td> <td></td> <td>60</td> <td></td> <td></td> </tr> </tbody> </table>				RBW	Maximum level(dBuv)	Limit(dBuv)	FER (%)	Result (Pass/Fail)	200Hz		60		
RBW	Maximum level(dBuv)	Limit(dBuv)	FER (%)	Result (Pass/Fail)										
200Hz		60												
Procedures	Step No.	Action		Output										
	1	Test Environment: Conform to 5.1.2.2												
	2	Power on, the Variable Frequency Power Supply set 230V 50Hz, then output. Isolated Power set 230V, than output. DC power set 5V, than output.												
	3	Auxiliary test meter power on, The DUT power off.												
	4	SMA isolated attenuator set 25dB attenuator												
	5	Power on Spectrum Analyzer, Set spectrometer mode. Set center frequency 321093.75Hz. set span 371250Hz. Set occupied bandwidth 328125Hz. Set RBW 200Hz. Set sweep times auto. Set unit is dBuv. Set Max vertical position:132dbuv, Set external attenuation: -xxdB (Conform Impulse limiter). Set sweep is single sweep. Trace configuration set clear. Set detector type is max peak.												
	6	Power on laptop, connect auxiliary test meter by infrared. Open “PLC Receive sensitivity test” on test tool, the test tool will show “start send 02”. The auxiliary test meter will send data to DUT. The auxiliary test meter sends signal level reduced output gain -12dB.		Test app at laptop show “start send 02”										
7	Set trace configuration is max-hold of the Spectrum Analyzer in spectrometer mode Wait 1 minutes, the test tool will show “end send 02”, The Spectrum Analyzer in spectrometer mode will record plc signal transmit		Record plc signal transmit waveform											

		waveform.	
	8	Check integrality of the plc signal transmit waveform.	
	9	Set mark point is max point in FCC frequency (154.6875kHz~487.5kHz). Record the max point at what frequency and what level. Record the plc signal transmit waveform photo.	Maximum level(dBuv)
	10	Check integrality of the plc signal transmit waveform. Retest step 6~9-unit SMA isolated attenuator set xxdB attenuator the maximum level is 60dBuv.	
	11	Keep the SMA isolated attenuator set, The DUT power on. Remove RF cable SMA-BNC of connect Spectrum Analyzer with 3-ports BNC	
	12	Power on laptop, connect auxiliary test meter by infrared. Open "PLC Receive sensitivity test" on test tool, the test tool will show "start send 02". The auxiliary test meter will send data to DUT 100 times. The auxiliary test meter sends signal level reduced output gain -12dB.	
	13	The DUT receive 0x01 will send 0x02. The Auxiliary test meter will receive the DUT send 0x02. And the Auxiliary test meter will calculate what times of receive data.	the test tool will show FER
	14	End test, power off	

### 3.2.2.6 Test Case Receive sensitivity at minimum signal level

Test Case Information														
Test Case ID	PLC-PER-RS-002	Test Case Name	Receive sensitivity at minimum signal level											
References	<ul style="list-style-type: none"> <li>[10] G.-P. Alliance, G3-PLC Alliance - Performance Test Specification, V1.0 , G3-PLC Alliance, 2022. Section 2.8, PERF_PHY_008_PHY_RX_SENSITIVITY.</li> </ul>													
Test Purpose	<ul style="list-style-type: none"> <li>The receive level is within the standard requirements.</li> </ul>													
Test Setup and Condition	<ul style="list-style-type: none"> <li>Test Temperature:20~25°C</li> <li>Test Power: Provides the rated voltage required by the equipment datasheet</li> <li>Test Environment: Figure 3-10 Test Setup for PLC Receive Sensitivity Test, AC power have not extra noise.</li> <li>Test DUT: Conform to [10] section 1.3 Functional requirement on the DUT and [11] section 2.4 ICMPv6 and UDP responder</li> </ul>													
Acceptance Criteria	<ul style="list-style-type: none"> <li>Indicate the signal level of a xxdBuv that can be received correctly by the DUT (with FER &lt;5%)</li> </ul> <table border="1"> <thead> <tr> <th>RBW</th> <th>Maximum level(dBuv)</th> <th>Limit(dBuv)</th> <th>FER (%)</th> <th>Result (Pass/Fail)</th> </tr> </thead> <tbody> <tr> <td>200Hz</td> <td></td> <td>60</td> <td>&lt;5%</td> <td></td> </tr> </tbody> </table>				RBW	Maximum level(dBuv)	Limit(dBuv)	FER (%)	Result (Pass/Fail)	200Hz		60	<5%	
RBW	Maximum level(dBuv)	Limit(dBuv)	FER (%)	Result (Pass/Fail)										
200Hz		60	<5%											
Procedures	Step No.	Action		Output										
	1	Test Environment: Conform to 5.1.2.2												
	2	Power on, the Variable Frequency Power Supply set 230V 50Hz, then output. Isolated Power set 230V, then output. DC power set 5V, then output.												

	3	Auxiliary test meter power on, The DUT power off.	
	4	SMA isolated attenuator set 25dB attenuator	
	5	Remove RF cable SMA-BNC of connect Spectrum Analyzer with 3-ports BNC	
	6	SMA isolated attenuator set “The signal level of a 60dBuv that can be received correctly by the DUT” case set, The DUT power on.	
	7	Power on laptop, connect auxiliary test meter by infrared. Open “PLC Receive sensitivity test” on test tool, the test tool will show “start send 02”. The auxiliary test meter will send data to DUT 100 times. The auxiliary test meter sends signal level reduced output gain -12dB.	
	8	The DUT receive 0x01 will send 0x02. The Auxiliary test meter will receive the DUT send 0x02. And the Auxiliary test meter will calculate what times of receive data.	
	9	Add the attenuator value unit received correctly by the DUT with FER <5%. Keep the attenuator value	Record the test tool will show FER and the attenuator value
	10	Connect RF cable SMA-BNC of connect Spectrum Analyzer with 3-ports BNC	
	11	Power on Spectrum Analyzer, Set spectrometer mode. Set center frequency 321093.75Hz. set span 371250Hz. Set occupied bandwidth 328125Hz. Set RBW 200Hz. Set sweep times auto. Set unit is dBuv. Set Max vertical position:132dbuv, Set external attenuation: -xxdB(Conform Impulse limiter). Set sweep is single sweep. Trace configuration set clear. Set detector type is max peak.	
	12	Open “PLC Receive sensitivity test” on test tool, the test tool will show “start send 02”. The auxiliary test meter will send data to DUT 100 times. The auxiliary test meter send signal level reduced output gain -12dB.	
	13	Set trace configuration is max-hold of the Spectrum Analyzer in spectrometer mode Wait 1 minutes, the test tool will show “end send 02”, The Spectrum Analyzer in spectrometer mode will record plc signal transmit waveform.	
	14	Check integrality of the plc signal transmit waveform.	
	15	Set mark point is max point in FCC frequency (154.6875kHz~487.5kHz). Record the max point at what frequency and what level. Record the plc signal transmit waveform photo.	Maximum level(dBuv)
	16	End, power off	

### 3.2.2.7 Reception noise test

This test aims to focus on the DUT can correct reception of a frame by the DUT in presence of a narrow band noise. The DUT can work ROBO modulation and transmit data on the affected carriers to immune carriers. The test References is G3-PLC Alliance - Performance Test Specification at 2.4  
PERF\_PHY\_004\_SIGNAL\_RECEPTION\_NARROW\_BAND\_NOISE

### 3.2.2.8 Test Case Reception noise test

Test Case Information			
Test Case ID	PLC-PER-RNT-001	Test Case Name	Reception noise test
References	<ul style="list-style-type: none"> <li>[10] G.-P. Alliance, G3-PLC Alliance - Performance Test Specification, V1.0 , G3-PLC Alliance, 2022. Section 2.4 PERF_PHY_004_SIGNAL_RECEPTION_NARROW_BAND_NOISE</li> </ul>		
Test Purpose	<ul style="list-style-type: none"> <li>The DUT can correct reception of a frame by the DUT in presence of a narrow band noise.</li> </ul>		
Test Setup And Condition	<ul style="list-style-type: none"> <li>Test Temperature:20~25°C</li> <li>Test Power: Provides the rated voltage required by the equipment datasheet</li> <li>Test Environment: Figure 3-11 Test Setup for PLC Reception Noise Test</li> </ul>		
Acceptance Criteria	<ul style="list-style-type: none"> <li>The SNR at -20dB level that can be received correctly by the DUT (with FER &lt;5%)</li> </ul>		
Procedures	Step No.	Action	Output
	1	Test Environment: Conform to 5.1.2.2	
	2	Power on, the Variable Frequency Power Supply set 230V 50Hz, then output. Isolated Power set 230V, then output. DC power set 5V, then output.	
	3	Auxiliary test meter power on, The DUT power off.	
	4	SMA isolated attenuator set 25dB attenuator	
	5	Power on Spectrum Analyzer, Set spectrometer mode. Set center frequency 321093.75Hz. set span 371250Hz. Set occupied bandwidth 328125Hz. Set RBW 200Hz. Set sweep times auto. Set unit is dBuv. Set Max vertical position:132dbuv, set external attenuation: -xxdB(Conform Impulse limiter). Set sweep is single sweep. Trace configuration set clear. Set detector type is max peak.	
	6	Power on laptop, connect auxiliary test meter by infrared. Open “PLC Receive sensitivity test” on test tool, the test tool will show “start send 03”. The auxiliary test meter will send data to DUT. The auxiliary test meter sends signal level reduced output gain -12dB.	
	7	Set trace configuration is max-hold of the Spectrum Analyzer in spectrometer mode Wait 1 minutes, the test tool will show “end send 03”, The Spectrum Analyzer in spectrometer mode will record plc signal transmit waveform.	

	8	Check integrity of the plc signal transmit waveform at Spectrum Analyzer	
	9	Set mark point is max point in FCC frequency (154.6875kHz~487.5kHz). Record the max point at what frequency and what level. Record the plc signal transmit waveform photo.	
	10	Check integrity of the plc signal transmit waveform. Retest step 6~9-unit SMA isolated attenuator set xxdB attenuator the mark point maximum level is 60dBuv.	
	11	Keep the SMA isolated attenuator set, The DUT power on.	
	12	Power on Arbitrary function generator AFG 31000 and KF noise generator. Set AFG 31000, continuous sinusoidal signal, frequency is 300kHz, Vpp is 0.1V, than output	
	13	Check integrity of the noise signal transmit waveform and set Vpp is xxV by AFG 31000 unit the mark point maximum level is 86dBuv. So the SNR is -20dB	
	14	Keep Arbitrary function generator AFG 31000 setting	
	15	Connect auxiliary test meter by infrared. Open “PLC Receive sensitivity test” on test tool, the test tool will show “start send 03”. The auxiliary test meter will send data to DUT 100 times. The auxiliary test meter send signal level reduced output gain -12dB.	
	16	The test tool will show FER	The test tool will show FER
	17	End test, power off	

### 3.2.3 Integration Test-G3 PLC Meter to DCU/HES (MI1)

This test aims to detect if there is any failures or errors of integration test-G3 PLC meter to DCU/HES.

### 3.2.3.1 Test Suite

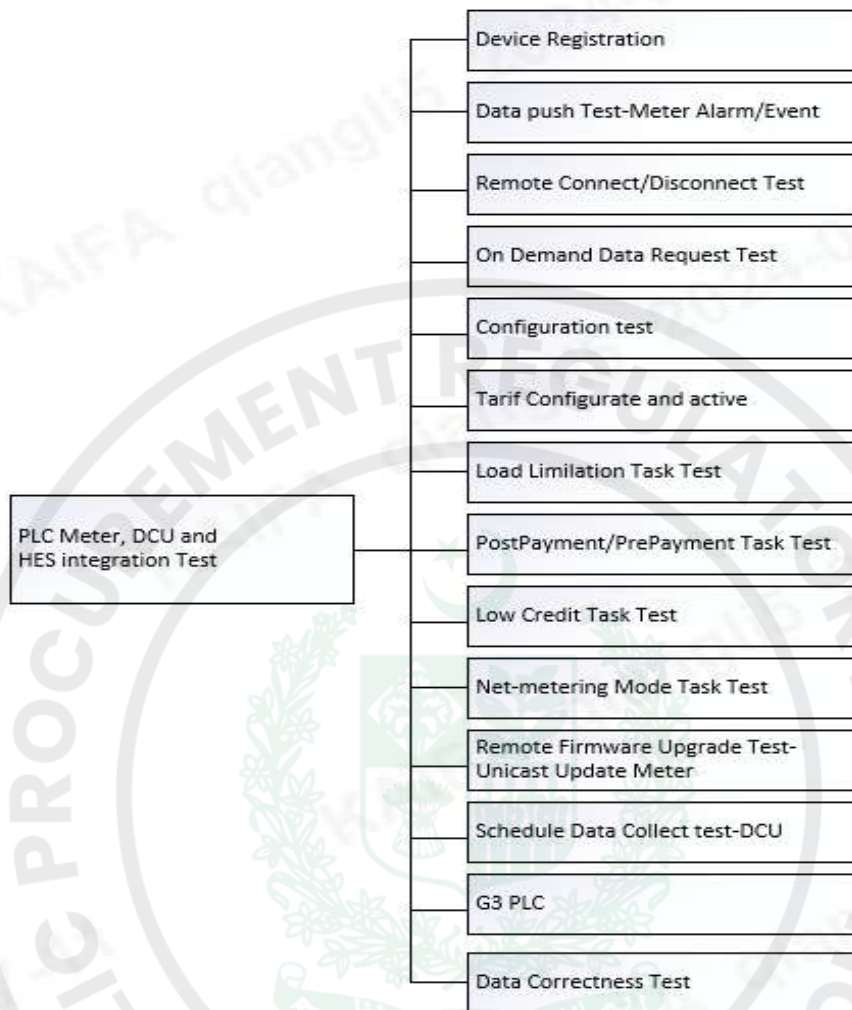

Figure 3-12 Test Groups for PLC Meter Integration Test

No.	Test Group ID	Test Group Name
1	SM-INTE-PLC-REG	Device Registration
2	SM-INTE-PLC-PUSH	Data push Test-Meter Alarm/Event
3	SM-INTE-PLC-RC	Remote Connect/Disconnect Test
4	SM-INTE-PLC-ODO	On Demand Operation Test
5	SM-INTE-PLC-CFG	Configuration test
6	SM-INTE-PLC-TOU	Tariff Management
7	SM-INTE-PLC-LL	Load Limitation Task Test
8	SM-INTE-PLC-PM	Post Payment/Prepayment Task Test
9	SM-INTE-PLC-LC	Low Credit Task Test
10	SM-INTE-PLC-NM	Net-metering Mode Task Test ( Export Energy Function )
11	SM-INTE-PLC-FU	Remote Firmware Upgrade Test-Unicast Update Meter
12	SM-INTE-PLC-DC	Schedule Data Collect test-DCU
13	SM-INTE-PLC-COM	G3 PLC Communication
14	SM-INTE-PLC-DATA	Data Correctness Test

Table 3-15 Test Group List

### 3.2.3.2 Test Setup

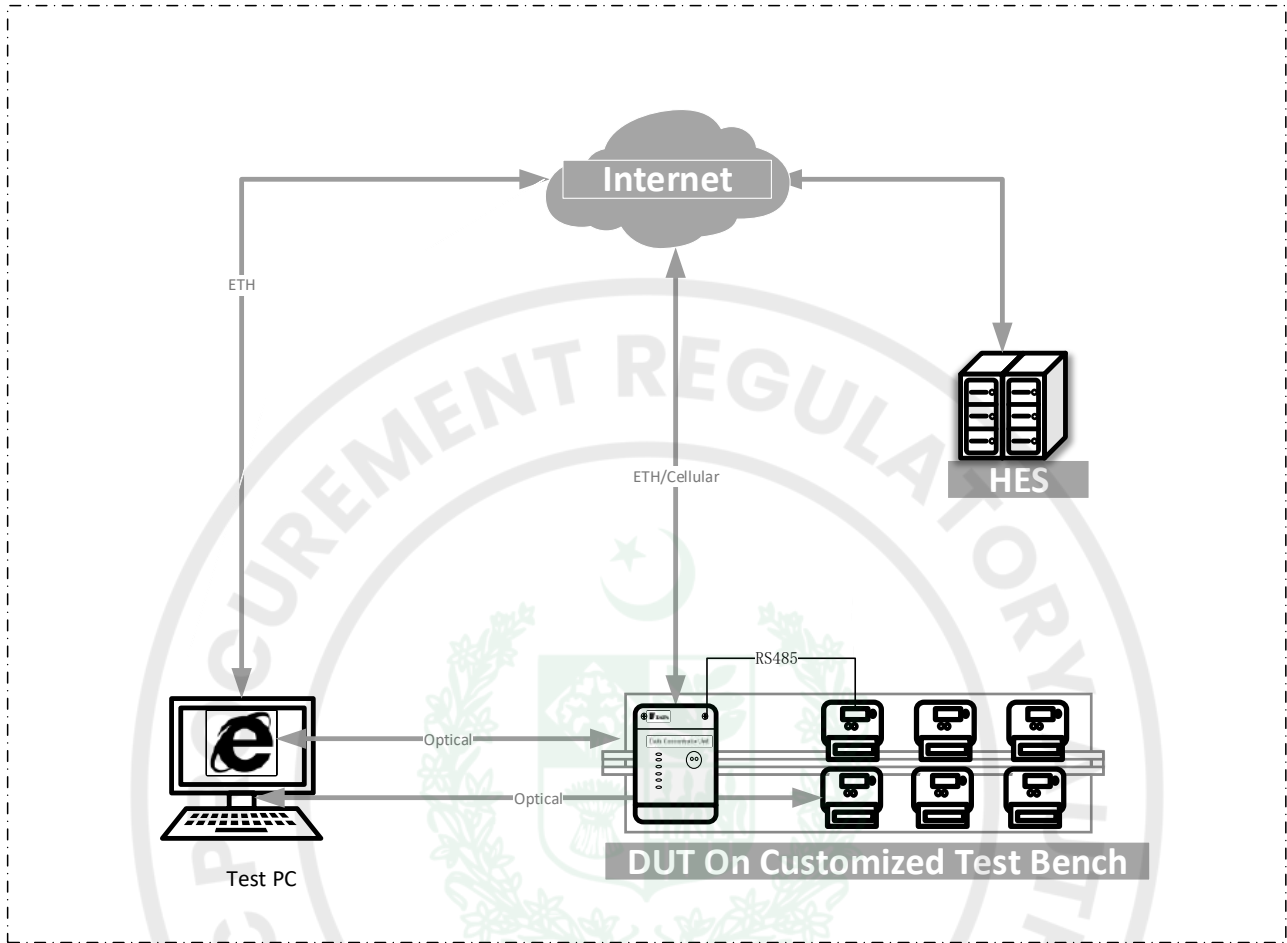

Figure 3-13 Test Setup for PLC Meter Integration Test

No.	Device	Qty.	Description
1	DUT	6	<ul style="list-style-type: none"> <li>2pcs meters are deployed in phase A.</li> <li>2pcs meters are deployed in phase B.</li> <li>2pcs meters are deployed in phase C.</li> </ul>
2	DCU	1	<ul style="list-style-type: none"> <li>Auxiliary test equipment, Simulate DCU operations to verify the correctness of the meter implementation</li> </ul>
3	Test PC	1	<ul style="list-style-type: none"> <li>Computer</li> <li>PC connect DUT meter via Optical port</li> <li>PC Connect DCU via Ethernet</li> </ul>
5	HES	1	<ul style="list-style-type: none"> <li>Head end system</li> </ul>
6	Customized Test Bench	1	<ul style="list-style-type: none"> <li>Including Customized test bench-control unit and Customized test bench-rack</li> <li>Power the test equipment and support the adjustment of voltage, current, and other parameters to create test conditions.</li> </ul>

Table 3-16 Device List for PLC Meter Integration Test

### 3.2.3.3 Test Group Device Registration

Test Group Information			
Test Group ID	SM-INTE-PLC-REG	Test Group Name	PLC Meter Registration
References	<ul style="list-style-type: none"> <li>[1] IESCO_AMI_Project, Technical Specification Smart Meter Companion Specification</li> <li>[4] IESCO_AMI_Project, dlms_obis_list</li> <li>[7] IESCO_AMI_Project, Technical Specification Head End System</li> </ul>		
Test Purpose	<ul style="list-style-type: none"> <li>Verify the device register to DCU &amp; HES</li> </ul>		
Test Setup and Condition	<ul style="list-style-type: none"> <li>Figure 3-13 Test Setup for PLC Meter Integration Test</li> </ul>		
Test Method	<ul style="list-style-type: none"> <li>Configure the DUT archive in HES</li> <li>Power on and check if the Meter register to the DCU and HES</li> </ul>		
Acceptance Criteria	<ul style="list-style-type: none"> <li>All the test case of this group is pass</li> </ul>		
Test Case Lists			
ID	Case Title		
SM-INTE-PLC-REG-001	Device Registration to DCU		
SM-INTE-PLC-REG -002	Device Registration to HES		

### 3.2.3.4 Test Group Data push Test-Meter Alarm/Event

Test Group Information			
Test Group ID	SM-INTE-PLC-PUSH	Test Group Name	Data push Test-Meter Alarm/Event
References	<ul style="list-style-type: none"> <li>[1] IESCO_AMI_Project, Technical Specification Smart Meter Companion Specification</li> <li>[4] IESCO_AMI_Project, dlms_obis_list</li> <li>[7] IESCO_AMI_Project, Technical Specification Head End System</li> </ul>		
Test Purpose	<ul style="list-style-type: none"> <li>Verify the DUT could push event/alarm correctly to DCU/HES.</li> </ul>		
Test Setup and Condition	<ul style="list-style-type: none"> <li>Figure 3-13 Test Setup for PLC Meter Integration Test</li> </ul>		
Test Method	<ul style="list-style-type: none"> <li>Trigger the DUT push event/alarm and check if it has been pushed to HES.</li> </ul>		
Acceptance Criteria	<ul style="list-style-type: none"> <li>All the test case of this group is pass</li> </ul>		
Test Case Lists			
ID	Case Title		
SM-INTE-PLC-PUSH-001	Data push Test-Meter Alarm/Event		

### 3.2.3.5 Test Group Remote Connect/Disconnect Test

Test Group Information			
Test Group ID	SM-INTE-PLC-RC	Test Group Name	Remote Connect/Disconnect Test
References	<ul style="list-style-type: none"> <li>[1] IESCO_AMI_Project, Technical Specification Smart Meter Companion Specification</li> <li>[4] IESCO_AMI_Project, dlms_obis_list</li> <li>[7] IESCO_AMI_Project, Technical Specification Head End System</li> </ul>		
Test Purpose	<ul style="list-style-type: none"> <li>Verify the remote relay connect/Disconnect meter works well</li> </ul>		

Title:	Interoperability Test Specification	Ver.	2.0	Page:	54 of 103
--------	-------------------------------------	------	-----	-------	-----------

Test Setup And Condition	<ul style="list-style-type: none"> <li>Figure 3-13 Test Setup for PLC Meter Integration Test</li> </ul>
Test Method	<ul style="list-style-type: none"> <li>Perform the remote connect/disconnect operation on the HES, and check if the meter action correctly.</li> </ul>
Acceptance Criteria	<ul style="list-style-type: none"> <li>All the test case of this group is pass</li> </ul>
Test Case Lists	
ID	Case Title
SM-INTE-PLC-RC -001	Remote connect Meter
SM-INTE-PLC-RC -002	Remote disconnect Meter

### 3.2.3.6 Test Group On Demand Operation Test

Test Group Information			
Test Group ID	SM-INTE-PLC-ODO	Test Group Name	On Demand Operation Test
References	<ul style="list-style-type: none"> <li>[1] IESCO_AMI_Project, Technical Specification Smart Meter Companion Specification</li> <li>[4] IESCO_AMI_Project, dlms_obis_list</li> <li>[7] IESCO_AMI_Project, Technical Specification Head End System</li> </ul>		
Test Purpose	<ul style="list-style-type: none"> <li>Verify the on-demand data request could be performed correctly</li> </ul>		
Test Setup and Condition	<ul style="list-style-type: none"> <li>Figure 3-13 Test Setup for PLC Meter Integration Test</li> </ul>		
Test Method	<ul style="list-style-type: none"> <li>Perform the on demand request and check the data..</li> </ul>		
Acceptance Criteria	<ul style="list-style-type: none"> <li>All the test case of this group is pass</li> </ul>		
Test Case Lists			
ID	Case Title		
SM-INTE-PLC-ODO	On Demand Data Request Test		

### 3.2.3.7 Test Group Configuration test

Test Group Information			
Test Group ID	SM-INTE-PLC-CFG	Test Group Name	Configuration test
References	<ul style="list-style-type: none"> <li>[1] IESCO_AMI_Project, Technical Specification Smart Meter Companion Specification</li> <li>[4] IESCO_AMI_Project, dlms_obis_list</li> <li>[7] IESCO_AMI_Project, Technical Specification Head End System</li> </ul>		
Test Purpose	<ul style="list-style-type: none"> <li>Verify the configure the meter's parameter</li> </ul>		
Test Setup and Condition	<ul style="list-style-type: none"> <li>Figure 3-13 Test Setup for PLC Meter Integration Test</li> </ul>		
Test Method	<ul style="list-style-type: none"> <li>Configure the meter's parameter from HES.</li> </ul>		
Acceptance Criteria	<ul style="list-style-type: none"> <li>All the test case of this group is pass</li> </ul>		
Test Case Lists			
ID	Case Title		
SM-INTE-PLC-CFG -001	Configuration test		

### 3.2.3.8 Test Group Tariff configure and active Test

Test Group Information			
Test Group ID	SM-INTE-PLC-TOU	Test Group Name	Tariff configure and active Test

Title:	Interoperability Test Specification	Ver.	2.0	Page:	55 of 103
--------	-------------------------------------	------	-----	-------	-----------

References	<ul style="list-style-type: none"> <li>[1] IESCO_AMI_Project, Technical Specification Smart Meter Companion Specification</li> <li>[4] IESCO_AMI_Project, dlms_obis_list</li> <li>[7] IESCO_AMI_Project, Technical Specification Head End System</li> </ul>
Test Purpose	<ul style="list-style-type: none"> <li>Verify the tariff configure and active with different manufactory DCU and HES</li> </ul>
Test Setup and Condition	<ul style="list-style-type: none"> <li>Figure 3-13 Test Setup for PLC Meter Integration Test</li> </ul>
Test Method	<ul style="list-style-type: none"> <li>Configure and active tariff from the HES</li> </ul>
Acceptance Criteria	<ul style="list-style-type: none"> <li>All the test case of this group is pass</li> </ul>
<b>Test Case Lists</b>	
ID	Case Title
SM-INTE-PLC-TOU-001	Tariff configure and active Test

### 3.2.3.9 Test Group Load Limitation Task Test

Test Group Information			
Test Group ID	SM-INTE-PLC-LL	Test Group Name	Load Limitation Task Test
References	<ul style="list-style-type: none"> <li>[1] IESCO_AMI_Project, Technical Specification Smart Meter Companion Specification</li> <li>[4] IESCO_AMI_Project, dlms_obis_list</li> <li>[7] IESCO_AMI_Project, Technical Specification Head End System</li> </ul>		
Test Purpose	<ul style="list-style-type: none"> <li>Verify the load limitation with different manufactory DCU and HES</li> </ul>		
Test Setup and Condition	<ul style="list-style-type: none"> <li>Figure 3-13 Test Setup for PLC Meter Integration Test</li> </ul>		
Test Method	<ul style="list-style-type: none"> <li>Configure and active the Load Limitation from the HES. Check if it is work.</li> </ul>		
Acceptance Criteria	<ul style="list-style-type: none"> <li>All the test case of this group is pass</li> </ul>		
<b>Test Case Lists</b>			
ID	Case Title		
SM-INTE-PLC-LL-001	Load Limitation Task Test		

### 3.2.3.10 Test Group Post Payment/Prepayment Task Test

Test Group Information			
Test Group ID	SM-INTE-PLC-PM	Test Group Name	Post Payment/Prepayment Task Test
References	<ul style="list-style-type: none"> <li>[1] IESCO_AMI_Project, Technical Specification Smart Meter Companion Specification</li> <li>[4] IESCO_AMI_Project, dlms_obis_list</li> <li>[7] IESCO_AMI_Project, Technical Specification Head End System</li> </ul>		
Test Purpose	<ul style="list-style-type: none"> <li>Verify the Post Payment/Prepayment Task integration with different manufactory DCU and HES</li> </ul>		
Test Setup and Condition	<ul style="list-style-type: none"> <li>Figure 3-13 Test Setup for PLC Meter Integration Test</li> </ul>		
Test Method	<ul style="list-style-type: none"> <li>Configure Post Payment/Prepayment Task from the HES. Check if it is work.</li> </ul>		
Acceptance Criteria	<ul style="list-style-type: none"> <li>All the test case of this group is pass</li> </ul>		
<b>Test Case Lists</b>			
ID	Case Title		
SM-INTE-PLC-PM-001	Post Payment/Prepayment Task Test		

Title:	Interoperability Test Specification	Ver.	2.0	Page:	56 of 103
--------	-------------------------------------	------	-----	-------	-----------

### 3.2.3.11 Test Group Low Credit Task Test

Test Group Information			
Test Group ID	SM-INTE-PLC-LC	Test Group Name	Low Credit Task Test
References	<ul style="list-style-type: none"> <li>[1] IESCO_AMI_Project, Technical Specification Smart Meter Companion Specification</li> <li>[4] IESCO_AMI_Project, dlms_obis_list</li> <li>[7] IESCO_AMI_Project, Technical Specification Head End System</li> </ul>		
Test Purpose	<ul style="list-style-type: none"> <li>Verify the Low Credit Task integration with different manufactory DCU and HES</li> </ul>		
Test Setup and Condition	<ul style="list-style-type: none"> <li>Figure 3-13 Test Setup for PLC Meter Integration Test</li> </ul>		
Test Method	<ul style="list-style-type: none"> <li>Configure Low Credit Task from the HES. Check if it is work.</li> </ul>		
Acceptance Criteria	<ul style="list-style-type: none"> <li>All the test case of this group is pass</li> </ul>		
Test Case Lists			
ID	Case Title		
SM-INTE-PLC-LC-001	Low Credit Task Test		

### 3.2.3.12 Test Group Net-metering Mode Task Test

Test Group Information			
Test Group ID	SM-INTE-PLC-NM	Test Group Name	Net-metering Mode Task Test
References	<ul style="list-style-type: none"> <li>[1] IESCO_AMI_Project, Technical Specification Smart Meter Companion Specification</li> <li>[4] IESCO_AMI_Project, dlms_obis_list</li> <li>[7] IESCO_AMI_Project, Technical Specification Head End System</li> </ul>		
Test Purpose	<ul style="list-style-type: none"> <li>Verify the integration Net-metering Mode Task with DUT and different manufactory DCU and HES</li> </ul>		
Test Setup And Condition	<ul style="list-style-type: none"> <li>Figure 3-13 Test Setup for PLC Meter Integration Test</li> </ul>		
Test Method	<ul style="list-style-type: none"> <li>Configure the Net-metering Mode Task from the HES. Check if it is work.</li> </ul>		
Acceptance Criteria	<ul style="list-style-type: none"> <li>All the test case of this group is pass</li> </ul>		
Test Case Lists			
ID	Case Title		
SM-INTE-PLC-NM-001	Net-metering Mode Task Test		

### 3.2.3.13 Test Group Remote Firmware Upgrade Test

Test Group Information			
Test Group ID	SM-INTE-PLC-FU	Test Group Name	Remote Firmware Upgrade Test
References	<ul style="list-style-type: none"> <li>[1] IESCO_AMI_Project, Technical Specification Smart Meter Companion Specification</li> <li>[4] IESCO_AMI_Project, dlms_obis_list</li> <li>[7] IESCO_AMI_Project, Technical Specification Head End System</li> </ul>		
Test Purpose	<ul style="list-style-type: none"> <li>Verify DUT Firmware upgrade test integration with different manufactory</li> </ul>		

Title:	Interoperability Test Specification	Ver.	2.0	Page:	57 of 103
--------	-------------------------------------	------	-----	-------	-----------

	DCU and HES
Test Setup and Condition	• Figure 3-13 Test Setup for PLC Meter Integration Test
Test Method	• Configure the Remote Firmware Upgrade Task from the HES. Check if it is work.
Acceptance Criteria	• All the test case of this group is pass
<b>Test Case Lists</b>	
ID	Case Title
SM-INTE-PLC-FU-001	Remote Firmware Upgrade Test-unicast upgrade meter
SM-INTE-PLC-FU-002	Remote Firmware Upgrade Test-unicast upgrade meter G3 PLC Module
SM-INTE-PLC-FU-003	Remote Firmware Upgrade Test-Broadcast upgrade meter
SM-INTE-PLC-FU-004	Remote Firmware Upgrade Test-Broadcast upgrade meter G3 PLC Module

### 3.2.3.14 Test Group Schedule Data Collect test

<b>Test Group Information</b>			
Test Group ID	SM-INTE-PLC-DC	Test Group Name	Schedule Data Collect test-DCU
References	<ul style="list-style-type: none"> <li>[1] IESCO_AMI_Project, Technical Specification Smart Meter Companion Specification</li> <li>[4] IESCO_AMI_Project, dlms_obis_list</li> <li>[7] IESCO_AMI_Project, Technical Specification Head End System</li> </ul>		
Test Purpose	• Verify the Up-Stream Schedule Data Collect test integration with different manufactory DCU and HES		
Test Setup and Condition	• Figure 3-13 Test Setup for PLC Meter Integration Test		
Test Method	• Configure t Schedule Data Collect Test Task from the HES/DCU. Check if it is work.		
Acceptance Criteria	• All the test case of this group is pass		
<b>Test Case Lists</b>			
ID	Case Title		
SM-INTE-PLC-DC-001	Schedule Data Collect test-DCU		
SM-INTE-PLC-DC-002	Schedule Data Collect test-HES		

### 3.2.3.15 Test Group G3 PLC Test

<b>Test Group Information</b>			
Test Group ID	TG-013	Test Group Name	G3 PLC Test
References	<ul style="list-style-type: none"> <li>[1] IESCO_AMI_Project, Technical Specification Smart Meter Companion Specification</li> <li>[4] IESCO_AMI_Project, dlms_obis_list</li> <li>[7] IESCO_AMI_Project, Technical Specification Head End System</li> </ul>		
Test Purpose	• Verify the G3 PLC integration with different manufactory DCU /HES		
Test Setup and Condition	• Figure 3-13 Test Setup for PLC Meter Integration Test		
Test Method	• Trigger the G3 PLC network behavior.		
Acceptance Criteria	• All the test case of this group is pass		
<b>Test Case Lists</b>			
ID	Case Title		

Title:	Interoperability Test Specification	Ver.	2.0	Page:	58 of 103
--------	-------------------------------------	------	-----	-------	-----------

TG-013-001	G3 PLC parameter configure and read
TG-013-002	Phase Detection
TG-013-003	RREQ/RREP
TG-013-004	PREQ/PREP
TG-013-005	Kick Off
TG-013-006	Repeater

### 3.2.3.16 Test Group Data Correctness Test

Test Group Information			
Test Group ID	SM-INTE-PLC-DATA	Test Group Name	Data Correctness Test
References	<ul style="list-style-type: none"> <li>[1] IESCO_AMI_Project, Technical Specification Smart Meter Companion Specification</li> <li>[4] IESCO_AMI_Project, dlms_obis_list</li> <li>[7] IESCO_AMI_Project, Technical Specification Head End System</li> </ul>		
Test Purpose	<ul style="list-style-type: none"> <li>Verify the Data Correctness</li> </ul>		
Test Setup and Condition	<ul style="list-style-type: none"> <li>The DUT function test is pass ;</li> <li>Figure 3-13 Test Setup for PLC Meter Integration Test</li> </ul>		
Test Method	<ul style="list-style-type: none"> <li>Check if data correctness by compare the meter's data both HES and meter.</li> </ul>		
Acceptance Criteria	<ul style="list-style-type: none"> <li>All the test case of this group is pass</li> </ul>		
Test Case Lists			
ID	Case Title		
SM-INTE-PLC-DATA-001	Data Correctness Test		

## 3.3 DCU with G3 PLC/Cellular Communication

For DCU with G3 PLC/Cellular Communication, the following tests must be conducted to ensure compatibility and seamless integration with other devices specified in the IESCO AMI Project.

- STEP1 Basic Function Compliance Test
  - DCU Functional Test
  - G3 PLC Performance Test
  - Cellular Performance Test
- STEP2 Integration Test-DCU to HES (CI1, CI2)
- STEP3 Real Environment Simulation Test

The DUT samples and reports/certificate should be provided

Item	Device	Qty.	Provider	Description
1	DUT Sample	6	Supplier	<ul style="list-style-type: none"> <li>1pcs for Function Test</li> <li>1pcs for G3 PLC/Cellular Performance Test</li> <li>1pcs for Integration Test</li> <li>1pcs for Real Enviroment SimulationTest</li> <li>2pcs backup</li> </ul>

2	DLMS Certification	1	Supplier	DLMS Protocol certificate (CTT4.3)
3	Firmware update file	1	Supplier	DUT firmware File for upgrade testing
4	DUT Test Report	1	Supplier	Type test report and software test report
5	Shipmen file	1	Supplier	Include secret keys of different clients
6	Tool	-	Supplier	Software testing tool offered by different manufacturers to support local/remote connection and operation with DCU
7	Cellular Network	-	IESCO	<ul style="list-style-type: none"> <li>• Support 2G and LTE</li> <li>• Support verify the APN (Access Point Name)</li> <li>• Support verify the PPP information</li> <li>• Support IPv4/v6</li> <li>• LTE Support Band3/Band8/Band20/Band28</li> <li>• 2G Support 900/1800 MHz</li> </ul>

**Table 3-17 DUT Requirements for DCU Test**

### 3.3.1 DCU Functional Test

The section is about the introduce of DCU functions test, including DCU DLMS Protocol conformance, security, basic information query, clock management, event, firmware upgrade, meter registration, meter data collection and data report functions and so on.

#### 3.3.1.1 Test Suite

The chapter is about the test suite which can be divided into twenty-one functional test groups as follows:

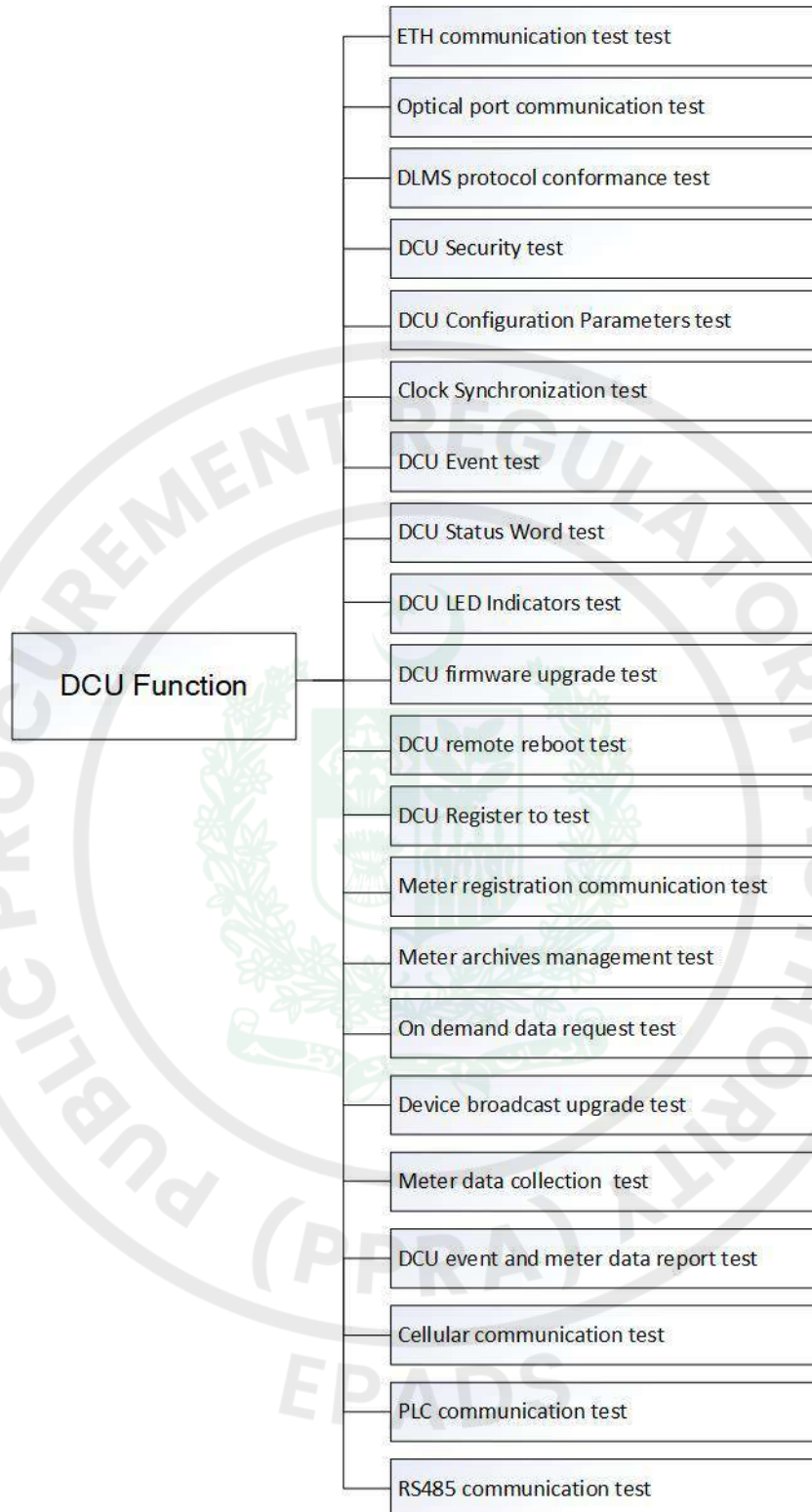

Figure 3-14 Test Groups

No.	Test Group ID	Test Group Name
1	DCU-FUNC-ETH	• ETH communication test
2	DCU-FUNC-OPT	• Optical Port communication test
3	DCU-FUNC-DLMS	• DLMS protocol conformance test

No.	Test Group ID	Test Group Name
4	DCU-FUNC-SE	• DCU Security test
5	DCU-FUNC-BASIC	• DCU Configuration Parameters test
6	DCU-FUNC-CLK	• Clock Synchronization test
7	DCU-FUNC-EVENT	• DCU Event test
8	DCU-FUNC-SW	• DCU Status Word test
9	DCU-FUNC-LED	• DCU LED Indicators test
10	DCU-FUNC-DUS	• DCU firmware upgrade test
11	DCU-FUNC-RBT	• DCU remote reboot test
12	DCU-FUNC-REG	• DCU Register test
13	DCU-FUNC-ME-REG	• Meter registration communication test
14	DCU-FUNC-ME-ARCH	• Meter archives management test
15	DCU-FUNC-ME-OD	• On demand data request test
16	DCU-FUNC-ME-DUS	• Device broadcast upgrade test
17	DCU-FUNC-ME-DC	• Meter data collection test
18	DCU-FUNC-DR	• DCU event and meter data report test
19	DCU-FUNC-CELL	• Cellular communication test
20	DCU-FUNC-PLC	• PLC communication test
21	DCU-FUNC-485	• RS485 communication test

Table 3-18 Test Group List for DCU Function Test

### 3.3.1.2 Test Setup

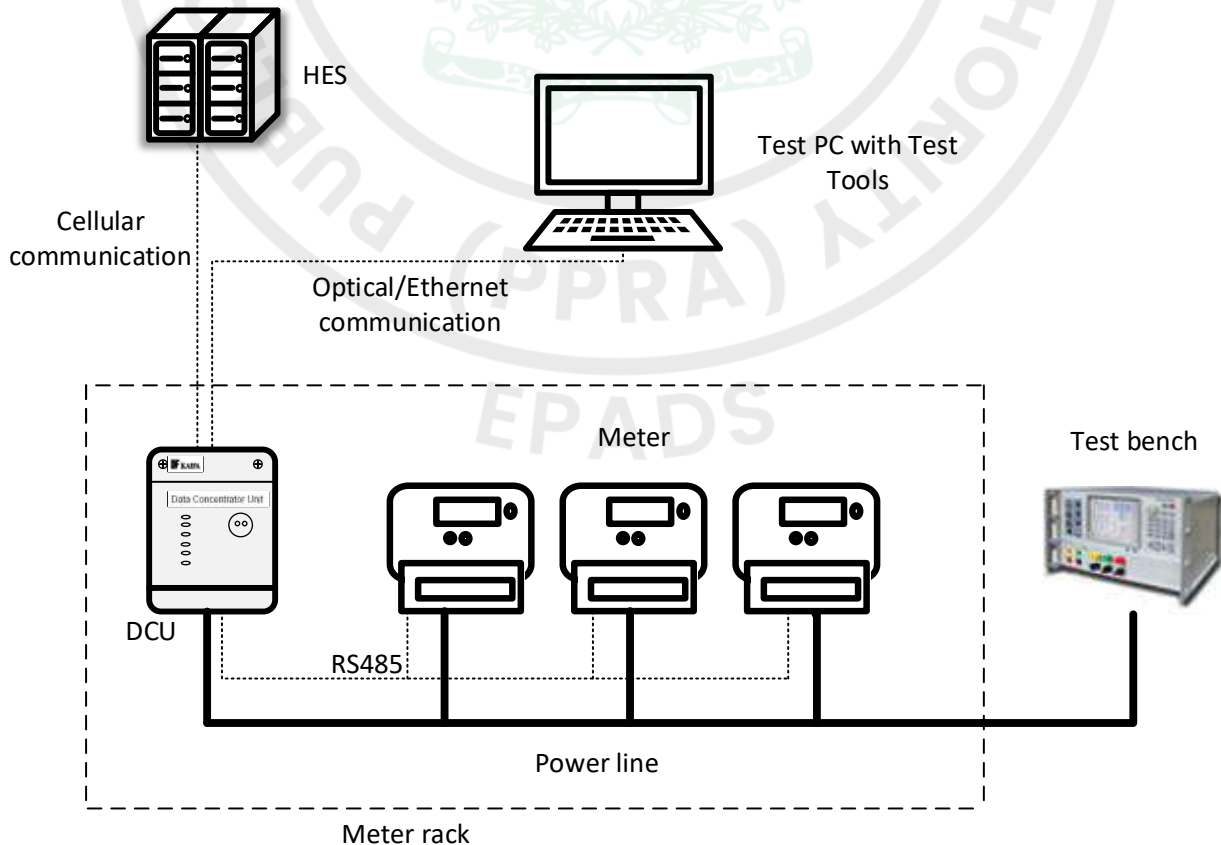

**Figure 3-15 Test Setup for DCU Function Test**

No.	Device	Qty.	Description
1	DCU	1	DUT
2	Meter	3	Auxiliary test equipment, the meters play a role in providing different meter data for DCU to collect or push the data via DCU when they receive commands from the HES.
3	LIS Test Tool	1	Auto test software, used to schedule automated test execution
4	Test PC	1	<ul style="list-style-type: none"> <li>• Computer</li> <li>• PC connect meter via Optical port</li> <li>• PC Connect DCU via Ethernet</li> </ul>
5	Power Supply	1	Isolation Step-up/down Transformer The machine is used to supply power for devices
6	Cellular Network	-	<ul style="list-style-type: none"> <li>• IESCO provided</li> <li>• Support GPRS and LTE</li> <li>• Support verify the APN (Access Point Name)</li> <li>• Support verify the PPP information</li> <li>• Support IPv4/v6</li> </ul>

**Table 3-19 Test Setup for DCU Function Test**

### 3.3.1.3 Test Group ETH Communication test

Test Group Information			
Test Group ID	DCU-FUNC-ETH	Test Group Name	ETH Communication test
References	<ul style="list-style-type: none"> <li>• [12] IESCO_AMI_Project, Technical Specification DCU Companion Specification, V1.4, 2024. Section 2.1.2 WAN – HES Interface (CI2)</li> <li>• [2] DLMS User Association, DLMS UA 1000-1 Ed.14, 2020.</li> <li>• [3] DLMS User Association, DLMS UA 1000-2 Ed.10, 2020.</li> </ul>		
Test Purpose	<ul style="list-style-type: none"> <li>• To satisfy the [12] document’s requirements and follow [2] [3]</li> </ul>		
Test Setup and Condition	<ul style="list-style-type: none"> <li>• Figure 3-15 Test Setup for DCU Function Test</li> <li>• Figure 3-15 Test Setup for DCU Function Test</li> </ul>		
Test Method	<ul style="list-style-type: none"> <li>• Use automatic method to execute the cases.</li> <li>• Check the correctness of ETH communication interface.</li> </ul>		
Acceptance Criteria	<ul style="list-style-type: none"> <li>• All the test cases of this group execution and pass rates are 100%</li> </ul>		
Test Case Lists			
ID	Case Title		Test Type
DCU-FUNC-ETH-001	Check ETH related DLMS Parameters		Auto
DCU-FUNC-ETH-002	The Ipv4 communication is normal when using ETH to connect to DCU		Auto
DCU-FUNC-ETH-003	The Ipv6 communication is normal when using ETH to connect to DCU		Manual

### 3.3.1.4 Test Group Optical Port Communication test

Test Group Information		
Test Group ID	DCU-FUNC-OPT	Test Group Name Optical Port Communication test
References	<ul style="list-style-type: none"> <li>[12] IESCO_AMI_Project, Technical Specification DCU Companion Specification, V1.4, 2024. Section 2.1.1 Optical Interface (CIO)</li> <li>[2] DLMS User Association, DLMS UA 1000-1 Ed.14, 2020.</li> <li>[3] DLMS User Association, DLMS UA 1000-2 Ed.10, 2020.</li> </ul>	
Test Purpose	<ul style="list-style-type: none"> <li>To satisfy the DCU Companion Specification document's requirements and follow DLMS protocol</li> </ul>	
Test Setup and Condition	<ul style="list-style-type: none"> <li>Figure 3-15 Test Setup for DCU Function Test</li> </ul>	
Test Method	<ul style="list-style-type: none"> <li>Use automatic method to execute the cases.</li> <li>Check the correctness of Optical communication interface.</li> </ul>	
Acceptance Criteria	<ul style="list-style-type: none"> <li>All the test cases of this group execution and pass rates are 100%</li> </ul>	
Test Case Lists		
ID	Case Title	Test Type
DCU-FUNC-OPT-001	Check Optical port related DLMS Parameters	Auto
DCU-FUNC-OPT-002	Use Optical port to connect to DCU	Auto

### 3.3.1.5 Test Group DLMS Protocol conformance test

Test Group Information		
Test Group ID	DCU-FUNC-DLMS	Test Group Name DLMS protocol conformance test
References	<ul style="list-style-type: none"> <li>[12] IESCO_AMI_Project, Technical Specification DCU Companion Specification, V1.4, 2024. Section 2 System and Interface Architecture</li> <li>[2] DLMS User Association, DLMS UA 1000-1 Ed.14, 2020.</li> <li>[3] DLMS User Association, DLMS UA 1000-2 Ed.10, 2020.</li> </ul>	
Test Purpose	<ul style="list-style-type: none"> <li>To verify compliance of the [2] [3] [12]</li> </ul>	
Test Setup and Condition	<ul style="list-style-type: none"> <li>Figure 3-15 Test Setup for DCU Function Test</li> </ul>	
Test Method	<ul style="list-style-type: none"> <li>Use automatic method to execute the cases.</li> <li>Use the service of each client to test the operation of the objects.</li> <li>Write automatic scripts to execute the method of each COSEM object.</li> <li>Write automatic scripts to verify establish application association and release process with DCU, etc.</li> </ul>	
Acceptance Criteria	<ul style="list-style-type: none"> <li>All the test cases of this group execution and pass rates are 100%</li> </ul>	
Test Case Lists		
ID	Case Title	Test Type
DCU-FUNC-DLMS-001	Check the access rights of all clients in SM	Auto
DCU-FUNC-DLMS-002	Check communication process of all clients complying DLMS protocol	Auto
DCU-FUNC-DLMS-003	Check data transfer service of SM	Auto
DCU-FUNC-DLMS-004	Check data framed complying corresponding communication profiles	Auto

Title:	Interoperability Test Specification	Ver.	2.0	Page:	64 of 103
--------	-------------------------------------	------	-----	-------	-----------

DCU-FUNC-DLMS-004	Invalid value of each data frame field test	Auto
-------------------	---	------

### 3.3.1.6 Test Group DCU Security test

Test Group Information		
Test Group ID	DCU-FUNC-SE	Test Group Name DCU Security test
References	<ul style="list-style-type: none"> <li>[12] IESCO_AMI_Project, Technical Specification DCU Companion Specification, V1.4, 2024. Section 3.2 Security Features</li> <li>[2] DLMS User Association, DLMS UA 1000-1 Ed.14, 2020.</li> <li>[3] DLMS User Association, DLMS UA 1000-2 Ed.10, 2020.</li> </ul>	
Test Purpose	<ul style="list-style-type: none"> <li>To satisfy the [12] document's requirements and follow [2] [3]</li> </ul>	
Test Setup and Condition	<ul style="list-style-type: none"> <li>Figure 3-15 Test Setup for DCU Function Test</li> </ul>	
Test Method	<ul style="list-style-type: none"> <li>Use automatic method to execute the cases.</li> <li>Select different clients to connect to DCU.</li> <li>Modify the secret keys of communication via the 'key transfer' method, and using the new one to connect to DCU, or use the wrong key to connect to DCU.</li> <li>Connect to DCU with wrong format of frames.</li> </ul>	
Acceptance Criteria	<ul style="list-style-type: none"> <li>All the test cases of this group execution and pass rates are 100%</li> </ul>	
Test Case Lists		
ID	Case Title	Test Type
DCU-FUNC-SE-001	Check the default parameters of Security Management	Auto
DCU-FUNC-SE-002	Management client connects to DCU	Auto
DCU-FUNC-SE-003	Read client connects to DCU	Auto
DCU-FUNC-SE-004	Public client connects to DCU	Auto
DCU-FUNC-SE-005	A wrong Authentication key connects to DCU	Auto
DCU-FUNC-SE-006	A wrong Encryption key connects to DCU	Auto
DCU-FUNC-SE-007	Key change test of Authentication key	Auto
DCU-FUNC-SE-008	Key change test of Encryption key	Auto
DCU-FUNC-SE-009	Wrong format of frames connects to DCU	Auto

### 3.3.1.7 Test Group DCU Configuration Parameters test

Test Group Information		
Test Group ID	DCU-FUNC-BASIC	Test Group Name DCU Configuration Parameters test
References	<ul style="list-style-type: none"> <li>[12] IESCO_AMI_Project, Technical Specification DCU Companion Specification, V1.4, 2024. Section 5.1 DCU Configure Parameters</li> </ul>	
Test Purpose	<ul style="list-style-type: none"> <li>To satisfy the [12] document's requirements and verify DCU basic information query function</li> </ul>	
Test Setup and Condition	<ul style="list-style-type: none"> <li>Figure 3-15 Test Setup for DCU Function Test</li> </ul>	
Test Method	<ul style="list-style-type: none"> <li>Use automatic method to execute the cases.</li> <li>Verify the correctness of different configuration parameters' interfaces.</li> <li>Connect to DCU by remote/local communication, and execute DCU basic information query.</li> </ul>	
Acceptance Criteria	<ul style="list-style-type: none"> <li>All the test cases of this group execution and pass rates are 100%</li> </ul>	
Test Case Lists		

Title:	Interoperability Test Specification	Ver.	2.0	Page:	65 of 103
--------	-------------------------------------	------	-----	-------	-----------

ID	Case Title	Test Type
DCU-FUNC-BASIC-001	Check DCU Identification information	Auto
DCU-FUNC-BASIC-002	Check DCU version information	Auto
DCU-FUNC-BASIC-003	Check PLC Communication mode version information	Auto
DCU-FUNC-BASIC-004	Check Cellular Communication mode version information	Auto
DCU-FUNC-BASIC-005	Check and set HES communication parameter configuration	Auto

### 3.3.1.8 Test Group Clock Synchronization test

Test Group Information			
Test Group ID	DCU-FUNC-CLK	Test Group Name	Clock Synchronization test
References	<ul style="list-style-type: none"> <li>[12] IESCO_AMI_Project, Technical Specification DCU Companion Specification, V1.4, 2024. Section 5.8 Clock Synchronization</li> </ul>		
Test Purpose	<ul style="list-style-type: none"> <li>To satisfy the [12] document's requirements and verify DCU clock synchronization function</li> </ul>		
Test Setup and Condition	<ul style="list-style-type: none"> <li>Figure 3-15 Test Setup for DCU Function Test</li> </ul>		
Test Method	<ul style="list-style-type: none"> <li>Use automatic method to execute the cases.</li> <li>Verify the correctness of clock management configuration parameters' interfaces.</li> <li>Connect to DCU by remote/local communication, and verify the function of DCU clock synchronization automatically or by executing scripts.</li> <li>Verify that the clock runs well when the power supply is off.</li> </ul>		
Acceptance Criteria	<ul style="list-style-type: none"> <li>All the test cases of this group execution and pass rates are 100%</li> </ul>		
Test Case Lists			
ID	Case Title		Test Type
DCU-FUNC-CLK-001	Check the default value of time zone		Auto
DCU-FUNC-CLK-002	Check and set clock by the interface of class 8		Auto
DCU-FUNC-CLK-003	Check and set NTP Setup - Master parameters by the interface of class 100		Auto
DCU-FUNC-CLK-004	Check and set NTP Setup - Slave parameters by the interface of class 100		Auto
DCU-FUNC-CLK-005	Check the NTP Synchronization Script by the interface of class 9		Auto
DCU-FUNC-CLK-006	Check the Broadcast Clock Synchronization Script by the interface of class 9		Auto
DCU-FUNC-CLK-007	Check the DCU Schedule Setup by the interface of class 10		Auto
DCU-FUNC-CLK-008	The DCU automatically synchronizes its own clock with the NTP server every day		Auto
DCU-FUNC-CLK-009	Synchronize the DCU's clock with the NTP server by executing the script of class 9		Auto
DCU-FUNC-CLK-010	The DCU automatically synchronizes the clock of the meters once a day		Auto
DCU-FUNC-CLK-011	The DCU broadcast synchronizes the meters' clock by executing the script of class 9		Auto
DCU-FUNC-CLK-012	Check that the clock runs well when the power supply is off		Auto

### 3.3.1.9 Test Group DCU Event test

Test Group Information		
Test Group ID	DCU-FUNC-EVENT	Test Group Name DCU Event test
References	<ul style="list-style-type: none"> <li>[12] IESCO_AMI_Project, Technical Specification DCU Companion Specification, V1.4, 2024. Section 5.6 Event Management</li> </ul>	
Test Purpose	<ul style="list-style-type: none"> <li>To satisfy the [12] document's requirements and verify DCU event record function is normal</li> </ul>	
Test Setup and Condition	<ul style="list-style-type: none"> <li>Figure 3-15 Test Setup for DCU Function Test</li> </ul>	
Test Method	<ul style="list-style-type: none"> <li>Use semi-automatic method to execute the cases.</li> <li>Verify different types of events by the time.</li> <li>Verify that read the events by the entries normally.</li> <li>Verify the maximum storing entries of every kind of event.</li> <li>Connect to DCU by remote/local communication and generate all kinds of events like powering off/on the DCU, or opening/closing the covers of the DCU and so on. Finally, check if the events are recorded and if the recorded time is right.</li> </ul>	
Acceptance Criteria	<ul style="list-style-type: none"> <li>All the test cases of this group execution and pass rates are 100%</li> </ul>	
Test Case Lists		
ID	Case Title	Test Type
DCU-FUNC-EVENT-001	Check the different types of events by the time	Auto/Manual
DCU-FUNC-EVENT-002	Check the different events by the entries	Auto/Manual
DCU-FUNC-EVENT-003	Check the maximum storing entries of every kind of event	Auto/Manual
DCU-FUNC-EVENT-004 ~ DCU-FUNC-EVENT-022	Standard event - Event refer to [12] Section 5.6 Event Management	Auto/Manual
DCU-FUNC-EVENT-023 ~ DCU-FUNC-EVENT-026	Fraud event - Event refer to [12] Section 5.6 Event Management	Auto/Manual
DCU-FUNC-EVENT-027 ~ DCU-FUNC-EVENT-030	Access event - Event refer to [12] Section 5.6 Event Management	Auto/Manual
DCU-FUNC-EVENT-031 ~ DCU-FUNC-EVENT-034	High Occurrence event - Event refer to [12] Section 5.6 Event Management	Auto/Manual
DCU-FUNC-EVENT-	Registered event - Event refer to [12] Section 5.6 Event	Auto/Manual

Title:	Interoperability Test Specification	Ver.	2.0	Page:	67 of 103
--------	-------------------------------------	------	-----	-------	-----------

035	Management	
DCU-FUNC-EVENT-036	Meter Related event - Event refer to [12] Section 5.6 Event Management	Auto/Manual
DCU-FUNC-EVENT-037	Firmware event - Event refer to [12] Section 5.6 Event Management	Auto/Manual
~		
DCU-FUNC-EVENT-040		

### 3.3.1.10 Test Group DCU Status Word test

Test Group Information			
Test Group ID	DCU-FUNC-SW	Test Group Name	DCU Status Word test
References	<ul style="list-style-type: none"> <li>[12] IESCO_AMI_Project, Technical Specification DCU Companion Specification, V1.4, 2024. Section 5.7 Status Word</li> </ul>		
Test Purpose	<ul style="list-style-type: none"> <li>To satisfy the [12] document's requirements and verify DCU status word function is normal</li> </ul>		
Test Setup and Condition	<ul style="list-style-type: none"> <li>Figure 3-15 Test Setup for DCU Function Test</li> </ul>		
Test Method	<ul style="list-style-type: none"> <li>Use semi-automatic method to execute the cases. (like open/close covers and plug-in/out the modules, etc.)</li> <li>Connect to DCU by remote/local communication, and generate the events which will trigger the related DCU status word bit to be up. After that, recover the anomalies and check if the related DCU status word bit will be down.</li> </ul>		
Acceptance Criteria	<ul style="list-style-type: none"> <li>All the test cases of this group execution and pass rates are 100%</li> </ul>		
Test Case Lists			
ID	Case Title		Test Type
DCU-FUNC-SW-001	The "Device power up" status word records		Auto
DCU-FUNC-SW-002	The "Cellular Communication module failure" status word records		Manual
DCU-FUNC-SW-003	The "Cellular Communication signal level is too low" status word records		Manual
DCU-FUNC-SW-004	The "PLC module failure" status word records		Manual
DCU-FUNC-SW-005	The "Flash space full alarm" status word records		Manual
DCU-FUNC-SW-006	The "Main cover removal" status word records		Manual
DCU-FUNC-SW-007	The "DCU unlock" status word records		Auto
DCU-FUNC-SW-008	The "Optical port failure" status word records		Manual
DCU-FUNC-SW-009	The "RS-485 failure" status word records		Manual
DCU-FUNC-SW-010	The "Clock invalid" status word records		Auto
DCU-FUNC-SW-011	The "Stand-alone mode" status word records		Auto
DCU-FUNC-SW-012	The "Image downloading" status word records		Manual
DCU-FUNC-SW-013	The "Phase failure" status word records		Auto

### 3.3.1.11 Test Group DCU LED Indicators test

Test Group Information			
Test Group ID	DCU-FUNC-LED	Test Group Name	DCU LED Indicators test
References	<ul style="list-style-type: none"> <li>[13] IESCO_AMI_Project, Technical Specification Data Concentrator Unit</li> </ul>		

Title:	Interoperability Test Specification	Ver.	2.0	Page:	68 of 103
--------	-------------------------------------	------	-----	-------	-----------

Specification Section 5.4.1 DCU LED indicators		
Test Purpose	<ul style="list-style-type: none"> <li>To satisfy the [13] document's requirements</li> </ul>	
Test Setup and Condition	<ul style="list-style-type: none"> <li>Figure 3-15 Test Setup for DCU Function Test</li> </ul>	
Test Method	<ul style="list-style-type: none"> <li>Use manual method to execute the cases.</li> <li>Check the display correctness of every single LED indicator.</li> </ul>	
Acceptance Criteria	<ul style="list-style-type: none"> <li>All the test cases of this group execution and pass rates are 100%</li> </ul>	
Test Case Lists		
ID	Case Title	Test Type
DCU-FUNC-LED-001	Check the display of Power indicator	Manual
DCU-FUNC-LED-002	Check the display of Phase L1 indicator	Manual
DCU-FUNC-LED-003	Check the display of Phase L2 indicator	Manual
DCU-FUNC-LED-004	Check the display of Phase L3 indicator	Manual
DCU-FUNC-LED-005	Check the display of Alarm indicator	Manual
DCU-FUNC-LED-006	Check the display of WAN indicator	Manual
DCU-FUNC-LED-007	Check the display of LAN PLC indicator	Manual
DCU-FUNC-LED-008	Check the display of LAN RS485 indicator	Manual

### 3.3.1.12 Test Group DCU firmware upgrade test

Test Group Information			
Test Group ID	DCU-FUNC-DUS	Test Group Name	DCU firmware upgrade test
References	<ul style="list-style-type: none"> <li>[12] IESCO_AMI_Project, Technical Specification DCU Companion Specification, V1.4, 2024. Section 5.9.1 DCU Firmware Upgrade</li> </ul>		
Test Purpose	<ul style="list-style-type: none"> <li>To satisfy the [12] document's requirements and verify DCU firmware upgrade function is normal</li> </ul>		
Test Setup and Condition	<ul style="list-style-type: none"> <li>Figure 3-15 Test Setup for DCU Function Test</li> </ul>		
Test Method	<ul style="list-style-type: none"> <li>Use automatic method to execute the cases.</li> <li>Check if the default value of upgrade enable interface is normal.</li> <li>Verify the correctness of upgrade interface.</li> <li>Connect to DCU by remote/local communication and execute the upgrading tasks of DCU; after upgrading, check if the software version is updated.</li> </ul>		
Acceptance Criteria	<ul style="list-style-type: none"> <li>All the test cases of this group execution and pass rates are 100%</li> </ul>		
Test Case Lists			
ID	Case Title		Test Type
DCU-FUNC-DUS-001	Check the default value of upgrade enable		Auto
DCU-FUNC-DUS-002	Check upgrade related DLMS Parameters		Auto
DCU-FUNC-DUS-003	Upgrade the DCU by DLMS class id=18		Auto
DCU-FUNC-DUS-004	Upgrade the PLC module of DCU by DLMS class id=18		Auto

### 3.3.1.13 Test Group DCU remote reboot test

Test Group Information			
Test Group ID	DCU-FUNC-RBT	Test Group Name	DCU remote reboot test
References	<ul style="list-style-type: none"> <li>[12] IESCO_AMI_Project, Technical Specification DCU Companion</li> </ul>		

Title:	Interoperability Test Specification	Ver.	2.0	Page:	69 of 103
--------	-------------------------------------	------	-----	-------	-----------

	Specification, V1.4, 2024. Section 5.11 Remote Reboot	
Test Purpose	<ul style="list-style-type: none"> <li>To satisfy the [12] document's requirements and verify DCU remote reboot function is normal</li> </ul>	
Test Setup and Condition	<ul style="list-style-type: none"> <li>Figure 3-15 Test Setup for DCU Function Test</li> </ul>	
Test Method	<ul style="list-style-type: none"> <li>Using automatic method to execute the cases.</li> <li>Connect to DCU by local/remote communication and execute the remote reboot commands to DCU. After the DCU reboot, check if all the applications boot well.</li> </ul>	
Acceptance Criteria	<ul style="list-style-type: none"> <li>All the test cases of this group execution and pass rates are 100%</li> </ul>	
<b>Test Case Lists</b>		
ID	Case Title	Test Type
DCU-FUNC-RBT-001	Remote reboot DCU by DLMS class id=9	Auto

### 3.3.1.14 Test Group DCU Register test

<b>Test Group Information</b>			
Test Group ID	DCU-FUNC-REG	Test Group Name	DCU Register test
References	<ul style="list-style-type: none"> <li>[12] IESCO_AMI_Project, Technical Specification DCU Companion Specification, V1.4, 2024. Section 5.12.1 Push setup – On Connectivity</li> </ul>		
Test Purpose	<ul style="list-style-type: none"> <li>To satisfy the [12] document's requirements and verify DCU register function is normal</li> </ul>		
Test Setup and Condition	<ul style="list-style-type: none"> <li>Figure 3-15 Test Setup for DCU Function Test</li> </ul>		
Test Method	<ul style="list-style-type: none"> <li>Using automatic method to test the cases.</li> <li>Check if the correctness of push objects list's content</li> <li>Connect to DCU by local/remote communication and choose different communication channels to check if the registration messages that the DCU reports.</li> </ul>		
Acceptance Criteria	<ul style="list-style-type: none"> <li>All the test cases of this group execution and pass rates are 100%</li> </ul>		
<b>Test Case Lists</b>			
ID	Case Title	Test Type	
DCU-FUNC-REG-001	Check the correctness of push objects list's content	Auto	
DCU-FUNC-REG-002	Check the registration message of Cellular communication	Auto	
DCU-FUNC-REG-003	Check the registration message of ETH communication	Auto	

### 3.3.1.15 Test Group Meter registration communication test

<b>Test Group Information</b>			
Test Group ID	DCU-FUNC-ME-REG	Test Group Name	Meter registration communication test
References	<ul style="list-style-type: none"> <li>[12] IESCO_AMI_Project, Technical Specification DCU Companion Specification, V1.4, 2024. Section 5.3 Meter Registration and Deregistration Procedure</li> </ul>		
Test Purpose	<ul style="list-style-type: none"> <li>To satisfy the [12] document's requirements and verify meter registration communication function is normal</li> </ul>		
Test Setup and Condition	<ul style="list-style-type: none"> <li>Figure 3-15 Test Setup for DCU Function Test</li> </ul>		
Test Method	<ul style="list-style-type: none"> <li>Use automatic method to test the cases.</li> </ul>		

	<ul style="list-style-type: none"> <li>Check the correctness of meter registration management interface</li> <li>Connect to DCU by local/remote communication and choose meters with different communication types to register to DCU.</li> <li>Use registered meters with archives to connect to DCU.</li> </ul>	
Acceptance Criteria	<ul style="list-style-type: none"> <li>All the test cases of this group execution and pass rates are 100%</li> </ul>	
Test Case Lists		
ID	Case Title	Test Type
DCU-FUNC-ME-REG-001	Check the correctness of Registration Procedure interface	Auto
DCU-FUNC-ME-REG-002	Check the correctness of Meter Deregistration Procedure interface	Auto
DCU-FUNC-ME-REG-003	Check the correctness of Meter Black White List interface	Auto
DCU-FUNC-ME-REG-004	PLC meters without archives register to DCU for the first time	Auto
DCU-FUNC-ME-REG-005	Registered PLC meters with archives register to DCU again	Auto
DCU-FUNC-ME-REG-006	RS485 meters without archives register to DCU for the first time	Auto
DCU-FUNC-ME-REG-007	Check that the communication recovers normally when the power supply is on again	Auto

### 3.3.1.16 Test Group Meter Archives management test

Test Group Information			
Test Group ID	DCU-FUNC-ME-ARCH	Test Group Name	Meter archives management test
References	<ul style="list-style-type: none"> <li>[12] IESCO_AMI_Project, Technical Specification DCU Companion Specification, V1.4, 2024. Section 5.2 Meter Archive Table</li> </ul>		
Test Purpose	<ul style="list-style-type: none"> <li>To satisfy the [12] document's requirements and verify DCU's meter archives management function is normal</li> </ul>		
Test Setup and Condition	<ul style="list-style-type: none"> <li>Figure 3-15 Test Setup for DCU Function Test</li> </ul>		
Test Method	<ul style="list-style-type: none"> <li>Use automatic method to test the cases.</li> <li>Check the correctness of meter archives management interface</li> <li>Connect to DCU by local/remote communication. After the meters have registered to DCU, the HES automatically sends down the meters' archives to DCU or the tester manually adds archives to DCU.</li> <li>Modify the meters' archives in DCU, and check if it works.</li> <li>Delete the archives of meters from DCU, and the DCU will collect and transmit the meters' data unsuccessfully.</li> </ul>		
Acceptance Criteria	<ul style="list-style-type: none"> <li>All the test cases of this group execution and pass rates are 100%</li> </ul>		
Test Case Lists			
ID	Case Title	Test Type	
DCU-FUNC-ME-ARCH-001	Check the correctness of meter archives management interface	Auto	
DCU-FUNC-ME-ARCH-002	Add the archives of Single phase meter (PLC) to DCU	Auto	

Title:	Interoperability Test Specification	Ver.	2.0	Page:	71 of 103
--------	-------------------------------------	------	-----	-------	-----------

DCU-FUNC-ME-ARCH-003	Add the archives of Poly phase meter (PLC) to DCU	Auto
DCU-FUNC-ME-ARCH-004	Add the archives of Current transformer meter (RS485) to DCU	Auto
DCU-FUNC-ME-ARCH-005	Modify the meters' archives in DCU	Auto
DCU-FUNC-ME-ARCH-006	Delete the meters' archives in DCU	Auto

### 3.3.1.17 Test Group On demand data request test

Test Group Information		
Test Group ID	DCU-FUNC-OD	Test Group Name   On demand data request test
References	<ul style="list-style-type: none"> <li>[12] IESCO_AMI_Project, Technical Specification DCU Companion Specification, V1.4, 2024. Section 5.4 On-demand Command</li> </ul>	
Test Purpose	<ul style="list-style-type: none"> <li>To satisfy the [12] document's requirements and verify DCU supports on demand requests and responses transferring function</li> </ul>	
Test Setup and Condition	<ul style="list-style-type: none"> <li>Figure 3-15 Test Setup for DCU Function Test</li> </ul>	
Test Method	<ul style="list-style-type: none"> <li>Use automatic method to test the cases.</li> <li>Connect to the meters via DCU and read and set the meters' data.</li> </ul>	
Acceptance Criteria	<ul style="list-style-type: none"> <li>All the test cases of this group execution and pass rates are 100%</li> </ul>	
Test Case Lists		
ID	Case Title	Test Type
DCU-FUNC-OD-001	Read the PLC meters' data like clock, version, logical name via DCU	Auto
DCU-FUNC-OD-002	Read the RS485 meters' data like clock, version, logical name via DCU	Auto
DCU-FUNC-OD-003	Set the PLC meters' data like clock via DCU	Auto
DCU-FUNC-OD-004	Set the RS485 meters' data like clock via DCU	Auto
DCU-FUNC-OD-005	Upgrade the PLC meters via DCU	Auto
DCU-FUNC-OD-006	Upgrade the RS485 meters via DCU	Auto

### 3.3.1.18 Test Group Device broadcast upgrade test

Test Group Information		
Test Group ID	DCU-FUNC-ME-DUS	Test Group Name   Device broadcast upgrade test
References	<ul style="list-style-type: none"> <li>[12] IESCO_AMI_Project, Technical Specification DCU Companion Specification, V1.4, 2024. Section 5.9.2 Meter Firmware upgrade</li> </ul>	
Test Purpose	<ul style="list-style-type: none"> <li>To satisfy the [12] document's requirements and verify DCU broadcast upgrade meters function is normal</li> </ul>	
Test Setup and Condition	<ul style="list-style-type: none"> <li>Figure 3-15 Test Setup for DCU Function Test</li> </ul>	
Test Method	<ul style="list-style-type: none"> <li>Use automatic the method to test cases.</li> <li>Check the correctness of broadcast upgrade task interface.</li> <li>Connect to DCU by local/remote communication and execute broadcast upgrading tasks to different types of meters.</li> <li>Set the different beginning time to execute upgrading tasks, such as the past</li> </ul>	

	time to execute the tasks immediately or the future time to execute the tasks at the specific time.	
	<ul style="list-style-type: none"> <li>After upgrading, using the software testing tool to check if the software versions of the meters or PLC modules are upgraded.</li> </ul>	
Acceptance Criteria	<ul style="list-style-type: none"> <li>All the test cases of this group execution and pass rates are 100%</li> </ul>	
Test Case Lists		
ID	Case Title	Test Type
DCU-FUNC-METER-DUS-001	Check the correctness of broadcast upgrade task interface	Auto
DCU-FUNC-METER-DUS-002	The DCU broadcast upgrades the PLC meters	Auto
DCU-FUNC-METER-DUS-003	The DCU broadcast upgrades the RS485 meters	Auto
DCU-FUNC-METER-DUS-004	The DCU broadcast upgrades the PLC modules of the meters	Auto

### 3.3.1.19 Test Group Meter Data Collection test

Test Group Information			
Test Group ID	DCU-FUNC-ME-DC	Test Group Name	Meter data collection test
References	<ul style="list-style-type: none"> <li>[12] IESCO_AMI_Project, Technical Specification DCU Companion Specification, V1.4, 2024. Section 5.5 Data Collection Procedures</li> </ul>		
Test Purpose	<ul style="list-style-type: none"> <li>To satisfy the [12] document's requirements and verify DCU collect meter data function is normal</li> </ul>		
Test Setup and Condition	<ul style="list-style-type: none"> <li>Figure 3-15 Test Setup for DCU Function Test</li> </ul>		
Test Method	<ul style="list-style-type: none"> <li>Use automatic method to test the cases.</li> <li>Check if the storing data interface of data collection is normal.</li> <li>Check that reading the storing collection data by the entries is normal.</li> <li>Check that reading the storing collection data by the time is normal.</li> <li>Check that reading the storing collection data by the device serial number is normal.</li> <li>Connect to the DCU by local/remote communication and execute collection tasks immediately or just wait the collection tasks to automatically execute at the scheduled time.</li> <li>After the DCU collect the meters' data, using the software testing tool to read the data from the DCU, and then compare them to the data in meters to see if the result is right.</li> </ul>		
Acceptance Criteria	<ul style="list-style-type: none"> <li>All the test cases of this group execution and pass rates are 100%</li> </ul>		
Test Case Lists			
ID	Case Title	Test Type	
DCU-FUNC-ME-DC-001	Check the storing data interface of data collection	Auto	
DCU-FUNC-ME-DC-002	Check the storing collection data by the entries	Auto	
DCU-FUNC-ME-DC-003	Check the storing collection data by the time	Auto	

DCU-FUNC-ME-DC-004	Check the storing collection data by the device serial number	Auto
DCU-FUNC-ME-DC-005	The DCU collects PLC meters' daily billing data	Auto
DCU-FUNC-ME-DC-006	The DCU collects RS485 meters' daily billing data	Auto
DCU-FUNC-ME-DC-007	The DCU collects PLC meters' monthly billing data	Auto
DCU-FUNC-ME-DC-008	The DCU collects RS485 meters' monthly billing data	Auto
DCU-FUNC-ME-DC-009	The DCU collects PLC meters' load profile data	Auto
DCU-FUNC-ME-DC-010	The DCU collects RS485 meters' load profile data	Auto
DCU-FUNC-ME-DC-011	The DCU collects PLC meters' power quality profile data	Auto
DCU-FUNC-ME-DC-012	The DCU collects RS485 meters' power quality profile data	Auto
DCU-FUNC-ME-DC-013	The DCU collects PLC meters' events data	Auto
DCU-FUNC-ME-DC-014	The DCU collects RS485 meters' events data	Auto

### 3.3.1.20 Test Group DCU Event and Meter Data Report test

Test Group Information			
Test Group ID	DCU-FUNC-ME-DR	Test Group Name	DCU event and meter data report test
References	<ul style="list-style-type: none"> <li>[12] IESCO_AMI_Project, Technical Specification DCU Companion Specification, V1.4, 2024. Section 5.12 Data Push</li> </ul>		
Test Purpose	<ul style="list-style-type: none"> <li>To satisfy the [12] document's requirements and verify DCU data push function is normal</li> </ul>		
Test Setup and Condition	<ul style="list-style-type: none"> <li>Figure 3-15 Test Setup for DCU Function Test</li> </ul>		
Test Method	<ul style="list-style-type: none"> <li>Use partial automatic method to test the cases.</li> <li>When the meters register to the DCU, check if DCU reports the registration data to HES.</li> <li>Let the tasks of collecting meters' data execute immediately and generate some DCU events. After collection data tasks are over and when the DCU events produce, using the HES to check if the data is reported.</li> <li>Generate the meters events, and check if the DCU can transmit them to HES normally.</li> </ul>		
Acceptance Criteria	<ul style="list-style-type: none"> <li>All the test cases of this group execution and pass rates are 100%</li> </ul>		
Test Case Lists			
ID	Case Title		Test Type
DCU-FUNC-DR-001	Check the correctness of the power on event message which the DCU reports		Auto
DCU-FUNC-DR-002	Check the correctness of the last gasp event message which the		Auto

Title:	Interoperability Test Specification	Ver.	2.0	Page:	74 of 103
--------	-------------------------------------	------	-----	-------	-----------

	DCU reports	
DCU-FUNC-DR-003	Check the correctness of the terminal cover open/close event message which the DCU reports	Manual
DCU-FUNC-DR-004	Check the correctness of the top cover open/close event message which the DCU reports	Manual
DCU-FUNC-DR-005	Check the correctness of the meters' events message which the DCU transmits	Manual
DCU-FUNC-DR-006	Check the correctness of the meters' registration information message which the DCU reports	Auto
DCU-FUNC-DR-007	Check the correctness of the meters' daily billing data message which the DCU reports	Auto
DCU-FUNC-DR-008	Check the correctness of the meters' monthly billing data message which the DCU reports	Auto
DCU-FUNC-DR-009	Check the correctness of the meters' load profile data message which the DCU reports	Auto
DCU-FUNC-DR-010	Check the correctness of the meters' power quality profile data message which the DCU reports	Auto
DCU-FUNC-DR-011	Check the correctness of the meters' event profile data message which the DCU reports	Auto

### 3.3.1.21 Test Group DCU RS485 Communication test

Test Group Information			
Test Group ID	DCU-FUNC-485	Test Group Name	DCU RS485 Communication test
References	<ul style="list-style-type: none"> <li>[12] IESCO_AMI_Project, Technical Specification DCU Companion Specification, V1.4, 2024. Section 2.1.3 LAN – Meter Interface (CI1)</li> </ul>		
Test Purpose	<ul style="list-style-type: none"> <li>To satisfy the [12] document's requirements and follow DLMS protocol</li> </ul>		
Test Setup and Condition	<ul style="list-style-type: none"> <li>Figure 3-15 Test Setup for DCU Function Test</li> </ul>		
Test Method	<ul style="list-style-type: none"> <li>Use automatic method to execute the cases.</li> <li>Check the correctness of RS485 communication interface.</li> </ul>		
Acceptance Criteria	<ul style="list-style-type: none"> <li>All the test cases of this group execution and pass rates are 100%</li> </ul>		
Test Case Lists			
ID	Case Title		Test Type
DCU-FUNC-PLC-001	Check RS485 related DLMS Parameters		Auto
DCU-FUNC-PLC-002	RS485 Meter register to the DCU		Auto
DCU-FUNC-PLC-003	RS485 communication success rate		Manual
DCU-FUNC-PLC-004	Check RS485 Topology		Manual

### 3.3.1.22 Test Group DCU Cellular Communication

Test Group Information			
Test Group ID	DCU-FUNC-CELL	Test Group Name	DCU Cellular Communication
References	<ul style="list-style-type: none"> <li>[14] ADB-PDEIP II-Tranche1-AMI Project-IESCO Package-Edit.pdf. Section 6.5.1.2. Communication with HES</li> <li>[12] IESCO_AMI_Project, Technical Specification DCU Companion Specification, V1.4, 2024.</li> </ul>		

Test Purpose	<ul style="list-style-type: none"> <li>To verify DCU LTE-WAN network function is normal</li> </ul>	
Test Setup and Condition	<ul style="list-style-type: none"> <li>Figure 3-15 Test Setup for DCU Function Test</li> <li>A DCU with newest software version, LTE module, Smartset, or Optical device. DCU have registered to HES. The uplink communication is normal</li> </ul>	
Test Method	<ul style="list-style-type: none"> <li>Using partial auto test</li> </ul>	
Acceptance Criteria	<ul style="list-style-type: none"> <li>ALL the test cases are pass</li> </ul>	
Test Case Lists		
ID	Case Title	Test Type
DCU-FUNC-CELL-001	Check the default values of LTE module communication parameters	Auto
DCU-FUNC-CELL-002	Check the read and write permissions, data type, and size ranges of LTE module related parameters	Auto
DCU-FUNC-CELL-003	Check the network connecting mechanism and correctness of network parameters after network access	Auto
DCU-FUNC-CELL-004	Check APN configuration and correct network access	Auto
DCU-FUNC-CELL-005	Check PPP configuration and correct network access	Auto
DCU-FUNC-CELL-006	Check the network type configuration and correct network access	Auto
DCU-FUNC-CELL-007	Check the process of registering the DCU online to the HES	Manual
DCU-FUNC-CELL-008	Check the correctness of remote read (including large packets) and write	Auto
DCU-FUNC-CELL-009	Check the correctness of the push data process	Manual
DCU-FUNC-CELL-010	Check IPv4 and IPv6 network access	Manual
DCU-FUNC-CELL-011	Check the hot swappable module and replace module	Manual
DCU-FUNC-CELL-012	Remote upgrade of DCU	Auto
DCU-FUNC-CELL-013	LTE communication module upgrade	Auto
DCU-FUNC-CELL-014	Check the module supports domain name address resolution	Manual
DCU-FUNC-CELL-015	Check the LTE communication module LED light	Manual
DCU-FUNC-CELL-016	Check the event about LTE communication module	Manual

### 3.3.1.23 Test Group DCU G3 PLC Communication

Test Group Information			
Test Group ID	DCU-FUNC-PLC	Test Group Name	DCU G3 PLC Communication
References	<ul style="list-style-type: none"> <li>[13] IESCO_AMI_Project, Technical Specification Data Concentrator Unit Specification</li> <li>[12] IESCO_AMI_Project, Technical Specification DCU Companion Specification, V1.4, 2024.</li> <li>[15] K. Consortium, OBIS LIST FOR DCU_v1.2.xlsx.</li> <li>[4] IESCO_AMI_Project, dlms_obis_list</li> <li>[2] DLMS User Association, DLMS UA 1000-1 Ed.14, 2020.</li> <li>[8] ITU-T, "ITU-T G.9903: Narrowband orthogonal frequency division multiplexing power line communication transceivers for G3-PLC networks," ITU, 2017.</li> </ul>		
Test Purpose	<ul style="list-style-type: none"> <li>To verify DCU G3 PLC network management function</li> </ul>		
Test Setup and Condition	<ul style="list-style-type: none"> <li>Figure 3-15 Test Setup for DCU Function Test</li> <li>a DCU with newest software version, LTE module, Smartset, ETH wire or</li> </ul>		

	Optical device. DCU have registered to HES. The uplink communication is normal	
Test Method	<ul style="list-style-type: none"> <li>Using partial auto test</li> <li>Analysis the G3 Network sniffer log</li> <li>Power on and down the DUT, makes the meter register to the DUT</li> <li>Triger the network behavior, such as RREQ/PREQ/KICK OFF, etc. from DCU</li> <li>Get the data from meter through DCU G3 network</li> <li>Statistic the communication success rate</li> </ul>	
Acceptance Criteria	<ul style="list-style-type: none"> <li>ALL the test cases is pass</li> </ul>	
Test Case Lists		
ID	Case Title	Test Type
DCU-FUNC-PLC-001	Check PLC related DLMS Parameters	Auto
DCU-FUNC-PLC-002	DCU G3 PLC event	Manual
DCU-FUNC-PLC-003	G3 Meter register to the DCU	Auto
DCU-FUNC-PLC-004	Kick off meter	Auto
DCU-FUNC-PLC-005	G3 PLC communication success rate	Manual
DCU-FUNC-PLC-006	G3 PLC Topology	Manual
DCU-FUNC-PLC-007	Black/White list	Auto
DCU-FUNC-PLC-008	Check PLC default Multicast addr.	Manual
DCU-FUNC-PLC-009	G3 PLC Communication LED indicator	Manual

### 3.3.2 Cellular Performance Test

Consistent with 3.1.2.

### 3.3.3 G3 PLC Performance Test

Consistent with 3.2.2.

### 3.3.4 Integration Test-DCU (CI1,CI2)

This test aims to detect if there is any failures or errors of Integration Test DCU.

### 3.3.4.1 Test Suite

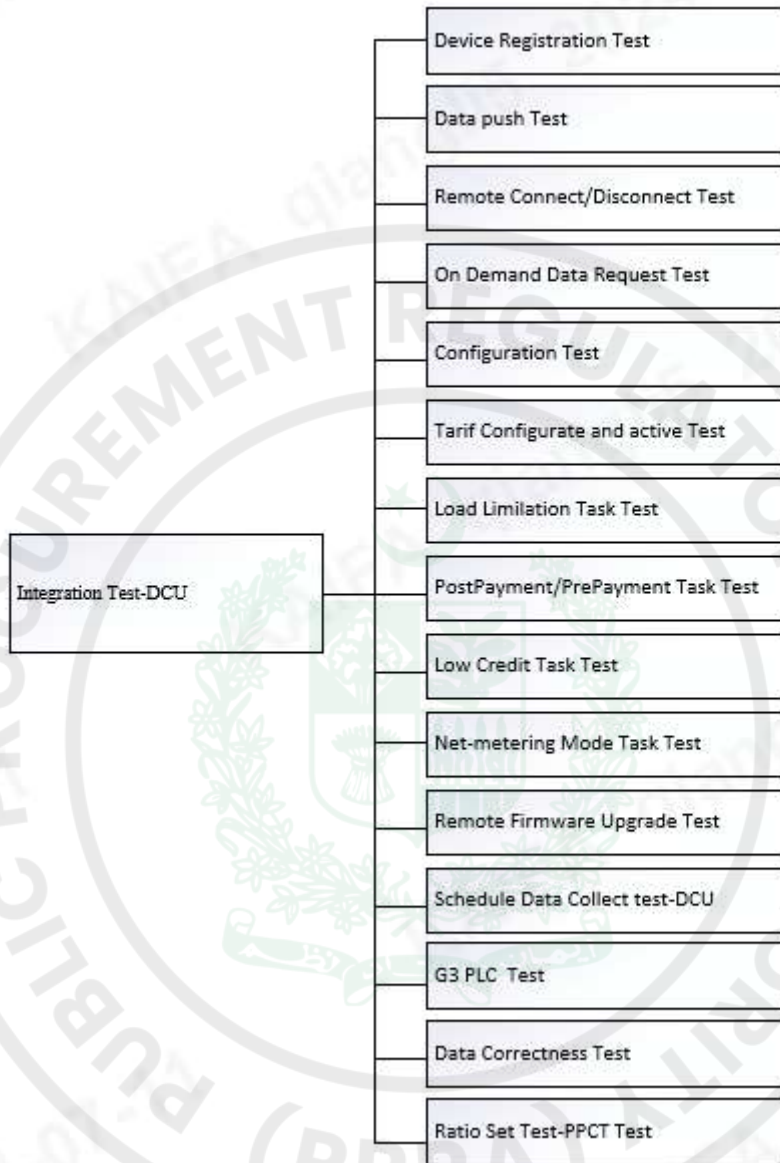

Figure 3-16 DCU Integration Test Setup

No.	Test Group ID	Test Group Name
1	DCU-INTE-REG	Device Registration Test
2	DCU-INTE-PUSH	Data push Test
3	DCU-INTE-RC	Remote Connect/Disconnect Test
4	DCU-INTE-ODO	On Demand Operation
5	DCU-INTE-CFG	Configuration test
6	DCU-INTE-TOU	Tariff Configure and active Test
7	DCU-INTE-LL	Load Limitation Task Test
8	DCU-INTE-PM	Post Payment/Prepayment Task Test
9	DCU-INTE-LC	Low Credit Task Test
10	DCU-INTE-NM	Net-metering Mode Task Test

No.	Test Group ID	Test Group Name
11	DCU-INTE-FU	Remote Firmware Upgrade Test
12	DCU-INTE-DC	Schedule Data Collect test
13	DCU-INTE-COM	G3 PLC Test
14	DCU-INTE-DATA	Data Correctness Test
15	DCU-INTE-RATIO	Ratio Set Test-PPCT

**Table 3-20 Test Group List of DCU Integration Test**

### 3.3.4.2 Test Setup

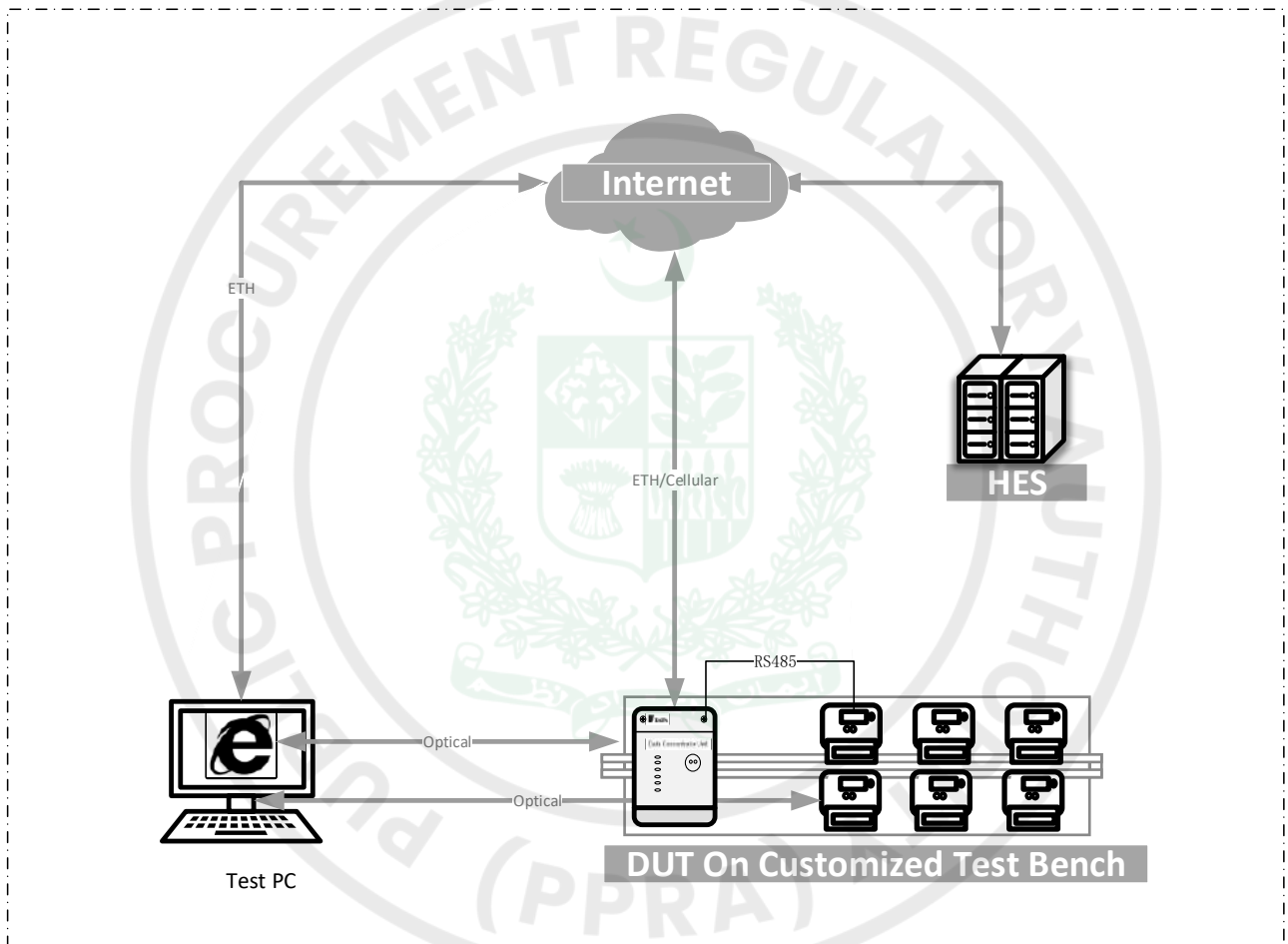

**Figure 3-17 Test Setup for DCU Integration Test**

No.	Device	Qty.	Description
1	DUT	1	DCU PC Connect DCU via Optical/ETH/Cellular Network
2	Meter	3	Auxiliary test equipment, the meters play a role in providing different meter data for DCU to collect or push the data via DCU when they receive commands from the HES Support PLC/RS485/Optical Communication.
3	Test PC	1	The computer is used for providing a place where automatic scripts can run. PC connect DUT via optical/ETH IP/Cellular IP

Title:	Interoperability Test Specification	Ver.	2.0	Page:	79 of 103
--------	-------------------------------------	------	-----	-------	-----------

No.	Device	Qty.	Description
4	Customized Test Bench	1	Auto test software, used to schedule automated test execution
5	HES	1	Head end system
6	Cellular Network	-	<ul style="list-style-type: none"> <li>• IESCO provided</li> <li>• Support GPRS and LTE</li> <li>• Support verify the APN (Access Point Name)</li> <li>• Support verify the PPP information</li> <li>• Support IPv4/v6</li> </ul>

**Table 3-21 Test Setup for DCU Function Test**

### 3.3.4.3 Test Group Device Registration

Test Group Information			
Test Group ID	DCU-INTE-REG	Test Group Name	Device Registration
References	<ul style="list-style-type: none"> <li>• [1] IESCO_AMI_Project, Technical Specification Smart Meter Companion Specification</li> <li>• [2] DLMS User Association, DLMS UA 1000-1 Ed.14, 2020.</li> <li>• [13] IESCO_AMI_Project, Technical Specification Data Concentrator Unit Specification</li> </ul>		
Test Purpose	<ul style="list-style-type: none"> <li>• Verify the device register</li> </ul>		
Test Setup and Condition	<ul style="list-style-type: none"> <li>• The DUT function test is pass</li> <li>• Figure 3-17 Test Setup for DCU Integration Test</li> </ul>		
Test Method	Manually test <ul style="list-style-type: none"> <li>• Configure the DUT archive in HES</li> <li>• Power on and check if the Meter register to the DCU and HES</li> </ul>		
Acceptance Criteria	<ul style="list-style-type: none"> <li>• All the test case of this group is pass</li> </ul>		
Test Case Lists			
ID	Case Title		
DCU-INTE-REG-001	Device Registration Test-DCU		
DCU-INTE-REG-002	Device Registration Test-PLC Meter		
DCU-INTE-REG-003	Device Registration Test-485 Meter		

### 3.3.4.4 Test Group Meter Alarm/Event

Test Group Information			
Test Group ID	DCU-INTE-PUSH	Test Group Name	Data push Test-Meter Alarm/Event
References	<ul style="list-style-type: none"> <li>• [1] IESCO_AMI_Project, Technical Specification Smart Meter Companion Specification</li> <li>• [2] DLMS User Association, DLMS UA 1000-1 Ed.14, 2020.</li> <li>• [13] IESCO_AMI_Project, Technical Specification Data Concentrator Unit Specification</li> </ul>		
Test Purpose	<ul style="list-style-type: none"> <li>• Verify the DUT could push event/alarm correctly to HES.</li> </ul>		
Test Setup and Condition	<ul style="list-style-type: none"> <li>• The DUT function test is pass</li> <li>• Figure 3-17 Test Setup for DCU Integration Test</li> </ul>		
Test Method	Manually test		

	<ul style="list-style-type: none"> <li>Trigger the DUT push event/alarm and check if it has been pushed to HES.</li> </ul>
Acceptance Criteria	<ul style="list-style-type: none"> <li>All the test case of this group is pass</li> </ul>
Test Case Lists	
ID	Case Title
DCU-INTE-PUSH-001	Data push Test-DCU Alarm/Event
DCU-INTE-PUSH-002	Data push Test-Meter Alarm/Event
DCU-INTE-PUSH-003	Data push Test-Collected Meter Data
DCU-INTE-PUSH-004	Data push Test-G3 Topology

### 3.3.4.5 Test Group Remote Connect/Disconnect Test

Test Group Information			
Test Group ID	DCU-INTE-RC	Test Group Name	Remote Connect/Disconnect Test
References	<ul style="list-style-type: none"> <li>[1] IESCO_AMI_Project, Technical Specification Smart Meter Companion Specification</li> <li>[2] DLMS User Association, DLMS UA 1000-1 Ed.14, 2020.</li> <li>[13] IESCO_AMI_Project, Technical Specification Data Concentrator Unit Specification</li> </ul>		
Test Purpose	<ul style="list-style-type: none"> <li>Verify the remote connect/Disconnect meter works well</li> </ul>		
Test Setup and Condition	<ul style="list-style-type: none"> <li>The DUT function test is pass</li> <li>Figure 3-17 Test Setup for DCU Integration Test</li> </ul>		
Test Method	Manually test <ul style="list-style-type: none"> <li>Perform the remote connect/disconnect operation on the HES, and check if the meter action correctly.</li> </ul>		
Acceptance Criteria	<ul style="list-style-type: none"> <li>All the test case of this group is pass</li> </ul>		
Test Case Lists			
ID	Case Title		
DCU-INTE-RC-001	Remote connect Meter		
DCU-INTE-RC-002	Remote disconnect Meter		

### 3.3.4.6 Test Group On Demand Data Request Test

Test Group Information			
Test Group ID	DCU-INTE-ODO	Test Group Name	On Demand Data Request Test
References	<ul style="list-style-type: none"> <li>[1] IESCO_AMI_Project, Technical Specification Smart Meter Companion Specification</li> <li>[2] DLMS User Association, DLMS UA 1000-1 Ed.14, 2020.</li> <li>[3] DLMS User Association, DLMS UA 1000-2 Ed.10, 2020.</li> <li>[7] IESCO_AMI_Project, Technical Specification Head End System</li> <li>[13] IESCO_AMI_Project, Technical Specification Data Concentrator Unit Specification</li> </ul>		
Test Purpose	<ul style="list-style-type: none"> <li>Verify the on-demand data request could be performed correctly</li> </ul>		
Test Setup and Condition	<ul style="list-style-type: none"> <li>The DUT function test is pass</li> <li>Figure 3-17 Test Setup for DCU Integration Test</li> </ul>		

Title:	Interoperability Test Specification	Ver.	2.0	Page:	81 of 103
--------	-------------------------------------	------	-----	-------	-----------

Test Method	Manually test <ul style="list-style-type: none"> <li>Perform the on-demand request, and check the data.</li> </ul>
Acceptance Criteria	<ul style="list-style-type: none"> <li>All the test case of this group is pass</li> </ul>
Test Case Lists	
ID	Case Title
DCU-INTE-ODO-001	On Demand Data Request Test-Meter
DCU-INTE-ODO-002	On Demand Data Request Test-DCU

### 3.3.4.7 Test Group Configuration test

Test Group Information			
Test Group ID	DCU-INTE-CFG	Test Group Name	Configuration test
References	<ul style="list-style-type: none"> <li>[1] IESCO_AMI_Project, Technical Specification Smart Meter Companion Specification</li> <li>[2] DLMS User Association, DLMS UA 1000-1 Ed.14, 2020.</li> <li>[3] DLMS User Association, DLMS UA 1000-2 Ed.10, 2020.</li> <li>[7] IESCO_AMI_Project, Technical Specification Head End System</li> <li>[13] IESCO_AMI_Project, Technical Specification Data Concentrator Unit Specification</li> </ul>		
Test Purpose	<ul style="list-style-type: none"> <li>Verify the configure the meter's parameter</li> </ul>		
Test Setup and Condition	<ul style="list-style-type: none"> <li>The DUT function test is pass</li> <li>Figure 3-17 Test Setup for DCU Integration Test</li> </ul>		
Test Method	Manually test <ul style="list-style-type: none"> <li>Configure the meter's parameter from HES.</li> </ul>		
Acceptance Criteria	<ul style="list-style-type: none"> <li>All the test case of this group is pass</li> </ul>		
Test Case Lists			
ID	Case Title		
DCU-INTE-CFG-001	Configuration test-DCU		
DCU-INTE-CFG-001	Configuration test-Meter		

### 3.3.4.8 Test Group Tariff Configure and active Test

Test Group Information			
Test Group ID	DCU-INTE-TOU	Test Group Name	Tariff Configure and active Test
References	<ul style="list-style-type: none"> <li>[1] IESCO_AMI_Project, Technical Specification Smart Meter Companion Specification</li> <li>[2] DLMS User Association, DLMS UA 1000-1 Ed.14, 2020.</li> <li>[3] DLMS User Association, DLMS UA 1000-2 Ed.10, 2020.</li> <li>[7] IESCO_AMI_Project, Technical Specification Head End System</li> <li>[13] IESCO_AMI_Project, Technical Specification Data Concentrator Unit Specification</li> </ul>		
Test Purpose	<ul style="list-style-type: none"> <li>Verify the tariff configure and active with different manufactory Meters and HES</li> </ul>		
Test Setup and Condition	<ul style="list-style-type: none"> <li>The DUT function test is pass</li> <li>Figure 3-17 Test Setup for DCU Integration Test</li> </ul>		
Test Method	Manually test		

Title:	Interoperability Test Specification	Ver.	2.0	Page:	82 of 103
--------	-------------------------------------	------	-----	-------	-----------

	<ul style="list-style-type: none"> <li>Configure and active tariff from the HES</li> </ul>
Acceptance Criteria	<ul style="list-style-type: none"> <li>All the test case of this group is pass</li> </ul>
Test Case Lists	
ID	Case Title
DCU-INTE-TOU-001	Tariff Configure and active Test

### 3.3.4.9 Test Group Load Limitation Task Test

Test Group Information			
Test Group ID	DCU-INTE-LL	Test Group Name	Load Limitation Task Test
References	<ul style="list-style-type: none"> <li>[1] IESCO_AMI_Project, Technical Specification Smart Meter Companion Specification</li> <li>[2] DLMS User Association, DLMS UA 1000-1 Ed.14, 2020.</li> <li>[3] DLMS User Association, DLMS UA 1000-2 Ed.10, 2020.</li> <li>[7] IESCO_AMI_Project, Technical Specification Head End System</li> <li>[13] IESCO_AMI_Project, Technical Specification Data Concentrator Unit Specification</li> </ul>		
Test Purpose	<ul style="list-style-type: none"> <li>Verify the load limitation with different manufactory Meters and HES</li> </ul>		
Test Setup and Condition	<ul style="list-style-type: none"> <li>The DUT function test is pass</li> <li>Figure 3-17 Test Setup for DCU Integration Test</li> </ul>		
Test Method	Manually test <ul style="list-style-type: none"> <li>Configure and active the Load Limitation from the HES. Check if it is work.</li> </ul>		
Acceptance Criteria	<ul style="list-style-type: none"> <li>All the test case of this group is pass</li> </ul>		
Test Case Lists			
ID	Case Title		
DCU-INTE-LL-001	Load Limitation Task Test		

### 3.3.4.10 Test Group Post Payment/Prepayment Task Test

Test Group Information			
Test Group ID	DCU-INTE-PM	Test Group Name	Post Payment/Prepayment Task Test
References	<ul style="list-style-type: none"> <li>[1] IESCO_AMI_Project, Technical Specification Smart Meter Companion Specification</li> <li>[2] DLMS User Association, DLMS UA 1000-1 Ed.14, 2020.</li> <li>[3] DLMS User Association, DLMS UA 1000-2 Ed.10, 2020.</li> <li>[7] IESCO_AMI_Project, Technical Specification Head End System</li> <li>[13] IESCO_AMI_Project, Technical Specification Data Concentrator Unit Specification</li> </ul>		
Test Purpose	<ul style="list-style-type: none"> <li>Verify the Post Payment/Prepayment Task integration with different manufactory Meters and HES</li> </ul>		
Test Setup and Condition	<ul style="list-style-type: none"> <li>The DUT function test is pass</li> <li>Figure 3-17 Test Setup for DCU Integration Test</li> </ul>		
Test Method	Manually test <ul style="list-style-type: none"> <li>Configure Post Payment/Prepayment Task from the HES. Check if it is work.</li> </ul>		
Acceptance Criteria	<ul style="list-style-type: none"> <li>All the test case of this group is pass</li> </ul>		
Test Case Lists			
ID	Case Title		
DCU-INTE-PM-001	Post Payment/Prepayment Task Test		

### 3.3.4.11 Test Group Low Credit Task Test

Test Group Information			
Test Group ID	DCU-INTE-LC	Test Group Name	Low Credit Task Test
References	<ul style="list-style-type: none"> <li>[1] IESCO_AMI_Project, Technical Specification Smart Meter Companion Specification</li> <li>[2] DLMS User Association, DLMS UA 1000-1 Ed.14, 2020.</li> <li>[3] DLMS User Association, DLMS UA 1000-2 Ed.10, 2020.</li> <li>[7] IESCO_AMI_Project, Technical Specification Head End System</li> <li>[13] IESCO_AMI_Project, Technical Specification Data Concentrator Unit Specification</li> </ul>		
Test Purpose	<ul style="list-style-type: none"> <li>Verify the Low Credit Task integration with different manufactory Meters and HES</li> </ul>		
Test Setup and Condition	<ul style="list-style-type: none"> <li>The DUT function test is pass</li> <li>Figure 3-17 Test Setup for DCU Integration Test</li> </ul>		
Test Method	Manually test <ul style="list-style-type: none"> <li>Configure the Low Credit Task from the HES and check if it works</li> </ul>		
Acceptance Criteria	<ul style="list-style-type: none"> <li>All the test case of this group is pass</li> </ul>		
Test Case Lists			
ID	Case Title		
DCU-INTE-LC-001	Low Credit Task Test		

### 3.3.4.12 Test Group Net-metering Mode Task Test

Test Group Information			
Test Group ID	DCU-INTE-NM	Test Group Name	Net-metering Mode Task Test
References	<ul style="list-style-type: none"> <li>[1] IESCO_AMI_Project, Technical Specification Smart Meter Companion Specification</li> <li>[2] DLMS User Association, DLMS UA 1000-1 Ed.14, 2020.</li> <li>[3] DLMS User Association, DLMS UA 1000-2 Ed.10, 2020.</li> <li>[7] IESCO_AMI_Project, Technical Specification Head End System</li> <li>[13] IESCO_AMI_Project, Technical Specification Data Concentrator Unit Specification</li> </ul>		
Test Purpose	<ul style="list-style-type: none"> <li>Verify the integration Net-metering Mode Task with DUT and different manufactory Meters and HES</li> </ul>		
Test Setup and Condition	<ul style="list-style-type: none"> <li>The DUT function test is pass</li> <li>Figure 3-17 Test Setup for DCU Integration Test</li> </ul>		
Test Method	Manually test <ul style="list-style-type: none"> <li>Configure the Net-metering Mode Task from the HES, check if it works.</li> </ul>		
Acceptance Criteria	<ul style="list-style-type: none"> <li>All the test case of this group is pass</li> </ul>		
Test Case Lists			
ID	Case Title		
DCU-INTE-NM -001	Net-metering Mode Task Test		

### 3.3.4.13 Test Group Remote Firmware Upgrade Test

Test Group Information			
Test Group ID	DCU-INTE-FU	Test Group Name	Remote Firmware Upgrade Test
References	<ul style="list-style-type: none"> <li>[1] IESCO_AMI_Project, Technical Specification Smart Meter Companion Specification</li> <li>[2] DLMS User Association, DLMS UA 1000-1 Ed.14, 2020.</li> <li>[3] DLMS User Association, DLMS UA 1000-2 Ed.10, 2020.</li> <li>[7] IESCO_AMI_Project, Technical Specification Head End System</li> <li>[13] IESCO_AMI_Project, Technical Specification Data Concentrator Unit Specification</li> </ul>		
Test Purpose	<ul style="list-style-type: none"> <li>Verify DUT Firmware upgrade test integration with different manufactory Meters and HES</li> </ul>		
Test Setup and Condition	<ul style="list-style-type: none"> <li>The DUT function test is pass</li> <li>Figure 3-17 Test Setup for DCU Integration Test</li> </ul>		
Test Method	Manually test <ul style="list-style-type: none"> <li>Configure the Remote Firmware Upgrade Task from the HES. Check if it is work.</li> </ul>		
Acceptance Criteria	<ul style="list-style-type: none"> <li>All the test case of this group is pass</li> </ul>		
Test Case Lists			
ID	Case Title		
DCU-INTE-FU-001	Remote Firmware Upgrade Test-Unicast Update Meter-SP PLC		
DCU-INTE-FU-002	Remote Firmware Upgrade Test-Unicast Update Meter-PPDC PLC		
DCU-INTE-FU-003	Remote Firmware Upgrade Test-Unicast Update Meter-PPCT PLC		
DCU-INTE-FU-004	Remote Firmware Upgrade Test-Unicast Update Meter-RS485		
DCU-INTE-FU-005	Remote Firmware Upgrade Test-Unicast Update G3PLC Module		
DCU-INTE-FU-006	Remote Firmware Upgrade Test-Broadcast Update Meter-SP PLC		
DCU-INTE-FU-007	Remote Firmware Upgrade Test-Broadcast Update Meter-PPDC PLC		
DCU-INTE-FU-008	Remote Firmware Upgrade Test-Broadcast Update Meter-PPCT PLC		
DCU-INTE-FU-009	Remote Firmware Upgrade Test-Broadcast Update G3 PLC Module		

### 3.3.4.14 Test Group Schedule Data Collect test

Test Group Information			
Test Group ID	DCU-INTE-DC	Test Group Name	Schedule Data Collect test-DCU
References	<ul style="list-style-type: none"> <li>[1] IESCO_AMI_Project, Technical Specification Smart Meter Companion Specification</li> <li>[2] DLMS User Association, DLMS UA 1000-1 Ed.14, 2020.</li> <li>[3] DLMS User Association, DLMS UA 1000-2 Ed.10, 2020.</li> <li>[7] IESCO_AMI_Project, Technical Specification Head End System</li> <li>[13] IESCO_AMI_Project, Technical Specification Data Concentrator Unit Specification</li> </ul>		
Test Purpose	<ul style="list-style-type: none"> <li>Verify the Up-Stream Schedule Data Collect test integration with different manufactory Meters and HES</li> </ul>		
Test Setup and Condition	<ul style="list-style-type: none"> <li>The DUT function test is pass</li> <li>Figure 3-17 Test Setup for DCU Integration Test</li> </ul>		

Test Method	Manually test <ul style="list-style-type: none"> <li>Configure Schedule Data Collect Test Task from the HES/DCU. Check if it is work.</li> </ul>
Acceptance Criteria	<ul style="list-style-type: none"> <li>All the test case of this group is pass</li> </ul>
Test Case Lists	
ID	Case Title
DCU-INTE-DC-001	Schedule Data Collect test-DCU
DCU-INTE-DC-002	Schedule Data Collect test-HES

### 3.3.4.15 Test Group G3 PLC Test

Test Group Information			
Test Group ID	DCU-INTE-COM	Test Group Name	G3 PLC
References	<ul style="list-style-type: none"> <li>[1] IESCO_AMI_Project, Technical Specification Smart Meter Companion Specification</li> <li>[2] DLMS User Association, DLMS UA 1000-1 Ed.14, 2020.</li> <li>[3] DLMS User Association, DLMS UA 1000-2 Ed.10, 2020.</li> <li>[7] IESCO_AMI_Project, Technical Specification Head End System</li> <li>[13] IESCO_AMI_Project, Technical Specification Data Concentrator Unit Specification</li> </ul>		
Test Purpose	<ul style="list-style-type: none"> <li>Verify the G3 PLC integration with different manufactory DCU /HES</li> </ul>		
Test Setup and Condition	<ul style="list-style-type: none"> <li>The DUT function test is pass</li> <li>Figure 3-17 Test Setup for DCU Integration Test</li> </ul>		
Test Method	Manually test <ul style="list-style-type: none"> <li>Trigger the G3 PLC network behavior.</li> </ul>		
Acceptance Criteria	<ul style="list-style-type: none"> <li>All the test case of this group is pass</li> </ul>		
Test Case Lists			
ID	Case Title		
DCU-INTE-COM-001	Phase Detection		
DCU-INTE-COM-002	Black/White List		
DCU-INTE-COM-003	Unregister Meter		

### 3.3.4.16 Test Group Data Correctness Test

Test Group Information			
Test Group ID	DCU-INTE-DATA	Test Group Name	Data Correctness Test
References	<ul style="list-style-type: none"> <li>[1] IESCO_AMI_Project, Technical Specification Smart Meter Companion Specification</li> <li>[2] DLMS User Association, DLMS UA 1000-1 Ed.14, 2020.</li> <li>[3] DLMS User Association, DLMS UA 1000-2 Ed.10, 2020.</li> <li>[7] IESCO_AMI_Project, Technical Specification Head End System</li> <li>[13] IESCO_AMI_Project, Technical Specification Data Concentrator Unit Specification</li> </ul>		
Test Purpose	<ul style="list-style-type: none"> <li>Verify the Data Correctness</li> </ul>		
Test Setup and Condition	<ul style="list-style-type: none"> <li>The DUT function test is pass</li> <li>Figure 3-17 Test Setup for DCU Integration Test</li> </ul>		

Title:	Interoperability Test Specification	Ver.	2.0	Page:	87 of 103
--------	-------------------------------------	------	-----	-------	-----------

Test Method	Manually test <ul style="list-style-type: none"> <li>Check if data correctness by compare the meter's data both HES and DCU.</li> </ul>
Acceptance Criteria	<ul style="list-style-type: none"> <li>All the test case of this group is pass</li> </ul>
Test Case Lists	
ID	Case Title
DCU-INTE-DATA-001	Data Correctness Test

### 3.3.4.17 Test Group Ratio Set Test-PPCT

Test Group Information			
Test Group ID	DCU-INTE-RATIO	Test Group Name	Ratio Set Test-PPCT
References	<ul style="list-style-type: none"> <li>[1] IESCO_AMI_Project, Technical Specification Smart Meter Companion Specification</li> <li>[2] DLMS User Association, DLMS UA 1000-1 Ed.14, 2020.</li> <li>[3] DLMS User Association, DLMS UA 1000-2 Ed.10, 2020.</li> <li>[7] IESCO_AMI_Project, Technical Specification Head End System</li> <li>[13] IESCO_AMI_Project, Technical Specification Data Concentrator Unit Specification</li> </ul>		
Test Purpose	<ul style="list-style-type: none"> <li>Verify the Ratio Set Test-PPCT</li> </ul>		
Test Setup and Condition	<ul style="list-style-type: none"> <li>The DUT function test is pass</li> <li>Figure 3-17 Test Setup for DCU Integration Test</li> <li>DUT is PPCT</li> </ul>		
Test Method	Manually test <ul style="list-style-type: none"> <li>Configure t Ratio Set Test-PPCT Task from the HES/DCU. Check if it is work</li> </ul>		
Acceptance Criteria	<ul style="list-style-type: none"> <li>All the test case of this group is pass</li> </ul>		
Test Case Lists			
ID	Case Title		
DCU-INTE-RATIO-001	Ratio Set Test-PPCT		

### 3.4 HES

#### 3.4.1 Integration Test-MDMS to HES (CIM)

This test aims to verify HES SI2 interface functionality to complete the integration. Empower Test is the test tool to make the integration test with the new HES system following the CIM specification defined by IESCO.

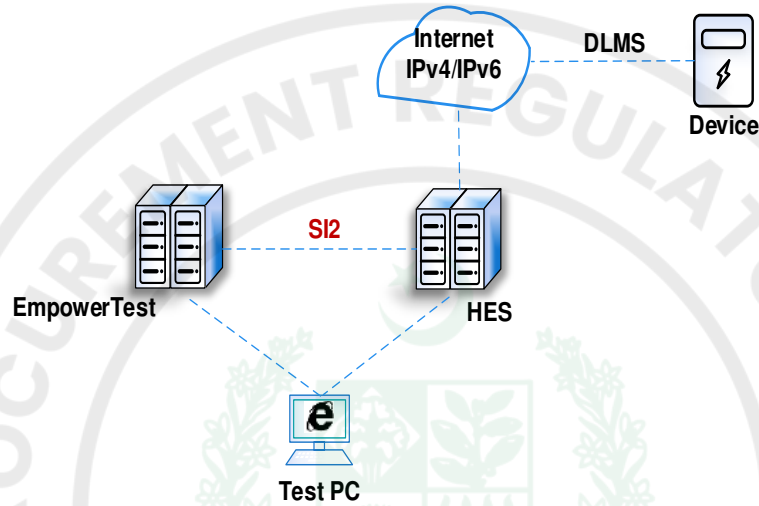

Figure 3-18 System Integration Framework

Figure 3-18 shows the system integration framework. Empower HES is connected to the new HES system, and the new HES system should be connected with the devices via Internet.

##### 3.4.1.1 Test Pre-condition

The HES interface integration test will be carried out while the following test instruments should be ready.

No.	Instrument	Condition
1	HES System	Deployed by the supplier and can be connected by LAB instrument.
2	Device Under Test	Real DUT or simulator which is working normally with test HES
3	Test PC	Working normally with Internet access
4	Empower Test Tool	Can be connected with test HES

Table 3-22 CIM Test Pre-condition

##### 3.4.1.2 Test Suite

According to the interface data flow direction, the test cases are divided into three groups. One group is for system file integration and does not involve electric meter equipment; the second group is for HES command execution, and the third group is for HES to actively report data.

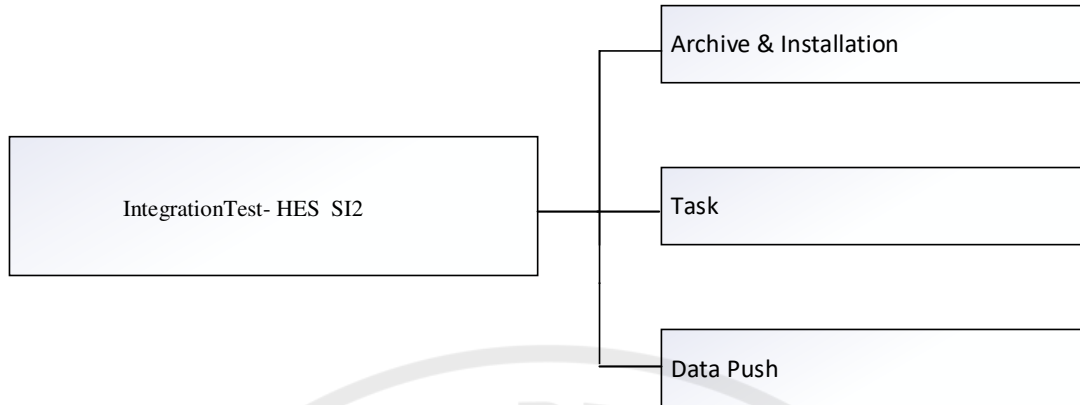

Figure 3-19 System Integration Test Group

Test Group ID	Test Group Name
TG-001	Archive & Installation
TG-002	Task
TG-003	Data Push

Table 3-23 Device List

### 3.4.1.3 TG-001 Archive & Installation

Test Group Information	
Test Group ID	TG-001      Test Group Name      Archive & Installation
References	<ul style="list-style-type: none"> <li>[16] IESCO_AMI_Project, CIM Specification</li> </ul>
Test Purpose	<ul style="list-style-type: none"> <li>This section aims at presenting message structures regarding information exchange from or to HES.</li> </ul>
Test Setup & Condition	<ul style="list-style-type: none"> <li>All HES services run normally.</li> <li>Communication between the test PC and the server is normal.</li> </ul>
Test Method	<div style="display: flex; justify-content: space-around;"> <div style="text-align: center;"> <p>EmpowerTest      HES</p> </div> <div style="text-align: center;"> <p>EmpowerTest      HES</p> </div> </div> <p>Region: create, delete,modifiedDevice Archive: create, delete,modified</p> <p style="text-align: right;">Module Info Updating</p> <ol style="list-style-type: none"> <li>Partial automatic test, Partial Manually test</li> <li>For Region Info, the Empower Test will call the HES interface to add, modify, and delete regions, and then check that the corresponding regions of HES are updated synchronously.</li> <li>For Device archive, the Empower Test will call the HES interface to add, modify, and delete meter/DCU archives, and then check that the corresponding archives of HES are updated synchronously.</li> <li>For Module updating, the test case will simulate HES to call the interface to synchronize module information about device, and then check the response data as expected.</li> </ol>

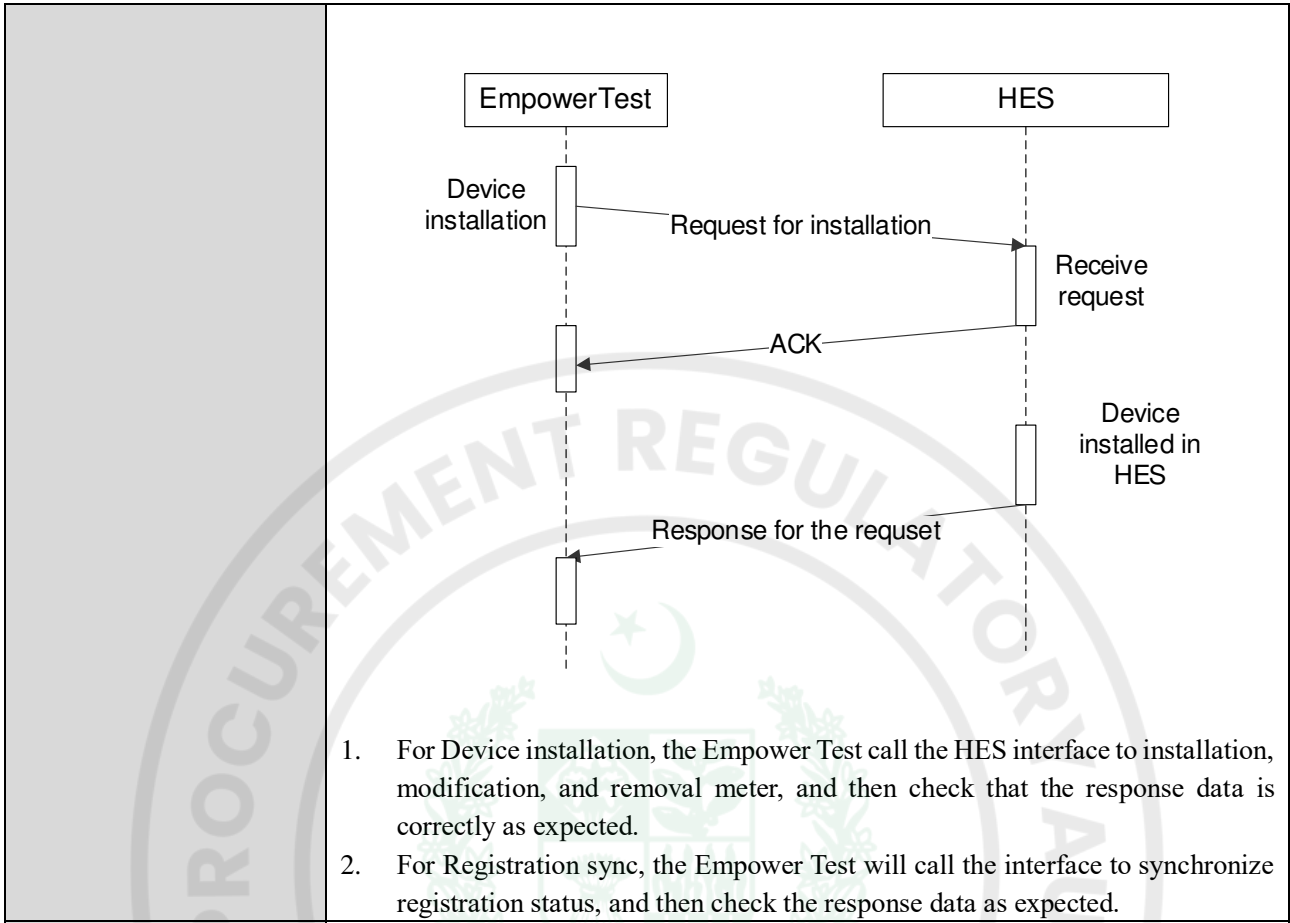

1. For Device installation, the Empower Test call the HES interface to installation, modification, and removal meter, and then check that the response data is correctly as expected.
2. For Registration sync, the Empower Test will call the interface to synchronize registration status, and then check the response data as expected.

**Acceptance Criteria**

The test cases will result in the following verdicts:

- **Passed:** The interface complies with all the acceptance criteria.
- **Failed:** The interface does not meet one or more acceptance criteria and needs to be verified after rectification, change points are provided, and relevant test items need to be retested to evaluate.

Test Case Lists	
ID	Case Title
TG-001-001	Region Info
TG-001-002	Device Archive
TG-001-003	Module Info Updating
TG-001-004	Meter Installation
TG-001-005	DCU Installation
TG-001-006	Registration Synchronization

**3.4.1.4 TG-002 Task**

Test Group Information			
Test Group ID	TG-002	Test Group Name	Task
References	<ul style="list-style-type: none"> <li>• [16] IESCO_AMI_Project, CIM Specification</li> <li>• [1] IESCO_AMI_Project, Technical Specification Smart Meter Companion Specification</li> <li>• [7] IESCO_AMI_Project, Technical Specification Head End System</li> </ul>		
Test Purpose	<ul style="list-style-type: none"> <li>• This group is aims to verify that HES can correctly receive the CIM code</li> </ul>		

	defined by the interface and perform corresponding actions
Test Setup And Condition	<ul style="list-style-type: none"> <li>HES service is running normally</li> </ul>
Test Method	<pre> sequenceDiagram     participant EmpowerTest     participant HES     EmpowerTest-&gt;&gt;HES: CIM request     HES--&gt;&gt;EmpowerTest: ACK     HES-&gt;&gt;HES: Operations execution     HES--&gt;&gt;EmpowerTest: CIM response     </pre> <ul style="list-style-type: none"> <li>Automatic test</li> <li>For CIM task, the Empower Test call the HES interface to send CIM commands, HES receive the commands, will do some own operations, after that, HES will send the response to Empower Test. Lastly, the Empower Test will check the task result and response data is correctly as expected.</li> </ul>
Acceptance Criteria	<p>The test cases will result in the following verdicts:</p> <ul style="list-style-type: none"> <li><b>Passed:</b> The interface complies with all the acceptance criteria.</li> <li><b>Failed:</b> The interface does not meet one or more acceptance criteria and needs to be verified after rectification, change points are provided, and relevant test items need to be retested to evaluate.</li> </ul>

Test Case Lists	
ID	Case Title
TG-002-001	Relay Control Task Test
TG-002-002	Tariff Task Test
TG-002-003	Load Limitation Task Test
TG-002-004	Top Up Task Test
TG-002-005	Post Payment/Prepayment Task Test
TG-002-006	Key Change Task Test
TG-002-007	Low Credit Task Test
TG-002-008	Net-metering Mode Task Test
TG-002-009	Meter Reading Test
TG-002-010	Event Reading Test
TG-002-011	Device Parameter Synchronization Test

### 3.4.1.5 TG-003 Data Push

Test Group Information	
Test Group ID	TG-003
Test Group Name	Data Push
References	<ul style="list-style-type: none"> <li>[16] IESCO_AMI_Project, CIM Specification</li> <li>[1] IESCO_AMI_Project, Technical Specification Smart Meter Companion Specification</li> <li>[7] IESCO_AMI_Project, Technical Specification Head End System</li> </ul>
Test Purpose	This group is aims to verify that Daily profile, monthly profile, load profile and power quality profile and event will be pushed from HES.
Test Setup & Condition	<ul style="list-style-type: none"> <li>All HES services run normally.</li> <li>Communication between the test PC and the server is normal.</li> </ul>
Test Method	<pre> sequenceDiagram     participant EmpowerTest     participant HES     EmpowerTest-&gt;&gt;HES: Trigger the HES to report data     HES-&gt;&gt;Kafka: Push data to Kafka     EmpowerTest-&gt;&gt;Kafka: Push data to Kafka     EmpowerTest-&gt;&gt;Kafka: Check kafka data     </pre> <ul style="list-style-type: none"> <li>Partial automatic test, Partial Manually test</li> <li>For data push flow, the Empower Test triggers the HES to report data, and then consumes Kafka messages, and checks whether the data is the same as what HES pushes.</li> </ul>
Acceptance Criteria	<p>The test cases will result in the following verdicts:</p> <ul style="list-style-type: none"> <li><b>Passed:</b> The interface complies with all the acceptance criteria.</li> <li><b>Failed:</b> The interface does not meet one or more acceptance criteria and needs to be verified after rectification, change points are provided, and relevant test items need to be retested to evaluate.</li> </ul>
Test Case Lists	
ID	Case Title
TG-003-001	Metering Data Push Test
TG-003-002	Event Push Test

### 3.5 PLC filter function test

Verify the functional integrity and performance of the product, the test items are as follows:

- Noise attenuation test
- Power consumption test

#### 3.5.1 Noise attenuation test

##### 3.5.1.1 Test Initiation Criteria

Ambient temperature: 15°C to 35°C;

Ambient relative humidity: 45% to 75%;

Air pressure: 86 kPa to 106 kPa.

##### 3.5.1.2 Test Setup

Refer to the diagram below to set up the testing environment for the filter:

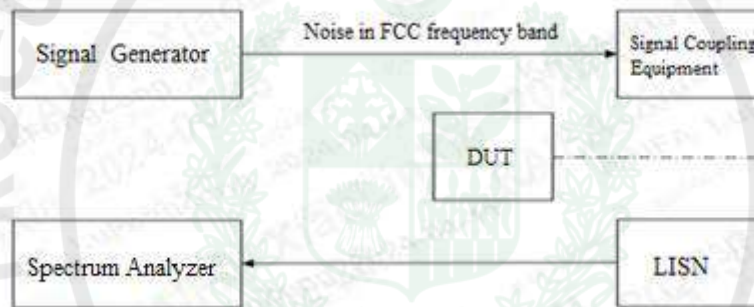

Figure 4-20 Test Setup for PLC filter Function test

Information for measurement equipment:

No	Device name	Qty.	Description
1	Arbitrary Function Generator	1	Generator noise wave in FCC frequency band
2	Spectrum Analyzer	1	Display signal spectrum characteristics
3	LISN	1	Artificial mains network
4	Signal Coupling Equipment	1	Isolation of noise from AC power, output noise signal
5	Variable Frequency Power Supply	1	AC power input, output stable 230V 50Hz power, to avoid AC voltage change. Recommended model: ANFC015T
6	Isolated Power	1	Isolate AC power and DUT power supply, to avoid other signal transmission through AC power, without pass the LISN and Attenuator.

Table 4-24 Test Setup for PLC filter function test

### 3.5.1.3 Test case information

Test Case Information			
Test Case ID	Filter FCT-001	Test Case Name	Noise attenuation test
References	<ul style="list-style-type: none"> <li>[17] IESCO_AMI_Project, Technical Specification PLC Filter Specification for single phase meter</li> <li>[18] IESCO_AMI_Project, Technical Specification PLC Filter Specification for three phase meters</li> </ul>		
Test Purpose	Verify the noise attenuation performance of the product.		
Test Setup and Condition	<ul style="list-style-type: none"> <li>Test voltage: Un for voltage circuit;</li> <li>Noise is emitted by signal generator and read spectrum analyzer, compare the noise before and after DUT is connected to the power grid.</li> </ul>		
Acceptance Criteria	The attenuation of EUT is $\geq 15$ dB in FCC Frequency		
Procedures	Step No.	Action	Output
	1	Use signal generator send out a noise waveform in FCC frequency, coupling the signal into the LISN by RF couple, record the maximum amplitude of the waveform in Spectrum Analyzer.	Record the maximum amplitude of the waveform.
	2	Add filter in test system redo step 1, record the maximum amplitude of the waveform in Spectrum Analyzer.	Record the maximum amplitude of the waveform.
	3	Calculate the difference value between step 1 and step 2.	The attenuation value

### 3.5.2 Power consumption test

#### 3.5.2.1 Test Initiation Criteria

Ambient temperature: 15°C to 35°C;  
 Ambient relative humidity: 45% to 75%;  
 Air pressure: 86 kPa to 106 kPa.

#### 3.5.2.2 Test Setup

The DUT connected to the power analyzer, as show in the following figure:

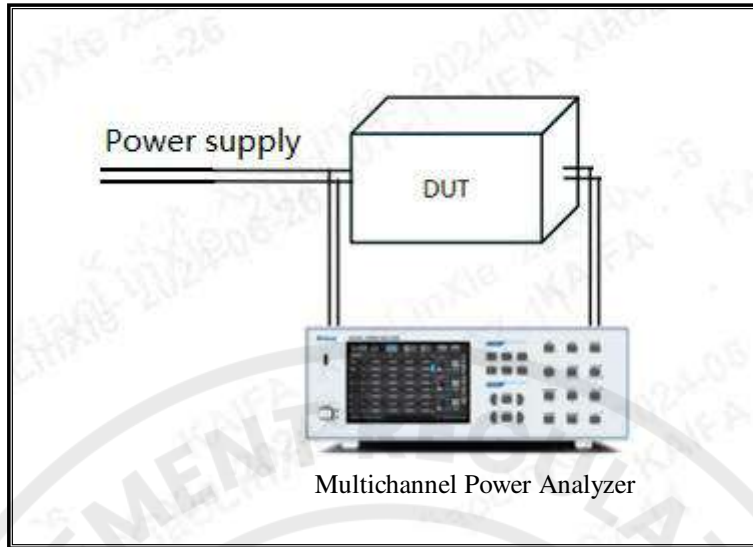

Figure 4-21 Test Setup for PLC filter power consumption test

Information for measurement equipment:

No	Device name	Qty.	Description
1	Multichannel Power Analyzer	1	Power consumption test

Table 4-25 Test Setup for PLC filter power consumption test

### 3.5.2.3 Test case information

Test Case Information			
Test Case ID	Filter FCT-002	Test Case Name	Power consumption test
References	<ul style="list-style-type: none"> <li>[17] IESCO_AMI_Project, Technical Specification PLC Filter Specification for single phase meter</li> <li>[18] IESCO_AMI_Project, Technical Specification PLC Filter Specification for three phase meters</li> </ul>		
Test Purpose	Verify power consumption of voltage circuit meets the requirements of the technical specification.		
Test Setup and Condition	<ul style="list-style-type: none"> <li>Test voltage: Un for voltage circuit;</li> </ul>		
Acceptance Criteria	The active and apparent power consumption for each voltage circuit shall not exceed 0.6W/16VA.		
Procedures	Step No.	Action	Output
	1	To connect the test equipment and the sample according to the test;	N/A
	2	Use power analyzer to measure the power consumption at the voltage circuit.	Record power consumption

### 3.6 Real Environment Simulation Test

The Real Environment Simulation Test aims to replicate the various scenarios that products may encounter during actual deployment, including network topology, communication protocols, and device interoperability. This method validates the system’s stability, performance, and impact on business operations in a real-world setting.

The test considers the following points:

**Network Topology and Deployment Scheme:** Construct a network structure based on the actual deployment plan, ensuring it closely resembles the on-site environment.

**Communication Devices and Equipment from Different Manufacturers:** Configure electricity meters and Data Concentrator Units (DCUs) from various manufacturers to ensure they can communicate and operate seamlessly. For instance, when introducing a new electricity meter, it is essential to pair it with all possible DCUs and set up the environment according to the Test Setup for comprehensive testing.

**Performance Evaluation:** Assess the impact of multiple electricity meters operating simultaneously on system business performance in the actual network environment, including metrics such as data collection success rate, stability, and data accuracy.

#### 3.6.1 PLC network performance test

The objective is to test the performance of the G3PLC solution within the environment, focus on the stability and robustness of the test.

##### 3.6.1.1 Test Suite

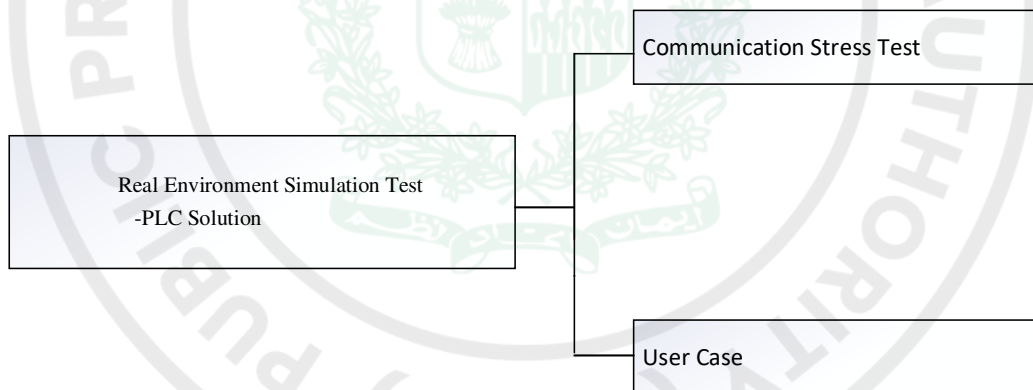

Figure 3-22 Test Suite for PLC Network Performance Test

No.	Test Group ID	Test Group Name
1	RES-PLC-CST	Communication Stress Test
2	RES-PLC-UC	User Case

Table 3-26 Test Group for PLC Network Performance Test

### 3.6.1.2 Test Setup

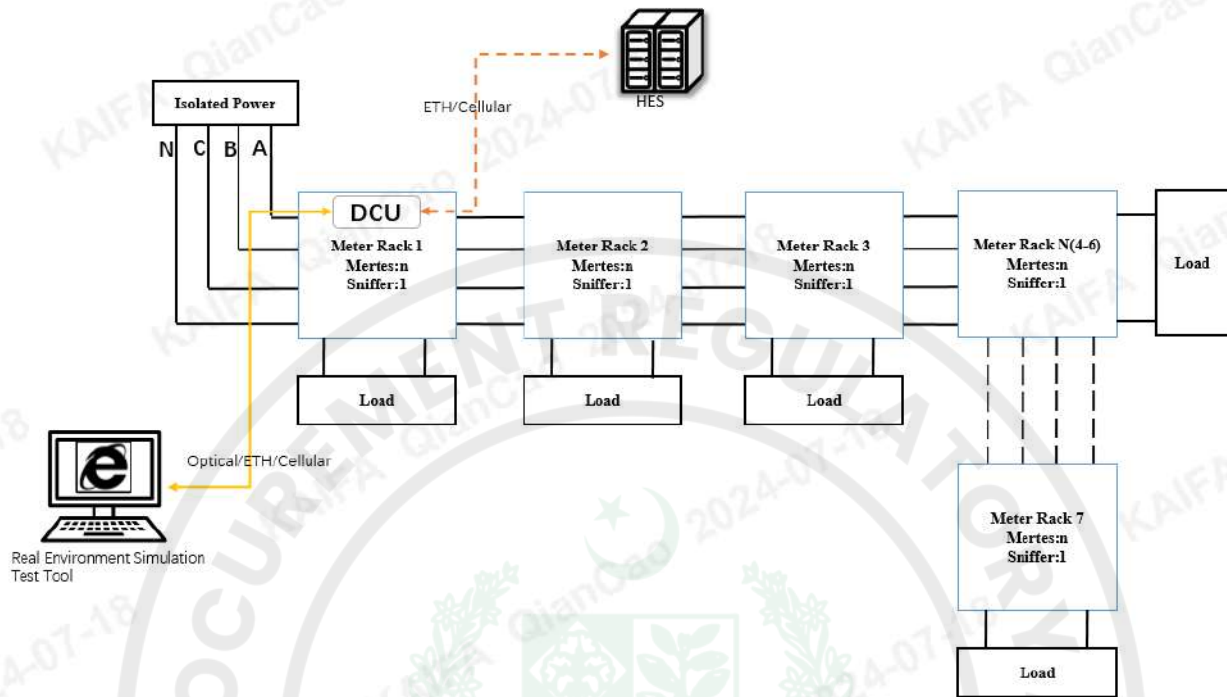

Figure 3-23 Test Setup for PLC Network Performance Test

No.	Device	Qty.	Description
1	Isolated Power	1	Isolate AC power and meter power supply, to avoid PLC signal transmission through AC power
2	Meter Rack	7	Hold on meters
3	DCU	1	It's used to build network
4	Sniffer	7	Catch the power line communication data log
5	Computer	1	It's used to run script
6	LIS Test Tool	1	Auto test software, used to schedule automated test execution
7	Load	7	Use the electric equipment for test
8	Meters	-	Each rack holds 39 meters When DUT is DCU, each rack with at least 5-10 meters from each manufacturer.
9	HES	-	Head end system

Table 3-27 Device Lists

### 3.6.1.3 Test Group Communication Stress Test

Test Group Information			
Test Group ID	RES-PLC-CST	Test Group Name	Communication Stress Test
References	• N/A		

Test Purpose	<ul style="list-style-type: none"> <li>Evaluate the solution's capabilities.</li> </ul>
Test Setup and Condition	<ul style="list-style-type: none"> <li>Figure 3-23 Test Setup for PLC Network Performance Test</li> </ul>
Test Method	<ul style="list-style-type: none"> <li>Manually control the power on and off of the equipment and start the test. After manually clicking start, the automated tool will automatically execute the test tasks and data analysis.</li> <li>The testing process is divided into two phases. The first phase is to observe the PLC networking situation, expected to last 12 hours. The second phase is to conduct cycle task (short/long communication test, read profile etc), controlling the task execution interval and frequency through automated tools, expected to last 36 hours.</li> <li>Capture the PLC communication logs during the testing process using a G3 PLC Sniffer in the environment and perform network analysis (connected meter number, offline meter number, re-register meter number etc.)</li> <li>Using automated testing tools to execute stress testing related tasks and analyze task execution efficiency (task success rate, task duration etc.)</li> </ul>
Acceptance Criteria	<ul style="list-style-type: none"> <li>ALL Case Pass</li> <li>All devices registered within 12 hours.</li> </ul>
<b>Test Case Lists</b>	
ID	Case Title
RES-PLC-CST-001	Network Analysis
RES-PLC-CST-002	Cycle Task Analysis

#### 3.6.1.4 Test Group User Case

<b>Test Group Information</b>			
Test Group ID	RES-PLC-UC	Test Group Name	User Case
References	<ul style="list-style-type: none"> <li>N/A</li> </ul>		
Test Purpose	<ul style="list-style-type: none"> <li>Execute user cases from HES in a controlled environment to evaluate the solution's capabilities.</li> </ul>		
Test Setup and Condition	<ul style="list-style-type: none"> <li>Figure 3-23 Test Setup for PLC Network Performance Test</li> </ul>		
Test Method	<ul style="list-style-type: none"> <li>Manually control the power on and off of the equipment and start the test. After manually clicking start, tester will interact with the HES to create tasks.</li> <li>The testing process is divided into two phases. The first phase is to observe the PLC meter register to HES, expected to last 12 hours. The second phase is to conduct test case.</li> <li>Cases executed in Phase2 includes: Meter Register to HES, Data Collection, On-demand Operation, firmware Update etc.</li> </ul>		
Acceptance Criteria	<ul style="list-style-type: none"> <li>All test case pass</li> </ul>		
<b>Test Case Lists</b>			
ID	Case Title		
RES-PLC-UC-001	Meter Register to HES		
RES-PLC-UC-002	Daily Billing Collect		
RES-PLC-UC-003	Monthly Billing Collect		
RES-PLC-UC-004	Load Profile Collect		
RES-PLC-UC-005	Power Quality Collect		
RES-PLC-UC-006	Meter Firmware Update		

RES-PLC-UC-007	DCU Firmware Update
RES-PLC-UC-007	On-Demand Operation from HES

### 3.6.2 Cellular network performance test

The objective is to test the performance of the Cellular solution within the environment, focus on the stability and robustness of the test.

#### 3.6.2.1 Test Suite

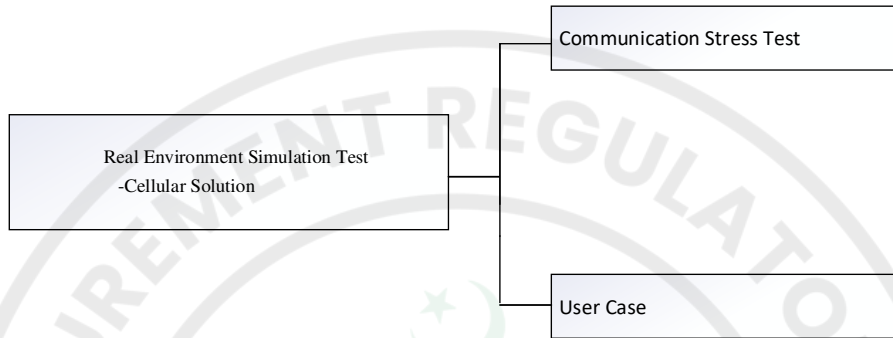

Figure 3-24 Test Suite for Cellular Network Performance Test

No.	Test Group ID	Test Group Name
1	RES-CELL-CST	Communication Stress Test
2	RES-CELL-UC	User Case

Table 3-28 Test Group List

#### 3.6.2.2 Test Setup

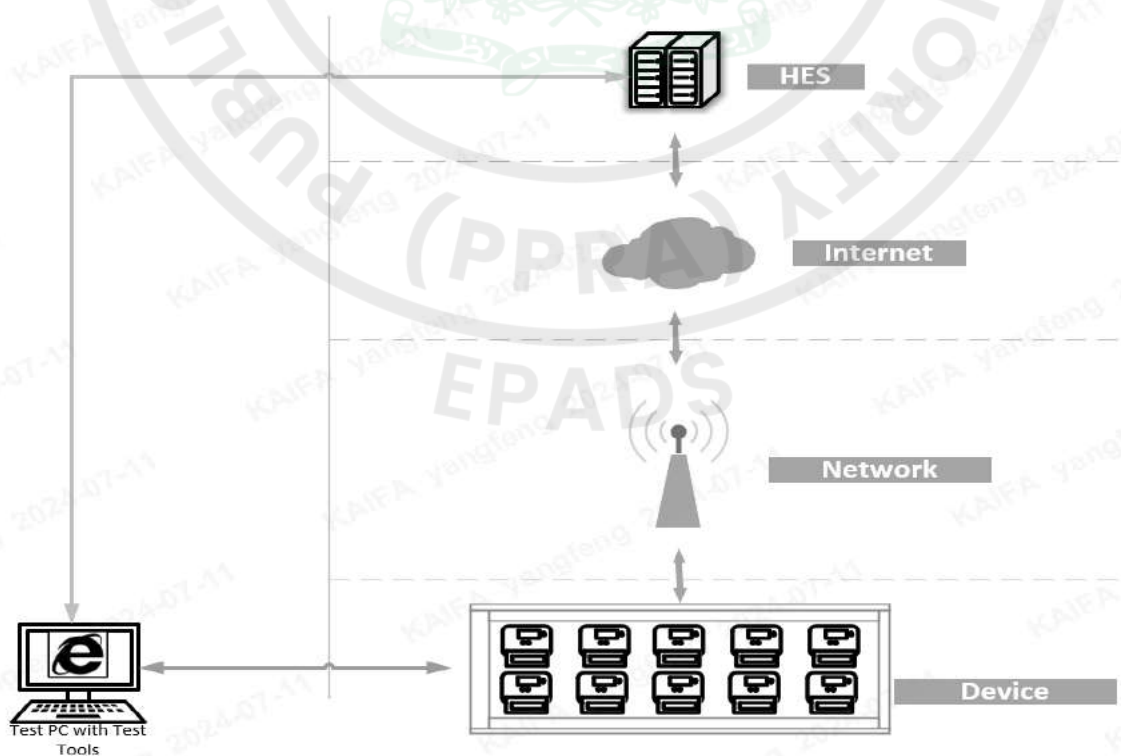
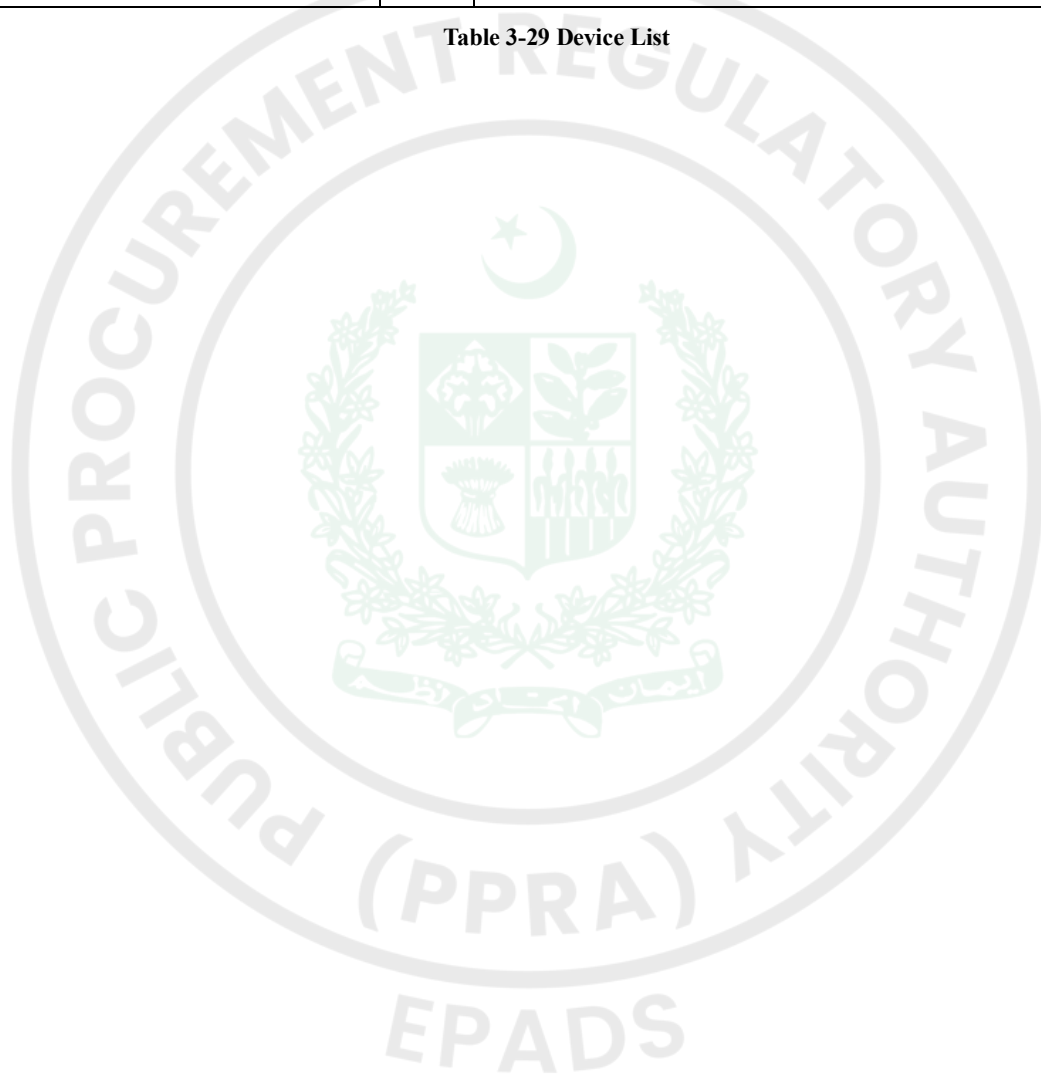

Figure 3-25 Test Setup for Cellular Network Performance Test

No.	Device	Qty.	Description
1	SIM Card	20	Used for module registration online
2	Meter Rack	1	Hold on meters
3	Test PC	1	It's used to run script
4	LIS Test Tool	1	Auto test software, used to schedule automated test execution
5	Meters	20	
6	HES	-	Head end system

**Table 3-29 Device List**



### 3.6.2.3 Test Group Communication Stress Test

Test Group Information	
Test Group ID	RES-CELL-CST      Test Group Name      Communication Stress Test
References	<ul style="list-style-type: none"> <li>N/A</li> </ul>
Test Purpose	<ul style="list-style-type: none"> <li>Evaluate the solution's capabilities.</li> </ul>
Test Setup and Condition	<ul style="list-style-type: none"> <li>Figure 3-25 Test Setup for Cellular Network Performance Test</li> </ul>
Test Method	<ul style="list-style-type: none"> <li>Manually control the power on and off of the equipment and start the test. After manually clicking start, the automated tool will automatically execute the test tasks and data analysis.</li> <li>The testing process is divided into two phases. The first phase is to observe the Cellular networking situation, expected to last 3 hours. The second phase is to conduct cycle task (short/long communication test, read profile etc.), controlling the task execution interval and frequency through automated tools, expected to last 36 hours.</li> <li>Capture the communication logs during the testing process using Wireshark in the environment and perform network analysis (connected meter number, offline meter number, re-register meter number etc.)</li> <li>Develop automated testing tools to execute stress testing related tasks and analyze task execution efficiency (task success rate, task duration etc.)</li> </ul>
Acceptance Criteria	<ul style="list-style-type: none"> <li>ALL Case Pass</li> <li>All devices registered within 3 hours.</li> </ul>
Test Case Lists	
ID	Case Title
RES-CELL-CST-001	Network Analysis
RES-CELL-CST-002	Cycle Task Analysis

### 3.6.2.4 Test Group User Case

Test Group Information	
Test Group ID	RES-CELL-UC      Test Group Name      User Case
References	<ul style="list-style-type: none"> <li>N/A</li> </ul>
Test Purpose	<ul style="list-style-type: none"> <li>Execute user cases from HES in a controlled environment to evaluate the solution's capabilities.</li> </ul>
Test Setup and Condition	<ul style="list-style-type: none"> <li>Figure 3-25 Test Setup for Cellular Network Performance Test</li> </ul>
Test Method	<ul style="list-style-type: none"> <li>Manually control the power on and off of the equipment and start the test. After manually clicking start, tester will interact with the HES to create tasks or obtain task execution results.</li> <li>The testing process is divided into two phases. The first phase is to observe the PLC meter register to HES, expected to last 12 hours. The second phase is to conduct test case.</li> <li>Cases executed in Phase2 includes: Meter Register to HES, Data Collection, On-demand Operation, firmware Update etc.</li> </ul>
Acceptance Criteria	<ul style="list-style-type: none"> <li>All test case pass</li> </ul>
Test Case Lists	
ID	Case Title
RES-CELL-UC-001	Meter Register to HES
RES-CELL-UC-002	Daily Billing Collect
RES-CELL-UC-003	Monthly Billing Collect
RES-CELL-UC-004	Load Profile Collect
RES-CELL-UC-005	Power Quality Collect
RES-CELL-UC-006	Meter Firmware Update
RES-CELL-UC-007	On-Demand Operation from HES

Title:	Interoperability Test Specification	Ver.	2.0	Page:	103 of 103
--------	-------------------------------------	------	-----	-------	------------

## 4 References

- [1] IESCO\_AMI\_Project, Technical Specification Smart Meter Companion Specification
- [2] DLMS User Association, DLMS UA 1000-1 Ed.14, 2020.
- [3] DLMS User Association, DLMS UA 1000-2 Ed.10, 2020.
- [4] IESCO\_AMI\_Project, dlms\_obis\_list
- [5] IDIS Association, IDIS INTEROPERABILITY SPECIFICATION PACKAGE 2 IP PROFILE EDITION 2.0, 2014.
- [6] 3GPP, 3GPP TS 36.521-1, 2022.
- [7] IESCO\_AMI\_Project, Technical Specification Head End System
- [8] ITU-T, “ITU-T G.9903: Narrowband orthogonal frequency division multiplexing power line communication transceivers for G3-PLC networks,” ITU, 2017.
- [9] CENELEC, “EN 50065-1: Signalling on low-voltage electrical installations in the frequency range 3 kHz to 148.5 kHz - Part 1: General requirements, frequency bands and electromagnetic disturbances,” CENELEC, 2011.
- [10] G3-PLC Alliance, G3-PLC Alliance - Performance Test Specification, V1.0 , G3-PLC Alliance, 2022.
- [11] G3-PLC Alliance, Conformance Tests Specification, V0.37 , 2023.
- [12] IESCO\_AMI\_Project, Technical Specification DCU Companion Specification
- [13] IESCO\_AMI\_Project, Technical Specification Data Concentrator Unit Specification
- [14] ADB-PDEIP II-Tranche1-AMI Project-IESCO Package-Edit.pdf.
- [15] IESCO\_AMI\_Project, OBIS LIST FOR DCU
- [16] IESCO\_AMI\_Project, CIM Specification
- [17] IESCO\_AMI\_Project, Technical Specification PLC Filter Specification for single phase meter
- [18] IESCO\_AMI\_Project, Technical Specification PLC Filter Specification for three phase meters

# Interoperability Test Lab

## 1. Test Based on IESCO AMI LAB Project

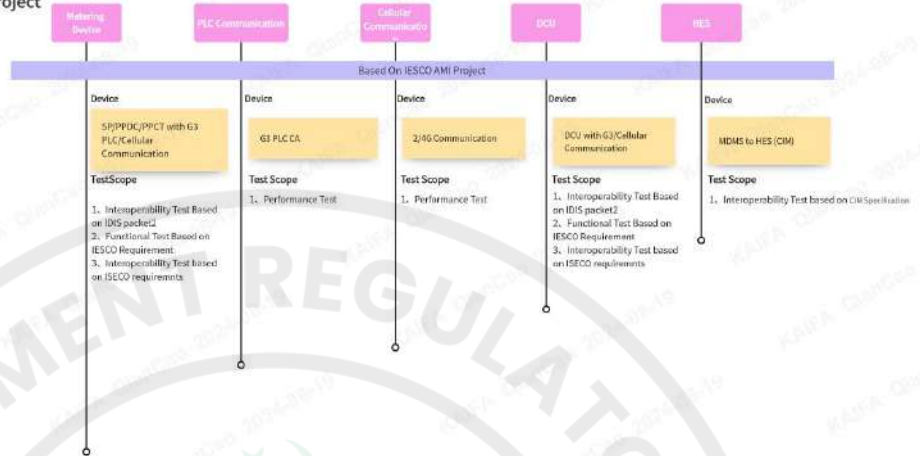

## 2. Future Expansion of Lab

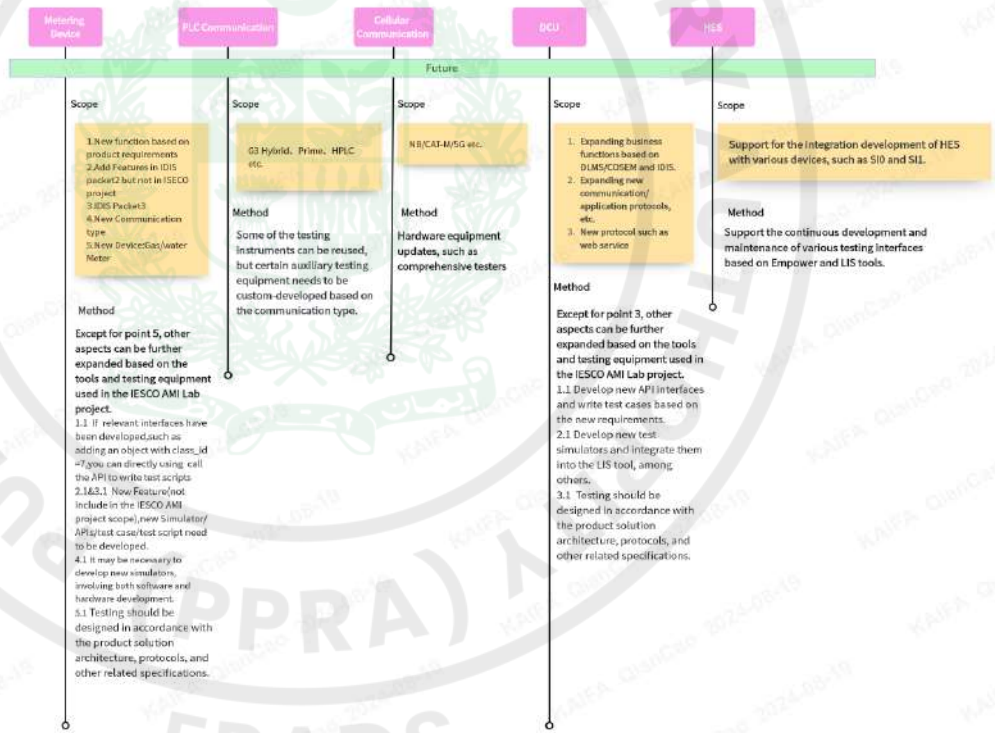

## **DECLARATION OF BENEFICIAL OWNERSHIP INFORMATION FOR PUBLIC PROCUREMENT OF CONTRACTS**

The “**Declaration of Beneficial Owners**” Information of Public Procurement Contract Awarded Regulations, 2022” require that all procuring agencies while engaging in public procurement contract worth Rs. 50 Million and above shall make a mandatory provision of beneficial ownership information of the company in the said contract as prescribed in following performa to these regulations. The procuring agencies while entering into such contracts shall publicize the beneficial ownership information of the company on PPRA’s website. The procuring agency shall forward all such contracts containing the beneficial ownership information to the Authority for placing it on PPRA’S website.

1. Name \_\_\_\_\_
2. Father’s Name / Spouse’s Name \_\_\_\_\_
3. CNIC / NICOP / Passport No. \_\_\_\_\_
4. Nationality \_\_\_\_\_
5. Residential Address \_\_\_\_\_
6. Email Address \_\_\_\_\_
7. Date on which shareholding control or  
interest acquired in the business \_\_\_\_\_
8. In case of indirect shareholding control or interest being exercised through intermediary companies, entries or other legal persons or legal arrangements in the chain of ownership or control following additional particulars to be provided:

**Stamp & Signature of Bidder**

1	2	3	4	5	6	7	8	9	10
Name	Legal form (company)/ limited liability partnership / association of persons / Single Member company / partnership firm / trust any other individual body corporate (to be specified )	Date of incorporation / registration	Name of registering authority	Business Address	Country	Email Address	Percentage of shareholding control or interest of BO in the legal person or legal arrangement	Percentage of shareholding control or interest of legal person or legal arrangement in the company	Identity of natural person who ultimately owns or controls the legal person or arrangement

9. Information about the Board of Directors (Details shall be provided regarding number of shares in the capital of the company as set opposite respective names).

**Part-II The Gazette of Pakistan Extra**

1	2	3	4	5	6	7	8
Name and Surname (in Block Letters)	CNIC No. (in case of foreigner passport No)	Father's / Husband's name in full	Current Nationality	Any other Nationality (ies)	Occupation	Residential address in full of the registered / principal office address for a subscribers other than natural person	Number of shares taken by cash subscriber (in figures and words)

10. Any other information incidental to or relevant to Beneficial owner(s)

Name and Signature  
(Person authorized to issue notice on behalf of the company)

**Stamp & Signature of Bidder**

## Bid Security Form

To: IESCO

Whereas \_\_\_\_\_ (hereinafter called "the Bidder") has submitted its Bid dated \_\_\_\_\_ for the delivery of \_\_\_\_\_ (hereinafter called "the Bid").

KNOW ALL PEOPLE by these presents that WE \_\_\_\_\_ of \_\_\_\_\_, having our registered office at \_\_\_\_\_ (hereinafter called "the Bank"), are bound unto IESCO (hereinafter called "the Procuring Agency") in the sum of \_\_\_\_\_ for which payment well and truly to be made to the said Procuring Agency, the Bank binds itself, its successors, and assigns by these presents.

Sealed with the Common Seal of the said Bank this \_\_\_\_\_ day of \_\_\_\_\_ 20 \_

THE CONDITIONS of this obligation are:

1. If the Bid
  - (a) have withdrawn or modified our Bid during the period of Bid Validity specified in the Form of Bid;
  - (b) Disagreement to arithmetical correction made to the Bid price; or
  - (c) having been notified of the acceptance of our Bid by the Procuring Agency during the period of Bid Validity, (i) failure to sign the contract if required by Procuring Agency to do so or (ii) fail or refuse to furnish the Performance Security or to comply with any other condition precedent to signing the contract specified in the Bidding Documents.
2. We undertake to pay to the Procuring Agency up to the above amount upon receipt of its first written demand, without the Procuring Agency having to substantiate its demand, provided that in its demand the Procuring Agency states the amount claimed by it is due to it, owing to the occurrence of one or both of the conditions, specifying the occurred condition or conditions.

This guarantee shall remain in force up to and including thirty-days (30) days after the period of Bid Validity, and any demand in respect thereof should reach the Bank not later than the above date.

Name:..... in the capacity of ..... signed

*[Signature of the Bank]*

**Dated on** \_\_\_\_\_ **day of** \_\_\_\_\_ **20** \_\_\_\_\_

**Power of Attorney (For signatory of Application)**

[To be printed on a PKR 100 stamp paper]

**KNOW ALL MEN BY THESE PRESENTS THAT** by this Power of Attorney ("**Power of Attorney**"),  
\_\_\_\_\_ [ *Insert name firm/Company*] having its registered office at [----  
], does hereby nominate, appoint and authorize Mr. \_\_\_\_\_, having  
CNIC No. \_\_\_\_\_ hereinafter referred to as the "**Signatory of  
Application**", to do in our name and on our behalf the following:

1. Sign and submit to \_\_\_\_\_ or its authorized nominee, the  
Prequalification Application / Bid for "-----", in response to  
the tender No. ----- Advertisement dated [---] issued by The Procuring Agency and all  
other documents and instruments required to submit the Bidding Documents.
2. execute all such contracts, deeds, documents and instruments as may be considered necessary  
and expedient in relation to the foregoing; and
3. do and carry out all other actions as may be required by the Procuring Agency in connection  
with the bidding process as a whole;
4. To immediately notify The Procuring Agency in writing of any impending or actual revocation  
as well as any change in the terms of this Power of Attorney.
5. To do in our name and on our behalf, all such acts, deeds and things necessary in connection  
with or incidental to our Bid in response to the above referred bidding document including  
signing and submission of all documents, instruments and deeds (including correcting any  
deficiencies or mistakes therein), attending any meetings organized by the Procuring Agency  
(including pre-bid conference meetings and bid opening meetings) and providing  
information/responses to the Procuring Agency in all matters in connection with our Bid.

We, [*Insert name of Firm/Company*], do hereby ratify and confirm whatsoever the Signatory of  
Application shall do by virtue of these presents and further agree that whatever the Signatory of  
Application shall do or cause to be done pursuant to this Power of Attorney shall be binding on us.  
Furthermore, each provision of this Power of Attorney is severable and distinct from the others. The  
invalidity, illegality or unenforceability of any one or more provisions of this Power of Attorney at any  
time shall not in any way affect or impair the validity, legality and enforceability of the remaining  
provisions hereof.

**IN WITNESS WHEREOF**, we have executed this **POWER OF ATTORNEY** as of [Date].

**FOR: [INSERT NAME OF APPLICANT FIRM/ COMPANY]**

Signature: \_\_\_\_\_

Name: \_\_\_\_\_

Title: \_\_\_\_\_ CNIC/Passport No. : \_\_\_\_\_

Specimen Signature of Appointing /Nominated / Authorized

i-----

ii-----

iii-----

**Stamp & Signature of Bidder**

## Bidder Information Form

Date of Bid Submission: \_\_\_\_\_

Request for Tender No.: \_\_\_\_\_

1. Bidder's Name: _____
2. In case of JV, legal name of each member: _____
3. Bidder's actual or intended country of registration: _____ _____
4. Bidder's year of registration: _____ _____
5. Bidder's Address in country of registration: _____ _____
6. Bidder's Authorized Representative Information Name: _____ CNIC No. _____ Address: _____ _____ Telephone/Fax numbers: _____ Email Address: _____

**Note:-**

The Bidder shall fill in this Form in accordance with the instructions. No alterations to its format shall be permitted and no substitutions shall be accepted

**Stamp & Signature of Bidder**

## Bidder's JV Members Information Form

Date of Bid Submission: \_\_\_\_\_

Request for Tender No.: \_\_\_\_\_

1. Bidder's Name: _____
2. Bidder's JV Member's name: _____
3. Bidder's JV Member's country of registration: _____
4. Bidder's JV Member's year of registration: _____
5. Bidder's JV Member's legal address in country of registration: _____ _____
6. Bidder's JV Member's authorized representative information Name: _____ Address: _____ _____ Telephone/Fax numbers: _____ Email Address: _____

**Note:**

1. The Bidder shall fill in this Form in accordance with the instructions
2. The above table shall be filled in for the Bidder and for each member of a Joint Venture.

**Stamp & Signature of Bidder**

## Financial Resources

Specify proposed sources of financing, such as liquid assets, unencumbered real assets, lines of credit, and other financial means, after deduction of current commitments, available to meet the total orders cash flow demands of the subject contract or contracts.

<b>Financial Resources</b>		
<b>No.</b>	<b>Source of financing along with supporting documents (must be attached)</b>	<b>Amount (Pak Rupee equivalent)</b>
1	<b>Working Capital</b>	
2	<b>Un-availed Credit Line</b>	
3	<b>Any other financial mean</b>	
4	<b>Total of Current commitment</b>	
5	<b>Net Financial Resource (1+2+3-4)</b>	

1. Latest and valid credit line facility shall be provided otherwise the same will not be considered during evaluation.
2. In case of any other financial mean, bidder is bound to provide the detail of any other financial mean otherwise the same will not be considered during evaluation.

## Financial Situation

Bidder/Supplier/JV

Financial Data for Previous 3 Years

### Information from Balance Sheet

Financial Data for Last 3 Financial Years [Pak Rupee]			
Description	2024-25	2023-24	2022-23
Total Assets			
Total Liabilities			
<b>Net Worth</b>			
Current Assets			
Current Liabilities			
<b>Working Capital</b>			

### Information from income statement

Total Revenues/ Sales			
Profit Before Taxes			
Profit After Taxes			
Interest Charges Paid			
Net Profit			

- 1) Attached are copies of financial statements (balance sheets including all related notes, and income statements) for the last three years, as indicated above, complying with the following conditions;
- All such documents reflect the financial situation of the Applicant or partner to a JV, and not sister or parent companies.
  - Historic financial statements must be audited by a certified accountant.
  - Historic financial statements must be complete, including all notes to the financial statements.
  - Historic financial statements must correspond to accounting periods already completed and audited (no statements for partial periods shall be requested or accepted).

Stamp & Signature of Bidder

## Average Annual Turnover

Each Bidder or member of a JV must fill in this form

The information supplied should be the Annual Turnover of the Bidder or each member of a JV in terms of the amounts billed to clients for each year for Contracts/Orders in progress or completed, converted to Pak Rupee at the rate of exchange at the end of the period reported.

**The information supplied should be the Annual Turnover of the Bidder or each member of a Joint Venture as per audited financial statements of last 03 Years**

Annual Turnover Data for the Last 3 Years				
Sr. No	Year	Amount Currency	Exchange Rate if applicable	Pak Rupee Equivalent
1	2024-25			
2	2023-24			
3	2022-23			
Average Annual Turnover				

Stamp & Signature of Bidder

## Manufacturer's Authorization

No. \_\_\_\_\_

Dated \_\_\_\_\_

Date of Bid Submission: \_\_\_\_\_/\_\_\_\_\_/2026  
Request for Tender No.: \_\_\_\_\_

To:

\_\_\_\_\_  
\_\_\_\_\_

WHEREAS

We \_\_\_\_\_, who are official manufacturers of \_\_\_\_\_, having factories at \_\_\_\_\_, do hereby authorize M/s \_\_\_\_\_ to submit a Bid the purpose of which is to provide the following Goods, manufactured by us \_\_\_\_\_ and to subsequently negotiate and sign the Contract.

We hereby extend our full guarantee and warranty in accordance with Clause 18 of the General Conditions of Contract, with respect to the Goods offered by the above firm.

Signed: \_\_\_\_\_

Name: \_\_\_\_\_

Title: \_\_\_\_\_

Date signed \_\_\_\_\_ day of \_\_\_\_\_ Month, \_\_\_\_\_ Year

Note:

1. The Bidder shall require the Manufacturer to fill in this Form in accordance with the instructions indicated.
2. This letter of authorization should be on the letterhead of the Manufacturer and should be signed by a person with the proper authority to sign documents that are binding on the Manufacturer.
3. The Bidder shall include it in its Bid, if so indicated in the **BDS**.

Stamp & Signature of Bidder

## Deviations from Technical Provisions

### Form DEV-1

#### DEVIATIONS FROM TECHNICAL PROVISIONS

It is presumed that the tenderer shall not take any deviation. However, if he intends to take deviations to the specified terms/specification, those must be listed in the space provided below:

Sr. No.	Clause No. / Section No.	Deviations / Clarifications

Note:- Attach additional sheets, if necessary,

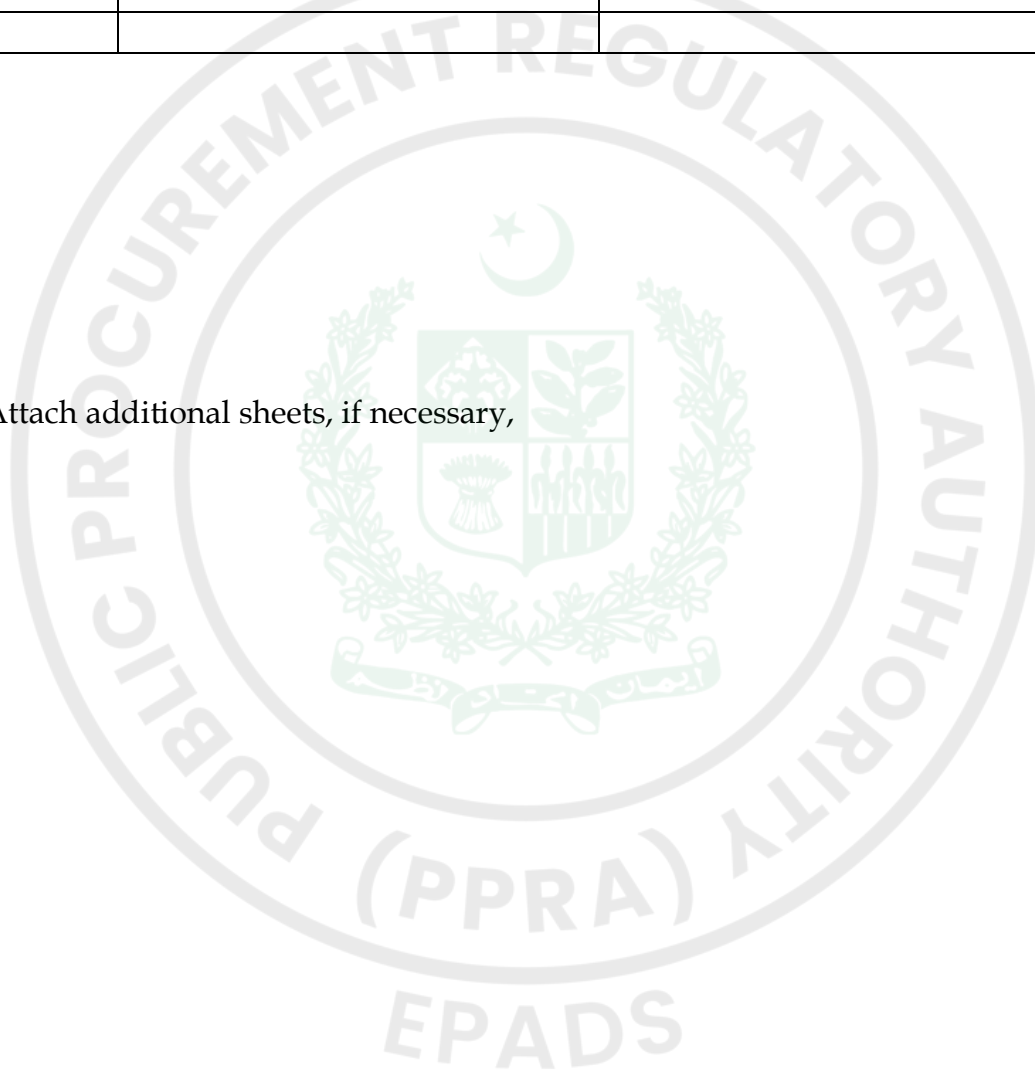

**Stamp & Signature of Bidder**

## Deviations from Contractual Condition

### Form DEV-II

#### DEVIATIONS FROM COMMERCIAL/CONTRACTUAL CONDITIONS

It is presumed that the tenderer shall not take any deviation. However, if he intends to take deviations to the specified Contractual/Commercial Conditions, those must be listed in the space provided below:

Sr. No.	Clause No. / Section No.	Deviations / Clarifications

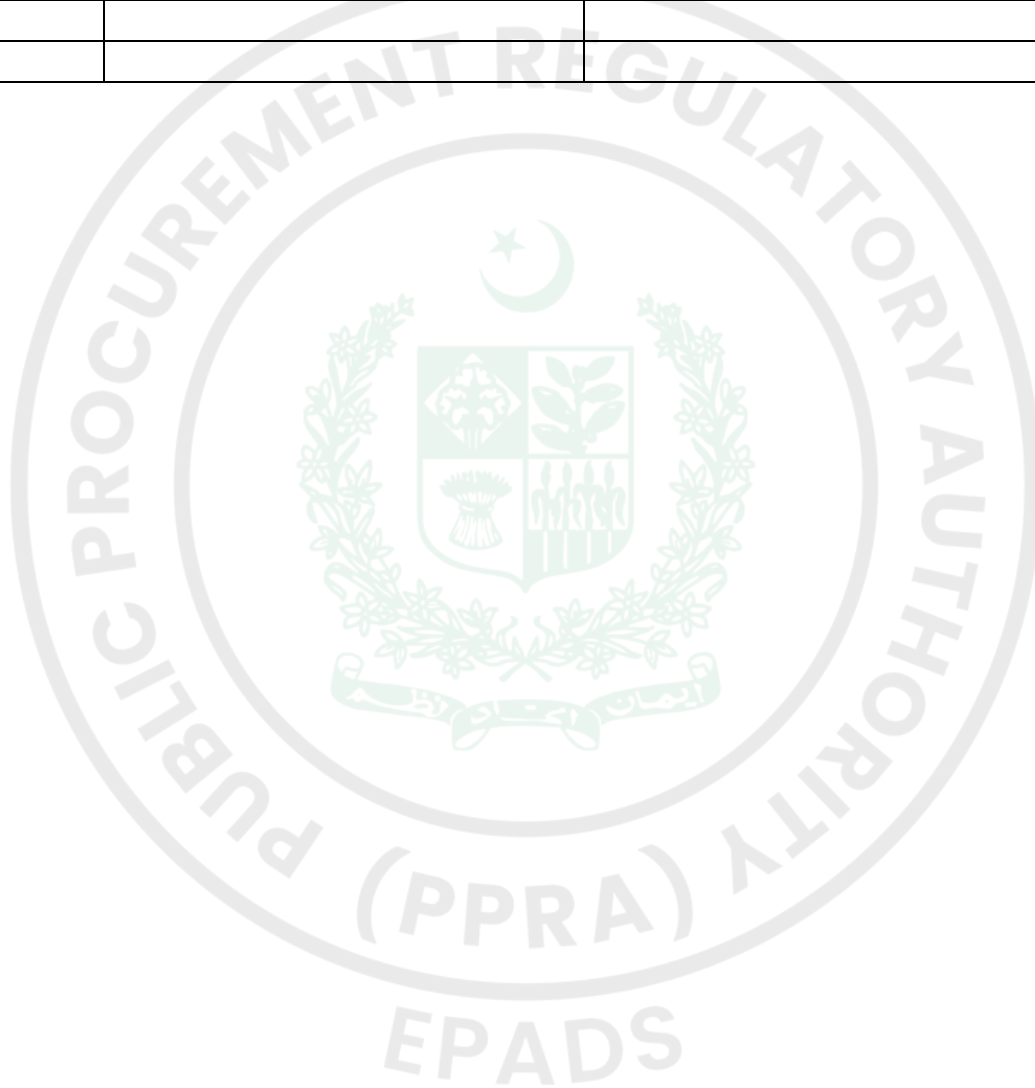

**Stamp & Signature of Bidder**

## ELIGIBLE COUNTRIES

All the bidders are allowed to participate in the subject procurement without regard to nationality, except bidders of some nationality, prohibited in accordance with policy of the Federal Government.

Following countries are eligible to participate in the procurement process:

**“All countries of world with whom Islamic Republic of Pakistan have commercial relations and for which no Trade Embargo has been imposed by the Government of Pakistan”**

Ministry of Interior, Government of Pakistan has notified List of Business-Friendly Countries (BVL), information can be accessed through following link:

<http://www.dgip.gov.pk/Files/Visa%20Categories.aspx>

<https://visa.nadra.gov.pk/business-visa-list-bvl/>

Stamp & Signature of Bidder

## Schedule of Requirements

### Part-A Delivery /Completion Period

The delivery schedule expressed as weeks/months stipulates hereafter a delivery date which is the date of delivery and delivery period will commence from the date of signing of contract agreement/issuance of Purchase Order.

“Free delivery at consignee stores, i.e. Rawalpindi, Islamabad, Rajjar & Wah”

Tender No.	Item Description	Lot #	Qty (No.)	Date of Opening	Delivery Schedule
16	Single Phase AMI Meter with GPRS (2G/4G) Communication module	I	58333	E-bids will be received till 22.07.2026 up to 10:30 A.M and will be opened at 11:00 A.M on the same date.	“19445 No. within 45 days, 19444 No. within 75 days & balance 19444 No. quantity within 105 days from the date of issuance of P.O, where bidder (local / foreign) has valid prototype approval and interoperability certificate of offered type meter” “Otherwise 50% quantity within 120 days & balance 50% quantity within 150 days from the date of issuance of P.O inclusive of interoperability and prototype testing”
		II	58333		“19445 No. within 45 days, 19444 No. within 75 days & balance 19444 No. quantity within 105 days from the date of issuance of P.O, where bidder (local / foreign) has valid prototype approval and interoperability certificate of offered type meter” “Otherwise 50% quantity within 120 days & balance 50% quantity within 150 days from the date of issuance of P.O inclusive of interoperability and prototype testing”
		III	58334		“19445 No. within 45 days, 19445 No. within 75 days & balance 19444 No. quantity within 105 days from the date of issuance of P.O, where bidder (local / foreign) has valid prototype approval and interoperability certificate of offered type meter” “Otherwise 50% quantity within 120 days & balance 50% quantity within 150 days from the date of issuance of P.O inclusive of interoperability and prototype testing”

**Note:** - Sample of each item must be provided by successful bidder. Award of tender will be subject to passing the compatibility / interoperability test and issuance of certificate.

**Stamp & Signature of Bidder**

## Terms of Reference (TOR) for Procurement of Single Phase AMI Energy Meters

The Islamabad Electric Supply Company (IESCO) intends to procure **Single Phase-2 Wire Whole Current AMI Energy Meters with GPRS communication modules** through an open competitive bidding process under PPRA rules. The meters shall comply with the technical specifications provided in the attached document and must be interoperable with IESCO's existing Advanced Metering Infrastructure (AMI) system.

The supplier shall:

- Manufacture, supply, and deliver **Single Phase AMI Energy Meters** as per the IESCO AMI technical specifications (attached).
- Ensure compatibility with IESCO's DCU and Head-End System (HES).
- Provide necessary accessories (connection sleeves, nuts, bolts, etc.). Design of sleeve, nuts and bolts are available in specification.
- Offer **warranty and after-sales support** : 2 years from the date of delivery.
- Conduct **pre-shipment testing/Fat** ( in case of foreign manufacturer) at the manufacturer's works to be witness by two (02) IESCO Engineers to be nominated by Chief Engineer (MM) IESCO at manufacturer/bidder's expense @ 250 USD dollar per day for foreign inspection and provide test reports as specified in Specification. Bidder will arrange FAT and bear all charges of testing arrangement and other related expenses in case of foreign or local inspection. In case meter manufactured locally than FAT will be local and if manufactured abroad, FAT will be abroad. In case of Local manufacturer, Inspection of the material will be carried out at manufacturer's works by Chief Engineer (MI) PPMC Lahore or his authorized representative(s) jointly with rep of IESCO. Notice in writing shall have to be given to Chief Engineer (MI) PPMC Lahore and IESCO (simultaneously) by you when the store against the order is ready for inspection. All reasonable facilities as provided in the specifications or followed by the Industry or Trade in General shall also have to be afforded to the Inspecting Officer/s by you at your expenses for carrying out Inspection. You will have to deposit 0.5% of the cost of the material along with the inspection call to the Chief Engineer (MI) PPMC Lahore.

**Stamp & Signature of Bidder**

- Prior to the award of the contract, successful bidder shall submit thirty (30) samples in case of PLC communication and 6 samples in case of GPRS communication or as per technical requirement, of the proposed electricity meter for the purpose of interoperability testing with IESCO's Advanced Metering Infrastructure (AMI) system. Upon contract signing or prior to it, the successful bidder shall pay interoperability-testing charges at the rate of PKR 500 (Pakistani Rupees five hundred) per single phase meter, applicable to the entire order quantity, in case of interoperability test conducted in IESCO Own Lab (if operational). In case of interoperability test to be conducted by external lab the successful bidder will get the test conducted directly through the external lab as per IESCO AMI's system requirements on his own expenses. Following successful completion of the interoperability tests, office of the PD (AMI) shall issue a Compatibility Certificate, confirming the meter's interoperability with IESCO's AMI system. This certificate may be utilized by the bidder for future procurements, subject to the validity period specified in the certificate. The scope of interoperability testing at this stage shall be limited to verifying communication compatibility between the meter and the Data Concentrator Unit (DCU) (for PLC meters only) and Head-End System (HES).
- Mechanical, environmental, and other performance-related tests are not included at this stage and shall instead be conducted during the Factory Acceptance Test (FAT), Pre-Shipment Inspection, and/or Type Testing stage(s), as applicable
- In case of testing conducted at IESCO Own lab (if operational), during testing if sample submitted for testing is failed to qualify the interoperability test, then bidder required to upgrade firmware and bidder will pay PKR 3 million for firmware upgradation charges for the next sample. If the Interoperability test fails second time, firm will be considered Non-Responsive and bid/performance security will be fortified / encashed in favour of IESCO and the LOI/ Contract Agreement shall stand cancelled. Any further delay shall be on account of the Supplier / manufacturer and IESCO reserves the right to deduct the Liquidated Damages according to the relevant clause of the bidding documents/LOI/Purchase Order.

**Stamp & Signature of Bidder**

- The meter design should fulfil all functional requirements of Employer related to system interoperability and functions demanded. However, mechanical design can vary from provided specifications and if bidder has a different mechanical design available which fulfills functional and interoperability requirements as per specification, the same will be considered for evaluation. Please review the table of requirements attached and it is informed that fulfilling mandatory requirements is necessary. However, alternates can be provided for desirable requirements as explained.
- Conduct Prototype/ type testing through the office of CE/GM (TSW) IESCO, from a lab having standards as mentioned in specification and complete tests as per type test listed in specification which is attached with bid document. In case the offered meter is already having valid type testing, the report will be attached at time of bid submission otherwise bidder will provide undertaking to carry out fresh prototype testing without effecting the delivery period on bidder cost and arrangement to be duly witnessed by Two (02) IESCO engineers. Prototype approval can also be obtained from concerned directorate of PPMC or any other acceptable national or international IEC/IEEE registered lab. If bidder does not have a valid prototype approval, the same can be done after bid process without affecting the delivery schedule. If prototype is done by anyone other than PPMC, PPMC will not carry out witnessing of this proto-type testing and IESCO representatives will be nominated to witness and verify the same.
- Ensure interoperability of meter with Employer's mobile app as per IEC 62056-21.
- DLMS certification of meter model proposed to be supplied to Employer from DLMS UA. The supplied meters should also have DLMS certification license.
- Ensuring acceptance and incorporation of firmware upgrades as per Employer's requirement in future.
- Successful bidder will provide shipment file for meters to be supplied as per format provided in specification separately from routine file provided by manufacturers normally for procurement of meters. The shipment file shall be provided at least 15 days before delivery of meters.

**Stamp & Signature of Bidder**

- CIM specifications and companion specifications as per compatibility with IESCO system is attached with bid document. Bidders must follow the same to ensure interoperability with AMI system of IESCO.

## Technical Specifications

### Part-B Technical Specifications

The material must be as per IESCO AMI Specifications (Amended to date) attached.

Successful bidder will provide shipment file for meters to be supplied as per format provided in specification separately from routine file provided by manufacturers normally for procurement of meters. The shipment file shall be provided at least 15 days before delivery of meters.

Companion specifications as per compatibility with IESCO system is attached with bid document. Bidders must follow the same to ensure interoperability with AMI system of IESCO.

Successful bidder will provide samples for interoperability / compatibility tests and award of contract will be subject to issuance of certificate by Employer.

The meters must comply with the following key requirements:

#### General Requirements

**Type:** Single-phase, 2-wire, whole current, bi-directional.

**Nominal Voltage:** 230V, 50Hz.

**Current Range:** 5(40)A.

**Accuracy:** Class 1 for active energy, Class 2 for reactive energy.

**Communication:** Support **GPRS (2G/4G)** (as per tender inquiry).

**Display:** 8-digit (minimum) LCD with auto, manual scroll and power down modes.

Stamp & Signature of Bidder

**Protection:** IP54-rated (suitable for outdoor use), tamper-proof, anti-magnetic interference.

**Lifespan:** ≥15 years.

### **Functional Requirements**

**Measurement:** Active/Reactive energy, maximum demand, power factor.

**Tariff Management:** Support 4 tariffs, 24 time-of-use (TOU) slots.

**Load Profiles:** Energy, daily, Monthly and power quality load profiles.

**Anti-Tampering:** Detection of meter/terminal cover removal, magnetic tampering, DC injection, etc.

**Remote Control:** Relay for disconnection/reconnection via HES.

**Prepayment/Post payment Mode:** Configurable via HES.

**Compatibility with mobile app of Employer.**

**Other requirements as per IESCO AMI Specification.**

### **Communication & Security**

**Interfaces:** Optical port (IEC 62056-21), 4G/2G, or GPRS (2G/4G).

**Protocols:** DLMS/COSEM, TCP/IP, HDLC.

**Security:** AES-128 encryption, HLS (High-Level Security), role-based access control.

**Stamp & Signature of Bidder**

## **DRAWINGS/BROCHURE**

**Relevant documents / brochures of material showing the technical parameters / specification / make / origin / any other specific information are part of Tender Specification /Technical Requirement**

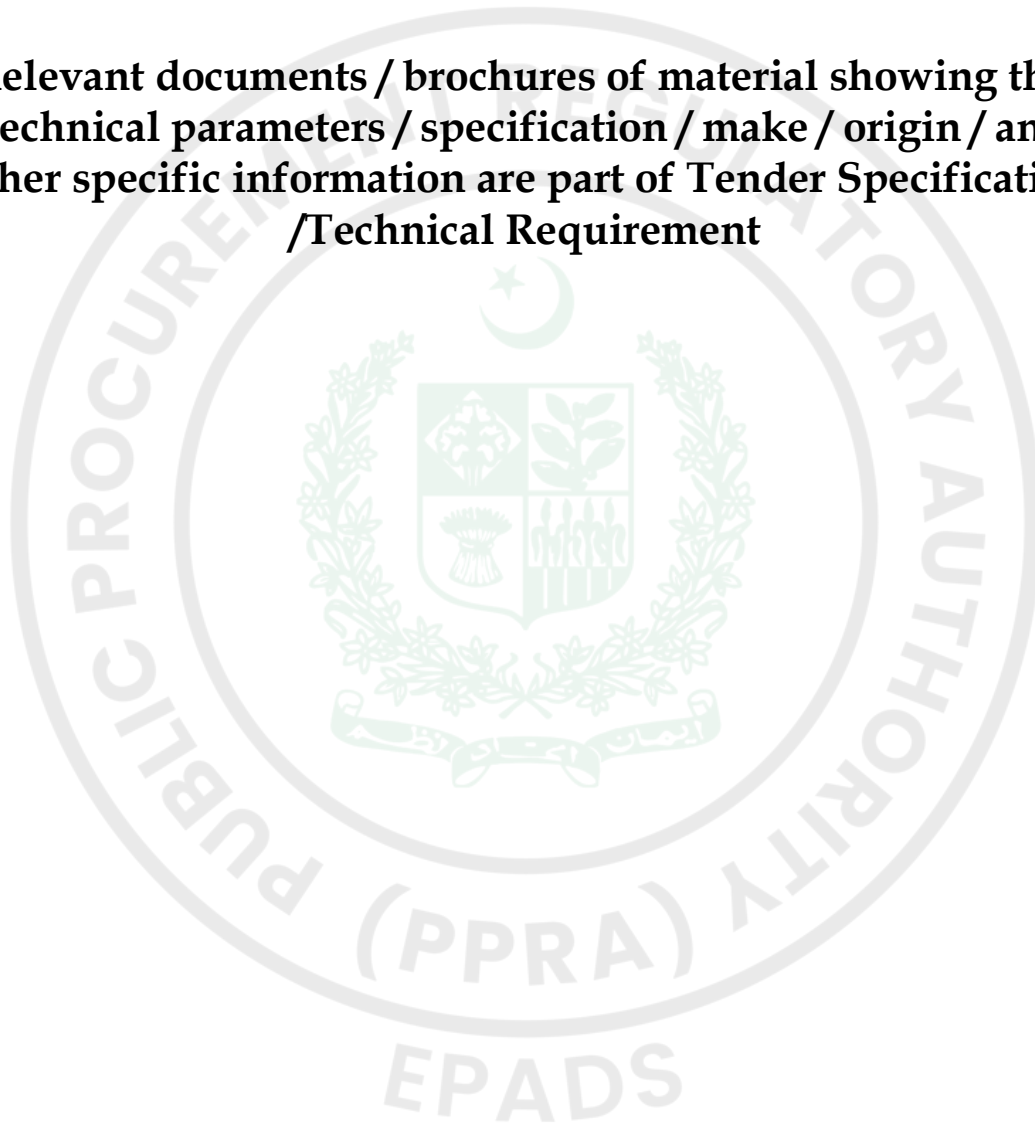

**Stamp & Signature of Bidder**

# Table of Requirements

Single Phase Whole Current Active/Reactive Smart Energy Meter

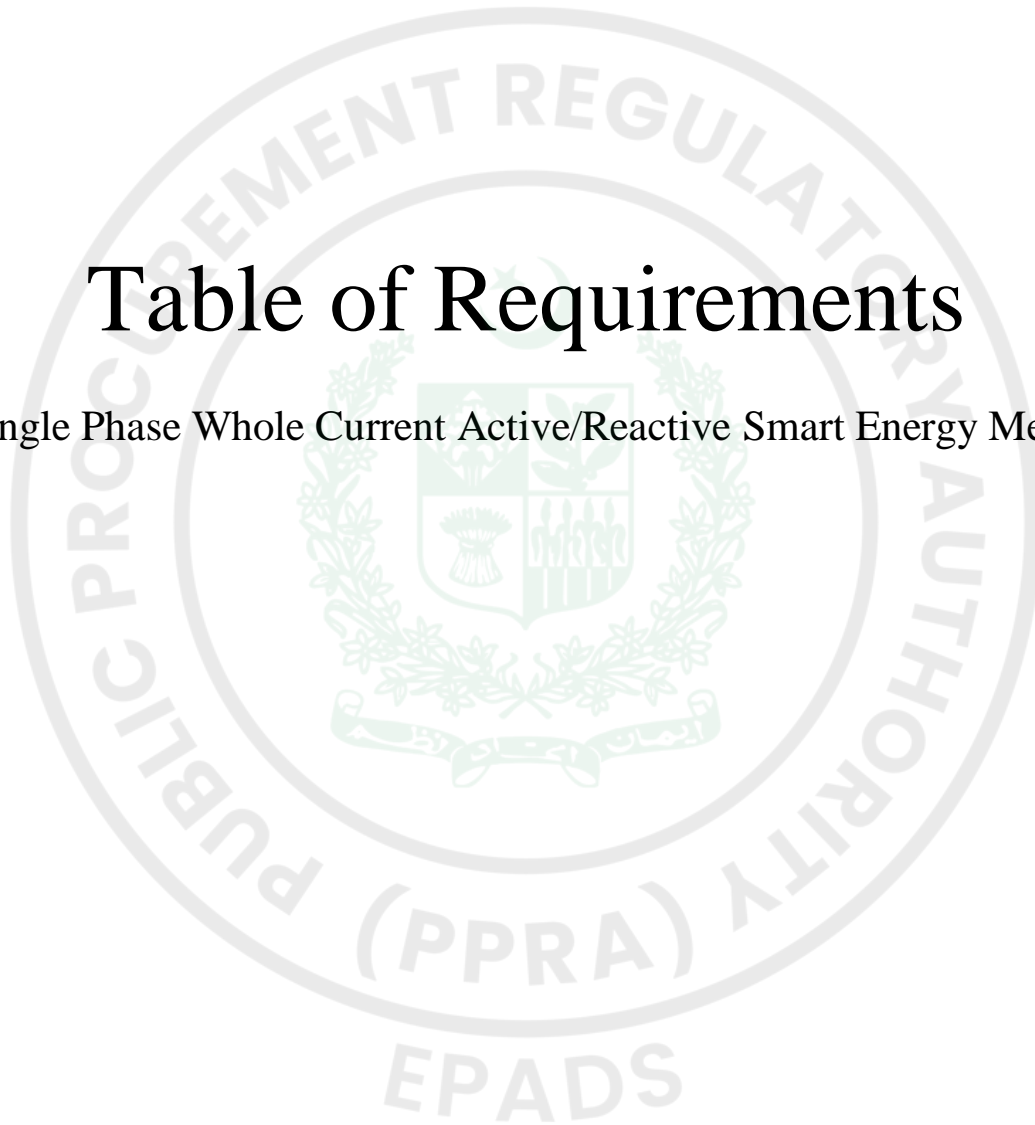

**Stamp & Signature of Bidder**

This document differentiates mandatory and desirable requirements for meter. Please read this document in conjunction with AMI specification and Companion specification provided.

### Main Technical Features

Technical features	Description	Remarks	Bidders Description
Connection type	Single-phase two-wire(1P2W), direct connection, Bi-directional measurement	Mandatory requirement	
Measurement accuracy	Active power: Class 1 Reactive power: Class 2	Mandatory requirement. However, better than required is also acceptable.	
Nominal voltage (Un)	230 V	Mandatory requirement	
Specified operating voltage range	0.7Un ~ 1.2Un	Mandatory requirement	
Extended operating voltage range	0.6Un~1.2Un	Mandatory requirement	
Limit operating voltage range	0.4 Un*~1.2Un	Mandatory requirement	
Voltage failure bridging time	0.5 Seconds	Mandatory requirement	
Voltage restoration function standby after	5 Seconds	Mandatory requirement	
Current range	5(40) A, In=5A, I <sub>max</sub> =40A	In could be 5/10 A, I <sub>max</sub> =40 A or above	
Starting current	0.004 Ib for Active 0.005Ib for Reactive	Mandatory requirement	
Frequency	50 Hz (± 2%)	Mandatory requirement	
Meter constant	2000 imp. / kWh(kvarh)	Desirable. Bidder can propose any alternate meeting DDS, IEC and other international standards.	
Calibration interval	Meter life-time (15 years)	Mandatory requirement	

Stamp & Signature of Bidder

Technical features	Description	Remarks	Bidders Description
Power consumption	Voltage circuit: $\leq 2 \text{ W} / 5 \text{ VA}$ for base meter without a module Current circuit: $\leq 4 \text{ VA}$ per phase	Mandatory requirement	
Short time over current	30 I <sub>max</sub> according to IEC for 0.01 sec	Mandatory requirement	
Withstand voltage	440V (max. 6 hours)	Mandatory requirement	
Display type	Segment type LCD, 8 digits, Digit height: 9mm	8 digits mandatory	
Energy LED	One LED for active energy, one for reactive energy	Mandatory requirement	
Status LED	Refer to LED indicators chapter for the communication status indication.	Mandatory requirement	
Display button	Touch type button	Mandatory requirement with suitable type of button. If bidder can provide any alternate ensuring IP-54 outdoor compliance, the same will be acceptable.)	
Communication interfaces	IR: Service Interface, Infrared optical interface, 9600bps 4G/2G communication module or GPRS (2G/4G) communication module, replaceable communication module	Mandatory requirement	

Stamp & Signature of Bidder

Technical features	Description	Remarks	Bidders Description
Relay	Contact Rating: 40A 230Va.c Maximum switching power: 15kVA Maximum switching current: 60A Maximum switching voltage: 276Va.c Maximum overload current: 100A (up to 15minutes ) Electrical endurance: 10,000 ops	Mandatory requirement	
RTC	IEC 62054-21( $\leq \pm 0.5$ sec/ day, 230Vac, 23°C)	Mandatory requirement	
Electrostatic discharge	Contact discharge 8kV Air discharge 15kV Current and voltage circuits 4kV Auxiliary circuits >40V 2KV Events to be recorded as well	Mandatory requirement	
Fast transient burst	4kV	Mandatory requirement	
Surge immunity	4kV	Mandatory requirement	
Electromagnetic RF fields	Frequency range 80MHz to 2000MHz With current 10V/m Without current 30V/m	Mandatory requirement	
Conducted disturbance	Frequency range 150kHz to 80MHz Voltage level 10V	Mandatory requirement	
Radio interference (peak value)	30MHz-1GHz : 30 to 230 MHz <30 dB( $\mu$ V) 230 to 1 000 MHz <37 dB( $\mu$ V)	Mandatory requirement	
AC voltage	4kV: 50Hz for one minute	Mandatory requirement	
Impulse voltage	8kV: 1.2/50 $\mu$ s	Mandatory requirement	

Stamp & Signature of Bidder

Technical features	Description	Remarks	Bidders Description
Clearance(Min)	3.5mm(HLV to HLV)/ 5.5mm(HLV to SELV)	Desirable	
Creepage(Min)	6.50mm(HLV to HLV)/ 10mm(HLV to SELV)	Desirable	
Insulation resistance	≥5 MΩ	Mandatory requirement	
Reference temperature	23°C	Mandatory requirement	
Operating temperature range	-25°C ~ +70°C	Mandatory requirement	
Limit operating temperature range	-25°C ~ +80°C	Mandatory requirement	
Temperature range for storage and transport	-25°C ~ +80°C	Mandatory requirement	
Relative Humidity	Up to 95%	Mandatory requirement	
Altitude	Up to 1000 meter above sea level.	Mandatory requirement	
Data retention	≥ 15 years	Mandatory requirement	
Lifetime	≥ 15 years	Mandatory requirement	
Backup power supply	Internal battery, external battery slot	Mandatory requirement	
Payment mode	Support post-payment and prepayment mode	Mandatory requirement	
Protection class acc.	Class II	Mandatory requirement	
Repeater function	Meter should act like a repeater for nearby other meters	Mandatory requirement in case of PLC meter procurement	

Stamp & Signature of Bidder

## Mechanical Design

Mechanical design is flexible and IESCO will accept any other mechanical design fulfilling DDS, IEC or any International standard fulfilling IESCO requirements. Any function defined in provided specifications should not be missing.

### Mechanical and other Features

Mechanical and other features	Description	Remarks	Bidders Description
Ingress Protection	IP 54 outdoor use	Mandatory requirement	
Mounting	A Base triangle	Desirable. Bidder can propose other mounting arrangement also meeting DDS, IEC or other international standards.	
Meter Cover	UV-resistance, high impact-resistance and self-extinguishing polycarbonate (PC+10% GF)	Mandatory requirement	
Meter cover color	Grey	Desirable. Bidder can propose other also meeting DDS, IEC or other international standards.	
Terminals	brass with tin plated ( $\geq 5$ micron) and provide two Zinc-Nickel alloy plated ( $\geq 5$ micron) carbon steel M5 screws in each current terminal which are better protected against corrosion. The screw is at least 3 threads in the terminals. The screw head type is Philips and slotted.	Desirable. Bidder can propose alternate as per IEC, DDS or international standards	
Terminal diameter	7.2 $\pm$ 0.2mm	Mandatory (detailed description available in specifications) if using barrel type terminal design.	

Stamp & Signature of Bidder

Mechanical and other features	Description	Remarks	Bidders Description
Terminal cover	<p>The terminal cover is made of UV-resistance, high impact-resistance and self-extinguishing polycarbonate (PC+10% GF) and suitable for cables incoming and outgoing vertically from the bottom, and have provision for security sealing.</p> <p>The connection diagram of the meters is shown on the terminal cover. The thickness of terminal cover is 2.5mm(±5%).</p>	Mandatory requirement	

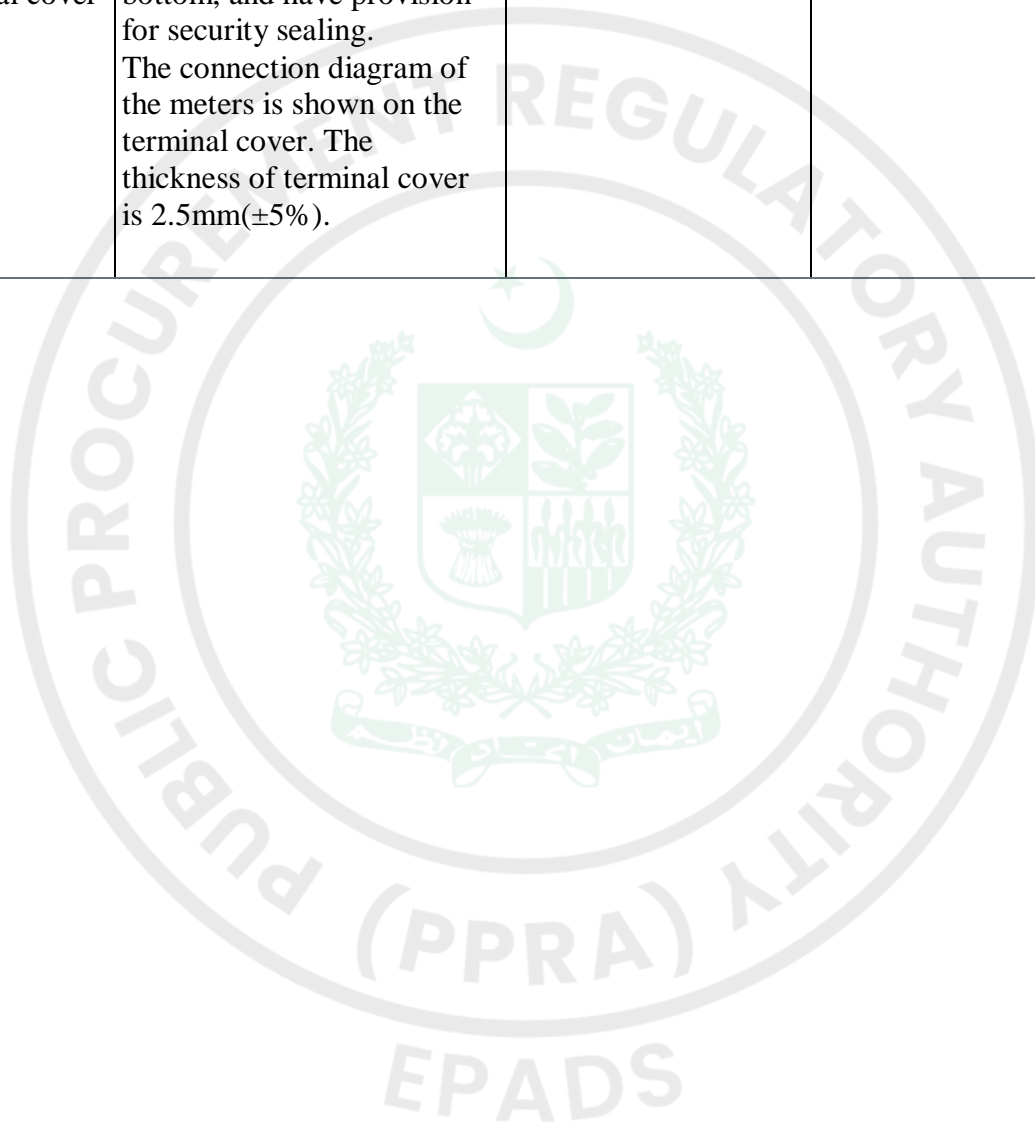

**Stamp & Signature of Bidder**

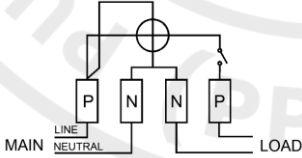
Mechanical and other features	Description	Remarks	Bidders Description
Display Button	The meter is equipped with one touch button for scrolling display.	Button is mandatory with type suitable for IP 54 outdoor	
External Battery slot	The meter supports an external battery slot for CR2032 type, which is protected by the terminal cover.	Mandatory requirement. However, battery type can be proposed by bidder which should be common market item.	
Dimensions and weight	The dimension of meter is L×W×H , the weight of meter is ≤1Kg	Desirable. Bidder can propose alternate as per IEC, DDS or international standards	
Name plate	Completely defined in specification document	Mandatory requirement	
Meter Serial number	Method of allocating serial number defined in specification document	Mandatory requirement. Successful bidder will get list of already allocated meter numbers from IESCO and will issue new meter numbers different from existing ones.	
Wiring diagram	 <p>The diagram shows a meter with four terminals: P, N, N, and P. The first P terminal is connected to the MAIN LINE. The first N terminal is connected to the NEUTRAL. The second N terminal is connected to the second P terminal. The second P terminal is connected to the LOAD.</p>	Mandatory requirement	
Sealing of meter	Five security seals defined in specification document	Desirable. Bidder can propose alternate as per IEC, DDS or international standards	

Stamp & Signature of Bidder

<b>Mechanical and other features</b>	<b>Description</b>	<b>Remarks</b>	<b>Bidders Description</b>
Meter functions	Energy measurement, maximum demand measurement, cumulative maximum demand measurement and instantaneous parameters measurements are defined in specification document	Mandatory requirement. All functions should be available.	
Real time clock	Details available in specification document	Mandatory requirement	
Backup power supply	Required features defined in specification document	Mandatory requirement	
Tariff	Tariff structure defined in specification document	Mandatory requirement	
Monthly Billing	Parameters and method of generating billing profile defined in specification document	Mandatory requirement	
LED indicators	Three LED indicators as defined in specification document	Mandatory requirement	
LCD Display	Items to be displayed on LCD are defined in specification document	Desirable. Bidder can propose alternate as per IEC, DDS or international standards	
Display mode	Auto, manual and power down modes are defined in specification document	Mandatory requirement	
Disconnection reasons and display messages	Details defined in specification document	Desirable. Bidder can propose alternate as per IEC, DDS or international standards. However, no function should be missing.	
Payment mode	Prepayment and post payment mode as per details in specification document	Mandatory requirement	

**Stamp & Signature of Bidder**

<b>Mechanical and other features</b>	<b>Description</b>	<b>Remarks</b>	<b>Bidders Description</b>
Load profile status word	Defined in specification document	Mandatory requirement	
Energy load profile	Configurable range: 5/10/15/30/60 minutes (Default 60 minutes). 5760(60 minutes, 240 days). Configurable for including or excluding any parameter.	Mandatory requirement	
Daily load profile	Configurable range: every 24 hours at 00:00 31(24 hours, 31 days) Configurable for including or excluding any parameter.	Mandatory requirement	
Power quality load profile	Configurable range: 5/10/15/30/60 minutes (Default 60 minutes) 5760(60 minutes, 240 days) Configurable for including or excluding any parameter.	Mandatory requirement	
Monthly profile	As per specification document	Mandatory requirement	
Relay control	As per specification document	Mandatory requirement	
Power limitation	As per specification document	Mandatory requirement	
Over current	As per specification document	Mandatory requirement	
Demand side management	As per specification document	Mandatory requirement	
Export energy function	As per specification document	Mandatory requirement	
Anti-tamper	As per specification document	Mandatory requirement	
DC immunity	As per specification document	Mandatory requirement	

**Stamp & Signature of Bidder**

<b>Mechanical and other features</b>	<b>Description</b>	<b>Remarks</b>	<b>Bidders Description</b>
Self-diagnostics and meter status word	As per specification document	Mandatory requirement	
Instantaneous status word	As per specification document	Mandatory requirement	
Tamper status word	As per specification document	Mandatory requirement	
Firmware upgrade	As per specification document	Mandatory requirement	
Event logs	As per specification document	Mandatory requirement and meter should be configured in exactly same way	
Communication interface	As per specification document	Mandatory requirement	
Optical port communication	As per specification document	Mandatory requirement	
Remote communication	As per specification document	Mandatory requirement	
Security	As per specification document	Mandatory requirement	
Keys	As per specification document	Mandatory requirement	
Display item list	As per specification document	Mandatory requirement. Parameters defined in auto, manual and power down mode should be same as in specification and should be configurable.	

**Stamp & Signature of Bidder**

<b>Mechanical and other features</b>	<b>Description</b>	<b>Remarks</b>	<b>Bidders Description</b>
Communication module	As per specification document	Mandatory requirement. Mechanical design can change.	
Companion specification	As per specification document	Mandatory requirement	
OBIS codes	As per specification document	Mandatory requirement	
Meter default configurations for event push or pull, displays etc.	As per specification document	Mandatory requirement	

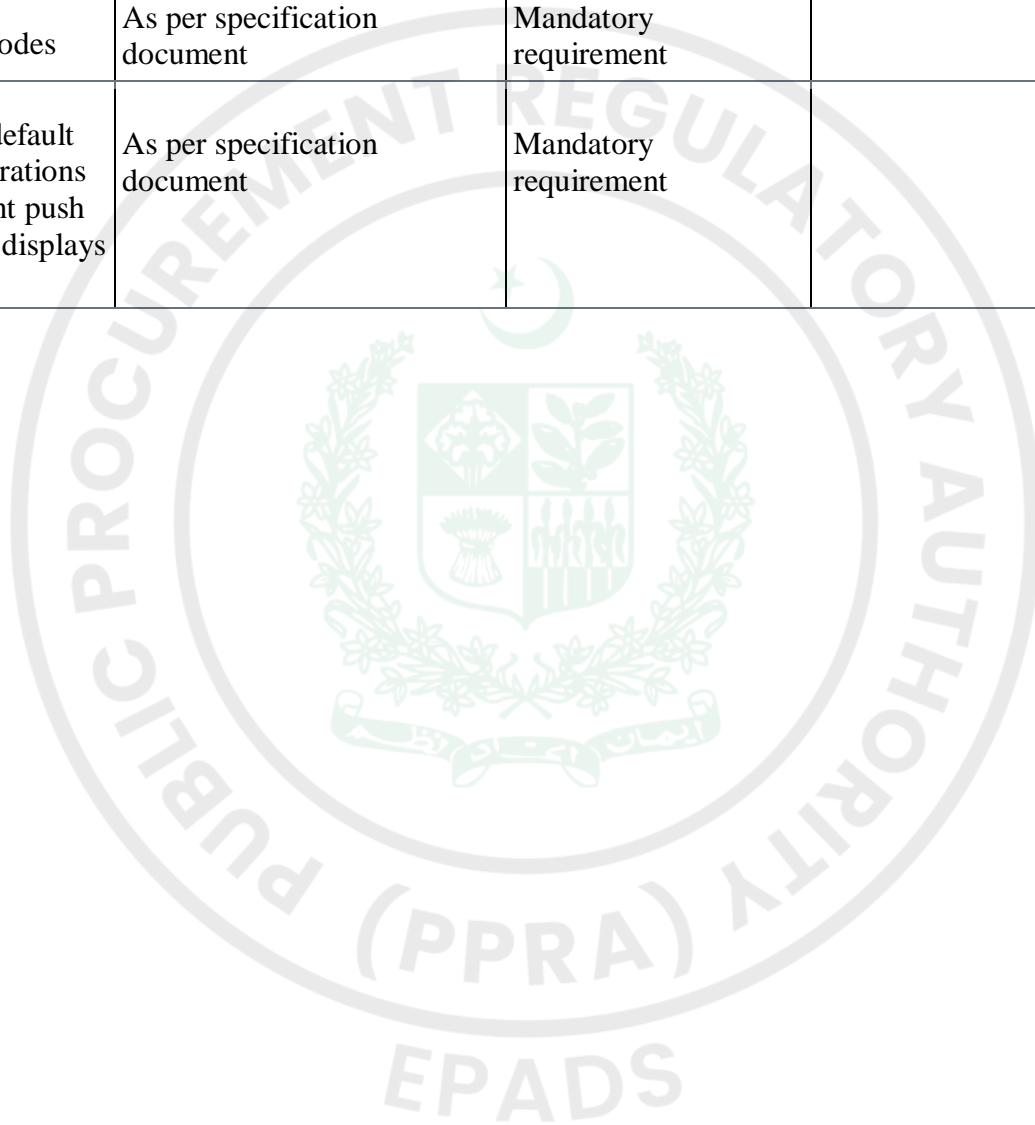

**Stamp & Signature of Bidder**

## Special Conditions of Contract (SCC)

The following Special Conditions of Contract (SCC) shall supplement the GCC. Whenever there is a conflict, the provisions herein shall prevail over those in the GCC. The corresponding clause number of the GCC is indicated in parentheses.

SCC Clause Number	GCC Clause Number	Amendments of, and Supplements to, Clauses in the GCC
<b>Performance Security ( or guarantee) (GCC 23)</b>		
1.	23.1	The amount of performance security (or guarantee), as a percentage of the Purchase Order Price, shall be ten (10%) percent of the Contract Price in favor of CEO IESCO from Schedule Bank of Pakistan having rating A+ in shape of Bank Guarantee. Contractor will provide performance Guarantee at time of acceptance of Notification of Award/Letter of Intent.
2.	23.2	The Procuring Agency will have the right to forfeit the Security Bond / Bank Guarantee (Performance Bond):- (A) If the contractor: i) Fails to supply the goods within the time specified. ii) Commits any breach of contract. iii) Fails to account for the Import License issued on account of the purchaser. iv) Fails to account for the raw material secured by the contractor against any License or permit issued on account of the PA v) Fails to return drawings, design or any material belonging to the PA, which was to be returned in good condition to the Contracting Officer after the successful termination of the contract. (B) For other reasons specified in the Purchase Order by the PA for forfeiting the security deposit. If the forfeiture of the security deposit does not compensate the contracting officer for losses suffered due to non-delivery or breach of contract or for any other reasons, the PA will have a right to forfeit other security deposits or to recover the same from any other security deposit made in favor of any other unit of DISCOs/GENCOs/NTDC/WAPDA/IESCO or from any money due to the Contractor from any unit of DISCOs/GENCOs/NTDC/WAPDA/IESCO.
3.	23.4	After delivery and acceptance of the Goods, 100% percent of the Performance Security (or guarantee) shall be withheld to cover the Supplier's warranty obligations in accordance with GCC Clause 34.1.
<b>Payment (GCC Clause 31,32&amp;33)</b>		
4.	-	The method and conditions of payment to be made to the Supplier under this Contract shall be as follows: <b>Payment for Goods supplied :</b> 100% payment will be made by the Finance Director IESCO Islamabad, out of budget head _____ on production of following documents after necessary pre-audit: i. Bill in triplicate duly signed and stamped mentioning clearly NTN No. & GST No. ii. Delivery Challan and GRN duly stamped and signed by the consignee (in original) iii. Warranty certificate iv. Inspection certificate issued by the Chief Engineer (Material Inspection) PPMC, Lahore or his authorized representative or by IESCO not below the rank of Dy. Director (Inspection).  v. Certificate issued by the Chief Engineer (MM), IESCO Islamabad regarding acceptance of Performance Bond vi. Certificate from Excise & Taxation Department, certifying the fact that all payable professional taxes have been paid by the supplier. vii. General Sales Tax Invoice. viii. Custom clearance certificate (if material is purchased from abroad) ix. Certificate issued from consignee store Manager that material received vides GRN No. _____ dated _____ has been taken on stock against stock code No. _____ <p style="text-align: center;">OR</p> Finance Director IESCO will establish a confirmed and irrevocable Letter of Credit for Rs. _____/- through any nationalized bank of Pakistan in your favour. All charges relating to opening of <u>Letter of Credit</u> and negotiation thereon, shall be borne by you. The amount of material excluding General Sales Tax i.e. Rs. _____/- in the Letter of Credit shall be available for negotiation and en-cashable on submission of following documents:-

		<p>i) Bill in triplicate mentioning clearly NTN No. &amp; GST No.</p> <p>ii) Delivery Challan and GRN duly stamped and signed by the consignee</p> <p>iii) Warranty certificate</p> <p>iv) Inspection certificate issued by the Chief Engineer (MI) PPMC, Lahore or his authorized representative or by IESCO not below the rank of Dy. Director (Inspection)</p> <p>v) Certificate issued by the Chief Engineer (MM), IESCO Islamabad regarding acceptance of Performance Bond (in case of first claim only)</p> <p>vi) Certificate from Excise &amp; Taxation Department, certifying the fact that all payable professional taxes have been cleared by the supplier.</p> <p>vii) General Sales Tax Invoice.</p> <p>viii) Certificate issued from consignee store Manager that material received vide GRN No. ___ dated ___ has been taken on stock against stock code No. ___</p> <p>The payment of amount of 18% General Sales Tax i.e. Rs. _____/- in the Letter of Credit shall be available for negotiation and en-cashable on production of General Sales Tax invoice and General Sales Tax return cum payment challan, as envisaged in clause 1-B(b) of P.O.</p> <p><b>Note:-</b> i) All these documents enumerated in payment clause of P.O shall however, be got pre-audited by Finance Director IESCO before invoking the L/C and release of payment by the bank.</p> <p>ii) The expenditure will be charged to _____.</p> <p>iii) Partial deliveries and part payments are allowed.</p> <p>Moreover, the payment of Sales Tax @ 18% shall be made on production of Sales Tax Invoice and Sales Tax return cum payment Challan along with Sale Summary. Amount of sales tax invoice must be cross-verified from sales summary filed to FBR along with sales tax return. In case you pay lump sum Sales Tax for multi goods production, you will also submit an affidavit on non-judicial paper that "the challan includes the amount of Rs. _____ of sales tax for supply of _____ against P.O No. _____ dated_____.</p> <p>Note:- Partial deliveries and part payments are allowed but not advance payment.</p>
<b>Delays in Supplier's Performance (GCC Clause 14)</b>		
5.	14.3	<p>a) Extension of Time shall be considered by the Procuring Agency (PA) on following grounds:</p> <p>1) If delay is beyond the control of the Supplier and it is claimed that circumstances fall under the FORCE MAJEURE clause, extension may be allowed in the delivery period without imposing penalty i.e. liquidated damages as mentioned in the contract.</p> <p>2) If delay is on the part of inspector nominated by IESCO at the time of inspection call.</p> <p>* The supplier is bound to submit its request for extension within 15 days from the occurrence of such event.</p> <p>b) Extension of Time shall not be considered by the Procuring Agency (PA) for the following reasons.</p> <p>1) Contractor does not issue inspection call as per GCC clause - 11.1.</p> <p>2) Delay on the part of the contractor in the arrangement of raw materials.</p> <p>3) Defect or failure occurring to any machinery or equipment installed at the contractor works during the currency of the contract.</p> <p>4) Any other delay caused by the contractor or its person (s) without notification to purchaser.</p> <p>The extension in the delivery period is not allowed as a matter of routine as and when demanded by the Suppliers. Only in exceptional cases, an extension be granted in the delivery schedule as mentioned above.</p>
<b>Liquidated Damages (GCC Clause 22)</b>		
6.	22.1	<p>To recover from you liquidated damages levied at the rate of (0.06%) per day or a fraction thereof subject to a maximum of ten percent (10%) of the Contract price (Liquidated damages will be deducted only on those materials which are undelivered during contract delivery period), except:</p> <p>a. Where un-delivered stores (material) hold up the use of other stores (material), liquidated damages shall be levied on the total value of the Contract.</p> <p>b. The recovery of liquidated damages mentioned above can be effected from any payment due to you from any unit of DISCOs or NTDC</p>
<b>Termination for Default (GCC Clause 15)</b>		

7.	15.1	<p>If you fail to deliver the stores or any consignment thereof within the specified delivery period, the purchaser shall be entitled at his option either:-</p> <ul style="list-style-type: none"> <li>i) To recover liquidated damages as prescribed in SCC Clause no. 26</li> <li>ii) To purchase from elsewhere without notice to you at your risk and cost, the stores not delivered, without canceling the contract in respect of the consignment not yet due for delivery, or</li> <li>iii) To cancel the contract at your risk and cost.</li> </ul> <p>In the event of action being taken under (ii) or (iii) above, you shall be liable for any loss which the purchaser may suffer on that account, but you shall not be entitled to any gain on repurchase made against the supply order. Moreover, if the maximum limit of LD is reached the Procuring Agency may consider termination of contract.</p> <p>(B) If during the course of execution of Contract, you are black-listed by GENCOs/WAPDA/DISCOs/NTDC/IESCO, the purchaser may proceed with all or any of the actions detailed below:-</p> <ul style="list-style-type: none"> <li>i) To allow the contract to run its course till completed in accordance with the terms and conditions of Contract.</li> <li>ii) To stop further supplies with or without financial repercussions.</li> <li>iii) To cancel the contract with or without reservation of rights.</li> </ul> <p>(C) You may be blacklisted / debarred from future business with IESCO/DISCOs on the following grounds including the ones prescribed in the IESCO mechanism of blacklisting &amp; PPRA Rules:</p> <ul style="list-style-type: none"> <li>i) Making false statements and allegations to gain undue advantage.</li> <li>ii) Commission of fraud.</li> <li>iii) Fail to perform the contractual obligations.</li> <li>iv) Fail to fulfill the technical provision of the Purchase Order during the execution of contract or breaches the contract.</li> <li>v) Fail to deliver the material as per the delivery schedule mentioned in the Purchase Order.</li> <li>vi) Commission of embezzlement, criminal breach of trust, theft, cheating, forgery, bribery, falsification or destruction of records, receiving stolen property, false use of a trademark, securing fraudulent registration, giving false evidence, furnishing of false information of serious nature</li> </ul> <p>IESCO Mechanism for Blacklisting of contractor/supplier/manufacturer/consultant/firm available on IESCO's website.  <a href="https://iesco.com.pk/images/downloads/Final-SOP-for-Blacklisting-Original-27-12-2019.pdf">https://iesco.com.pk/images/downloads/Final-SOP-for-Blacklisting-Original-27-12-2019.pdf</a>  Moreover, the procedure/timelines for the blacklisting of the contractor/supplier/manufacturer/consultant/firm will be in accordance with the PPRA Rule-19.  <i>It will be presumed that bidder has gone through the contents and is agreed with IESCO mechanism available on IESCO's Website.</i></p>
<b>Force Majeure (GCC-14)</b>		
8.		<p>The right of the IESCO to terminate the Contract, or to claim penalty or to liquidated damages shall be subject to the following circumstances, provided as a result of all or any of these events there has been delay in the performance of the contract by the Manufacturer or Supplier, or the contract has become incapable of being performed:-</p> <ul style="list-style-type: none"> <li>i) Act of God.</li> <li>ii) Act of State, War or any Act of the Enemy.</li> <li>iii) Lock outs, Riots or Civil Commotion.</li> <li>iv) Injunction granted by a Court of Competent jurisdiction not resulting from any fault of the Manufacturer or Suppliers.</li> <li>v) Restriction imposed by the government on the Import of any material relating to the manufacture of goods.</li> <li>vi) Non-receipt of raw material from abroad for reasons beyond the control of the manufacturer.</li> <li>vii) Port delays due to bunker age or lighter age.</li> <li>viii) Diversions of supplies by the Carrier without any fault or knowledge of the manufacturer or supplier.</li> </ul> <p>Provided further that the Manufacturer/supplier has given notice to the IESCO within 14-days of the</p>

	happening of any such event.
<b>Packing</b>	
9.	The supplier will be responsible for packing the store suitable for transit by Rail / Road so as to ensure their being free from loss or damage on arrival at destination. The packing of the stores shall be done by and at supplier's expense in accordance with the standard specifications governing such packing. In case there are no standard specifications, goods will be packed according to the trade practice to ensure safe receipt at destination
<b>Warranty</b>	
10.	The supplier will furnish a Warranty Certificate, certifying that the goods supplied conform exactly to the Specifications laid down in the Contract and are brand new and that in the event of the material being found defective or not conforming to the Specifications/Particulars governing supply at the time of delivery and for a period of <b>24-months</b> from the date of completion of supply, the supplier will be held responsible for all losses and that the unacceptable goods shall be substituted with the acceptable at your expense & cost.
11.	The Bidder shall sign each page of IESCO Blacklisting Mechanism provided in the Bidding document in addition to PPRA Rule-19, which shall be the part of Contract Agreement.  For the Contracts/POs amounting to more than PKR 50 Million, the Supplier's " <b>Declaration of Beneficial Owner (s) Information as per PPRA SRO 592(I)/2022 dated 10.05.2022</b> " on prescribed proforma shall be part of the Contract agreement.
12.	The period for correction of defects in the warranty period is: <b>Fifteen (15) Days.</b>
13.	Procuring Agency's address for notice purposes:  <b>Chief Engineer (MM)</b> <b>IESCO Head office, Street No. 40,</b> <b>Sector G-7/4, Islamabad</b>  Supplier's address for notice purposes: _____ (To be provided after signing of Contract Agreement)

## Past Experience / Contracts

Contracts over *[insert amount]* during the last three years:

Procuring Agency	Value	Year	Goods/Services Supplied	Country of Destination



## Historical Contract Non-Performance, and Pending Litigation and Litigation History

*[The following table shall be filled in for the Applicant and for each member of a Joint Venture]*

Applicant's Name: *[insert full name]*

Date: *[insert day, month, year]*

Joint Venture Member Name: *[insert full name]*

IFP No. and title: *[insert IFP number and title]*

Page *[insert page number]* of *[insert total number]* pages

<input type="checkbox"/> Not debarred due to deviation from commitment of Bid Securing Declaration- <input type="checkbox"/> Not debarred due to non-performance			
Year	Non-performed portion of contract	Contract Identification	Total Contract Amount (current value, currency, exchange rate and PKR equivalent)
<i>[insert year]</i>	<i>[insert amount and percentage]</i>	Contract Identification: <i>[indicate complete contract name/ number, and any other identification]</i> Name of Procuring Agency: <i>[insert full name]</i> Address of Procuring Agency: <i>[insert street/city/country]</i> Reason(s) for nonperformance: <i>[indicate main reason(s)]</i>	<i>[insert amount]</i>
Pending Litigation, in accordance with Section III, Qualification Criteria and Requirements			
<input type="checkbox"/> Pending litigation in accordance with Section III, Qualification Criteria and Requirements, Sub-Factor 2.3 as indicated below.			
Year of dispute	Amount in dispute (currency)	Contract Identification	Total Contract Amount (currency), US\$ PKR Equivalent (exchange rate)

<i>[insert year]</i>	<i>[insert amount]</i>	<p>Contract Identification: [indicate complete contract name, number, and any other identification]  Name of Procuring Agency: <i>[insert full name]</i>  Address of Procuring Agency: <i>[insert street/city/country]</i>  Matter in dispute: <i>[indicate main issues in dispute]</i>  Party who initiated the dispute: <i>[indicate "Procuring Agency" or "Supplier"]</i>  Status of dispute: <i>[Indicate if it is being treated by the Adjudicator, under Arbitration or being dealt with by the Judiciary]</i></p>	<i>[insert amount]</i>
<input type="checkbox"/> No consistent history of court/arbitral award decisions in accordance with Section III, Qualification Criteria and Requirements, Sub-Factor 2.4. <input type="checkbox"/> Consistent history of court/arbitral award decisions in accordance with Section III, Qualification Criteria and Requirements, Sub-Factor 2.4 as indicated below.			
<b>Year of award</b>	<b>Outcome as percentage of Net Worth</b>	<b>Contract Identification</b>	<b>Total Contract Amount (currency), PKR Equivalent (exchange rate)</b>
<i>[insert year]</i>	<i>[insert percentage]</i>	<p>Contract Identification: [indicate complete contract name, number, and any other identification]  Name of Procuring Agency: <i>[insert full name]</i>  Address of Procuring Agency: <i>[insert street/city/country]</i>  Matter in dispute: <i>[indicate main issues in dispute]</i>  Party who initiated the dispute: <i>[indicate "Procuring Agency" or "Supplier"]</i>  Court/ arbitral award decision: <i>[Indicate if the award decision was against the Applicant or any member of a joint venture.]y]</i></p>	<i>[insert amount]</i>

## Current Contract Commitments / Works in Progress

Bidders and each member to a JV should provide information on their current commitments on all contracts that have been awarded, or for which a letter of intent or acceptance has been received, or for contracts approaching completion, but for which an unqualified, full completion certificate has yet to be issued.

<b>Current Contract Commitments</b>					
No.	Name of Contract	Employer's Contact Address, Tel, Fax	Value of Outstanding Work [Current Eq. PKR]	Estimated Completion Date	Average Monthly Invoicing Over Last Six Months [Eq. PKR/month]
1					
2					
3					
4					
5					

## Financial Situation and Performance

*[The following table shall be filled in for the Applicant and for each member of a Joint Venture]*

Applicant's Name: *[insert full name]*

Date: *[insert day, month, year]*

Joint Venture Member Name: *[insert full name]*

IFP No. and title: *[insert IFP number and title]*

Page *[insert page number]* of *[insert total number]* pages

### 1. Financial data

Type of Financial information in (currency)	Historic information for previous <i>[insert number]</i> years, <i>[insert in words]</i> (amount in currency, currency, exchange rate*, PKR equivalent)				
	Year 1	Year 2	Year 3		
Statement of Financial Position (Information from Balance Sheet)					
Total Assets (TA)					
Total Liabilities (TL)					
Total Equity/Net Worth (NW)					
Current Assets (CA)					
Current Liabilities (CL)					
Working Capital (WC)					
Information from Income Statement					
Total Revenue (TR)					
Profits Before Taxes (PBT)					
Cash Flow Information					
Cash Flow from Operating Activities					

\* Refer ITA 14 for the exchange rate

### 3. Financial documents

The Applicant and in case of JV, members of JV shall provide copies of financial statements for *[number]* years pursuant Section III, Qualifications Criteria and Requirements. The financial statements shall:

- (a) reflect the financial situation of the Applicant or in case of JV member, and not an affiliated entity (such as parent company or group member).
  - (b) be independently audited or certified in accordance with local legislation.
  - (c) be complete, including all notes to the financial statements.
  - (d) correspond to accounting periods already completed and audited.
- Attached are copies of financial statements<sup>1</sup> for the *[number]* years required above; and complying with the requirements.

---

<sup>1</sup> If the most recent set of financial statements is for a period earlier than 12 months from the date of Application, the reason for this should be justified.